

RICOH

Aficio

FAX 5000L

OPERATING INSTRUCTIONS

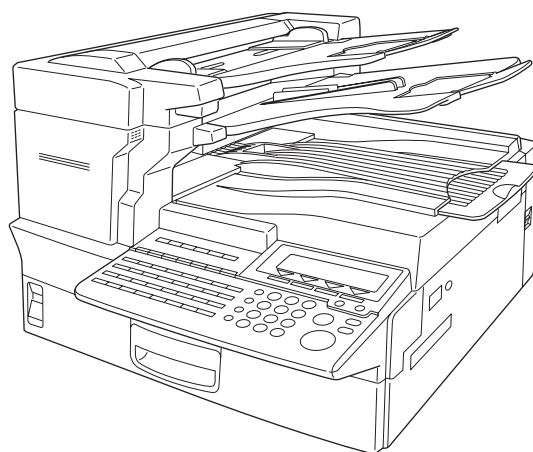

TKSH011E

Read this manual carefully before you use this product and keep it handy for future reference.

For safety, please follow the instructions in this manual.



RICOH COMPANY, LTD.

15-5, 1 chome, Minami-Aoyama, Minato-ku, Tokyo
Telephone: Tokyo 3479-3111

Ricoh shall not be responsible for any damage or expense that may result from the use of parts other than recommended parts.

TONER CASSETTES

RICOH FAX TONER CARTRIDGE TYPE 5210 is recommended for the best performance.

Overseas Affiliates

U.S.A.

RICOH CORPORATION
5 Dedrick Place
West Caldwell, New Jersey 07006
Phone: +1-973-882-2000

The Netherlands

RICOH EUROPE B.V.
Groenelaan 3, 1186 AA, Amstelveen
Phone: +31-(0)20-5474111

United Kingdom

RICOH UK LTD.
Ricoh House,
1 Plane Tree Crescent, Feltham,
Middlesex, TW13 7HG
Phone: +44-(0)181-261-4000

Germany

RICOH DEUTSCHLAND GmbH
Mergenthalerallee 38-40,
65760 Eschborn
Phone: +49-(0)6196-9060

France

RICOH FRANCE S.A.
383, Avenue du Général de Gaulle
BP 307-92143 Clamart Cedex
Phone: +33-(0)1-40-94-38-38

Spain

RICOH ESPAÑA S.A.
Avda. Litoral Mar, 12-14,
08005 Barcelona
Phone: +34-(0)93-295-7600

Italy

RICOH ITALIA SpA
Via della Metallurgia 12,
37139 Verona
Phone: +39-045-8181500

Hong Kong

RICOH HONG KONG LTD.
23/F., China Overseas Building,
139, Hennessy Road,
Wan Chai, Hong Kong
Phone: +852-2862-2888

Singapore

RICOH ASIA PACIFIC PTE.LTD.
260 Orchard Road,
#15-01/02 The Heeren,
Singapore 238855
Phone: +65-830-5888

Introduction

This manual contains detailed instructions on the operation and maintenance of this machine. To get maximum versatility from this machine all operators should carefully read and follow the instructions in this manual. Please keep this manual in a handy place near the machine.

Please read the Safety Information before using this machine. It contains important information related to USER SAFETY and PREVENTING EQUIPMENT PROBLEMS.

Notes:

Some illustrations might be slightly different from your machine.

Certain options might not be available in some countries. For details, please contact your local dealer.

Laser Safety:

The optical housing unit can only be repaired in a factory or at a location with the requisite equipment. The laser subsystem is replaceable in the field by a qualified Customer Engineer. The laser chassis is not repairable in the field. Customer engineers are therefore directed to return all chassis and laser subsystems to the factory or service depot when replacement of the optical subsystem is required.

Caution:

Use of controls or adjustments or performance of procedures other than those specified in this manual may result in hazardous laser radiation exposure.

Notes:

Two kinds of size notation are employed in this manual. With this machine refer to the inch version.

For good copy quality, Ricoh recommends that you use genuine Ricoh toner.

Ricoh shall not be responsible for any damage or expense that might result from the use of parts other than genuine Ricoh parts in your Ricoh office product.

Important

Parts of this manual are subject to change without prior notice. In no event will the company be liable for direct, indirect, special, incidental, or consequential damages as a result of handling or operating the machine.

Power Source:

AC187–276V, 50Hz

Please be sure to connect the power cord to a power source as above.

C € 0682 X

The interface complies with the requirements of the Commission Decision 98/515/EC.

98/515/EC:★ Commission Decision of 17 June 1998 on a common technical regulation for the pan-European integrated service digital network (ISDN) basic access (Amendment1).



Declaration of Conformity

“The Product complies with the requirements of the EMC Directive 89/336/EEC and the Low Voltage Directive 73/23/EEC.”

In accordance with IEC 60417, this machine uses the following symbols for the main power switch:

I means **POWER ON.**

O means **POWER OFF.**

Notice

⚠ CAUTION:

Shielded interconnect cables must be employed with this equipment to ensure compliance with the pertinent RF emission limits governing this device.

Although this equipment can use either loop disconnect or DTMF signalling, only the performance of the DTMF signalling is subject to regulatory requirements for correct operation. It is therefore strongly recommended that the equipment is set to use DTMF signalling for access to public or private emergency services. DTMF signalling also provides faster call set up.

Safety Information

When using your equipment, the following safety precautions should always be followed.

Safety During Operation

In this manual, the following important symbols are used:

⚠ WARNING:
Indicates a potentially hazardous situation which, if instructions are not followed, could result in death or serious injury.

⚠ CAUTION:
Indicates a potentially hazardous situation which, if instructions are not followed, may result in minor or moderate injury or damage to property.

⚠ WARNING:

- **Connect the power cord directly into a wall outlet and never use an extension cord.**
- **Disconnect the power plug (by pulling the plug, not the cable) if the power cable or plug becomes frayed or otherwise damaged.**
- **To avoid hazardous electric shock or laser radiation exposure, do not remove any covers or screws other than those specified in this manual.**
- **Turn off the power and disconnect the power plug (by pulling the plug, not the cable) if any of the following conditions exists:**
 - **You spill something into the equipment.**
 - **You suspect that your equipment needs service or repair.**
 - **Your equipment's cover has been damaged.**
- **Do not incinerate spilled toner or used toner. Toner dust might ignite when exposed to an open flame.**
- **Disposal can take place at our authorized dealer or at appropriate collection sites.**
- **Dispose of the used toner cartridge in accordance with the local regulation.**

⚠ CAUTION:

- *Protect the equipment from dampness or wet weather, such as rain, snow, and so on.*
- *Unplug the power cord from the wall outlet before you move the equipment. While moving the equipment, you should take care that the power cord will not be damaged under the equipment.*
- *When you disconnect the power plug from the wall outlet, always pull the plug (not the cable).*
- *Do not allow paper clips, staples, or other small metallic objects to fall inside the equipment.*
- *Keep toner (used or unused) and toner cartridge out of the reach of children.*
- *For environmental reasons, do not dispose of the equipment or expended supply waste at household waste collection points. Disposal can take place at an authorized dealer or at appropriate collection sites.*
- *The inside of the machine could be very hot. Do not touch the parts with a label indicating the "hot surface". Otherwise it could cause a personal burn.*
- *Our products are engineered to meet high standards of quality and functionality, and we recommend that you only use the expendable supplies available at an authorized dealer.*

Important Safety Instructions

Grounding

In order to prevent potentially hazardous electrical shock, provide means of connecting to the protective grounding conductor in the building, wiring those grounding conductors of power cable and 3 pins plug.

ENERGY STAR Program

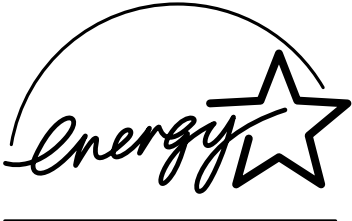
<p>ENERGY STAR®</p> 	<p>As an ENERGY STAR Partner, we have determined that this machine model meets the ENERGY STAR Guidelines for energy efficiency.</p>
---	--

The ENERGY STAR Guidelines intend to establish an international energy-saving system for developing and introducing energy-efficient office equipment to deal with environmental issues, such as global warming.

When a product meets the ENERGY STAR Guidelines for energy efficiency, the Partner shall place the ENERGY STAR logo onto the machine model.

This product was designed to reduce the environmental impact associated with office equipment by means of energy-saving features, such as Low-power mode.

- **Low-power Mode**

This product automatically lowers its power consumption 1 minute after the last hard copy has been completed. (In this mode, printing a received fax and printing are available.)

To exit Low-power mode, press the **[Clear Modes/Energy Saver]** key.

The machine returns to the ready condition in about 30 seconds.

For how to change the default interval before entering Low-power mode, see P.28 "Entering Energy Saver Mode".

◆ Specification

Low-power mode	Power consumption	2.0W
	Default Time	5min.



Recycled Paper

Please contact your sales or service representative for recommended recycled paper types that may be used in this machine.

How to Read this Manual

How to Read this Manual

Symbols

In this manual, the following symbols are used:

 **WARNING:**

This symbol indicates a potentially hazardous situation that might result in death or serious injury when you misuse the machine without following the instructions under this symbol. Be sure to read the instructions, all of which are described in the Safety Information section.

 **CAUTION:**

This symbol indicates a potentially hazardous situation that might result in minor or moderate injury or property damage that does not involve personal injury when you misuse the machine without following the instructions under this symbol. Be sure to read the instructions, all of which are described in the Safety Information section.

* The statements above are notes for your safety.

 **Important**

If this instruction is not followed, paper might be misfed, originals might be damaged, or data might be lost. Be sure to read this.

 **Preparation**

This symbol indicates the prior knowledge or preparations required before operating.

 **Note**

This symbol indicates precautions for operation, or actions to take after misoperation.

 **Limitation**

This symbol indicates numerical limits, functions that cannot be used together, or conditions in which a particular function cannot be used.

 **Reference**

This symbol indicates a reference.

[]

Keys that appear on the machine's panel display.

[]

Keys built into the machine's operation panel.

Frequently Asked Questions

How do I check whether a fax transmission was successful or not?

Check the communication result on the display.

⇒ P.138 *“Checking the Transmission Result (TX Status)”*

Is it possible to specify several destinations at once?

Yes. Storing numbers in a Group beforehand lets you quickly and easily specify multiple destinations in a single operation.

⇒ P.78 *“Dialing with Groups”*

How do I confirm exactly where my fax is being sent?

With Immediate Transmission you can monitor the status of the transmission at the machine.

⇒ P.57 *“Immediate Transmission”*

How can I quickly recognize received messages?

Have each page of received documents automatically marked.

⇒ P.100 *“Checkered Mark”*

I have to send a fax at a specific time, but I will not be in the office then. What can I do?

Specify the transmission time to suit you or the other party.

⇒ P.106 *“Send Later”*

Can I redial a number?

Yes. The machine remembers the last 10 destinations so you do not have to enter recently dialed numbers again.

⇒ P.80 *“Redialing Numbers”*

Is there any way I can cut down on my telephone bill a little?

Specify messages to be sent automatically at an off-peak time when telephone charges are cheaper.

⇒ P.106 *“Send Later”*

TABLE OF CONTENTS

1. Getting Started

Guide to Components	15
Main Body	15
Internal View	18
Operation Panel	20
Display Layout	23
Display and key Operations	23
Example Displays	25
Standby Display	25
Communication Display	25
Display Prompts	25
Setup	27
Introduction	27
Choosing the Machine Location	27
Installing the Machine	28
Loading Paper	30
Adjusting Initial Settings	32
Handy Functions	39
Energy Saver Mode	39
Adjusting the Printing Density	41
Boxes	41
Restricted Access	44
TX/RX File Save Function	45
Multi-Port Unit (Option)	46
Acceptable Types Of Documents	47
Acceptable Document Sizes	47
Paper Size and Scanned Area	48
How to Set a Document	50
Direction in Which Original is Set	50
Setting Documents in the Auto Document Feeder (ADF)	50
Setting Paper in the Document Bypass Tray	51
Recommended Paper	53
Acceptable Copy Paper Sizes and Types	53
Unacceptable Paper Types	53
Changing the Paper Size	54
Changing the Paper Size in the Main Paper Tray	54
Changing the Paper Size in the Optional Paper Supply Unit	56

2. Sending a Fax Message

Overview	59
Overview	59

Memory Transmission	60
File Reserve Report (Memory Transmission)	64
Communication Result Report (Memory Transmission)	65
Communication Failure Report	65
Canceling a Memory Transmission	66
Mission Before the Document is Scanned in	66
Canceling a Transmission while the Document is Being Scanned in	66
Canceling a Transmission while the Machine is Dialing	67
Canceling a Transmission while the Message is Being Sent.....	67
Canceling a Fax that is Awaiting Transmission.....	68
Immediate Transmission	69
Transmission Result Report	71
Canceling an Immediate Transmission	72
On-Hook Dial.....	73
Using On Hook Dial with ISDN.....	73
Manual Dial.....	75
Scan Settings.....	76
Resolution	76
Image Density	77
Halftone.....	77
Mixing Scan Settings in a Multiple Page Document.....	77
Selecting the Line.....	79
How to Select the Line	80
Dialing.....	81
Number Keys.....	81
Dialing with Quick Dials.....	88
Dialing with Speed Dials	88
Dialing with Groups	90
Redialing Numbers.....	92
Sending a Fax Using a Program	94
Transmission Features	96
No Document, No Dial	96
Stamp.....	96
Auto Reduction.....	97
Duplex Original Settings.....	97
Label Insertion.....	98
Auto Document	98
TTI/CIL Print.....	99
ID Transmission	99
Skip Transmission.....	99
Backup File Transmission.....	100
JBIG Transmission.....	100

3. Receiving a Fax Message

Immediate Reception	101
Memory Reception	102
Substitute Reception	103
Screening Messages From Anonymous Senders	103
Selecting the Reception Mode	105
Fax Mode (Auto Receive Mode)	105
Telephone Mode	105
How to Select the Reception Mode.....	105
Reception Functions	106
Transfer Station.....	106
Transfer Result Report.....	107
Remote Transfer	107
Remote Transfer with UI.....	109
ID Reception	110
JBIG Reception	110
Authorized Reception.....	110
Specified Tray	110
Forwarding	111
Printing Functions	112
Checkered Mark.....	112
Center Mark	112
Reception Time	112
Collate	113
Two In One.....	113
Image Rotation.....	114
Rotate Sort	114
Page Separation and Length Reduction (Not Available in Some Countries) ...	115
TSI Print	115
CIL/TID Print	115
When there is No Paper of the Correct Size	116

4. Advanced Transmission Features

Overview	117
Overview	117
Send Later	118
Confidential Transmission	120
Personal Code Transmission	122
Entering a Personal Code with a Quick Dial Key	123
SUB Code Transmission with the Mode Key	125
SEP Code Polling Reception	128
Polling Reception	131

File Reserve Report (Polling Reception)	133
Communication Result Report (Polling Reception)	133
Polling Transmission	134
Polling Transmission Clear Report.....	137
Transfer Request.....	138
Specifying an End Receiver	140
TTI Print.....	141

5. Communication Information

Checking and Canceling Transmission Files	143
Canceling a Transmission.....	143
Printing a File	144
Checking and Editing a File	145
Printing a List of Files in Memory (Print TX File List)	149
Checking the Transmission Result (TX Status).....	150
Checking the Reception Result (RX Status)	151
Printing a Confidential Message.....	152
Confidential File Report.....	153
Printing a File Received with Memory Lock.....	154
Printing the Journal.....	156
Displaying the Files in Memory.....	159
TX/RX File Save	160
Searching Memory for Sent Faxes.....	161
Searching Memory for Received Faxes	163
Disk File Search List/Visual List	166
Printing Files	166
Deleting Files	167
Box File Manager Functions.....	169
Printing Personal Box Messages	169
Storing Messages in Information Boxes.....	170
Printing Information Box Messages	171
Deleting Information Box Messages	173

6. Copying

Copying	175
----------------------	------------

7. Troubleshooting

Solving Problems	177
Error Messages and Their Meanings.....	179
Clearing Document Jams	180
Clearing Document Jams in the ADF	180

Clearing Document Jams in the Bypass Tray	181
Clearing Paper Jams	182
Clearing Paper Jams in the Fusing Unit.....	182
Clearing Paper Jams in the Main Paper Tray	183
Clearing Paper Jams in the Optional Paper Supply Unit	184
Replacing the Toner Cartridge	186
Indicators	188
When the Receive File Indicator is Lit.....	188
☑ When the Confidential Reception/Memory Lock Indicator is Lit or Flashing	188
☐ When the Cover Open Warning Indicator is Lit	189
% When the Paper Jammed Indicator is Lit	189
⬇ When the Add Toner Indicator is Lit or Flashing	189
☒ When the Paper Supply Indicator is Lit	190
⤴ When the Call Service Indicator is Lit	190
When an Error Report is Printed.....	191
When Power is Turned Off or Fails.....	192

8. Fax Features

Fax Features	193
Program/Delete Menu.....	194
Registering Quick Dials	194
Deleting Quick Dials	197
Registering Groups	199
Deleting Groups	208
Registering Speed Dials.....	209
Deleting Speed Dials.....	212
Storing Keystroke Programs	213
Deleting a Keystroke Program	217
Registering Auto Documents	218
Deleting an Auto Document	221
Reports/Lists.....	223
Assigning User Function Keys	225
Registering/Editing the Contents of a User Function Key	225
Programming a User Function Key on the Job	226
Functions You Can Store in a User Function Key	227
Utilizing User Function Keys	227
Deleting Functions Stored in User Function Keys.....	228
Fax On Demand	230
Registering/Editing Fax On Demand Documents	230
Deleting Fax On Demand Documents	232
Printing Fax On Demand Documents	234
Printing the Fax On Demand List	235
Printing the Fax On Demand Access Report	236
Fax On Demand Recorded Messages	237

9. Key Operator Tools

Key Operator Tools	243
System Settings	244
Counters.....	244
Monitor Volume	245
Adjusting the Display Contrast	246
Date/Time.....	247
Summer Time/DST	247
Registering the Economy Transmission Time	247
Night Timer.....	248
Changing the User Parameters.....	250
File Retention	258
RTI/TTI	259
G3-1 Analog Line	259
G3-2 Analog Line	261
G3 Digital Line.....	262
G4 Digital Line.....	264
Registering ID Codes	266
Transfer Report.....	268
Network Settings	269
System Parameter Transmission	270
Memory File Transfer	270
Reset PM Counters.....	271
RDS (Remote Diagnostic System).....	273
Initial Set Up	275
Opening the Initial Set Up Menu	276
Collate	276
(Printing Multiple Copies of Messages From Certain Senders)	
Authorized Reception.....	278
(Blocking Out Messages from Certain Senders)	
Specified Tray	281
(Having Messages from Certain Senders Printed on Different Paper)	
Forwarding	284
(Having Messages From Certain Senders Forwarded)	
Deleting Forwarding Addresses	288
Deleting Specified Senders (Forwarding)	289
Printing the Specified Sender List (Forwarding).....	291
Memory Lock.....	292
(Having Messages from Certain Senders Stored in Memory Instead of Being Printed Out)	
TX/RX File In HD.....	295
(Having Messages from Certain Senders Stored in Memory)	
Deleting Specified Senders.....	297
General Procedure for Deleting Specified Senders	
Printing the Specified Sender List	299
(General Procedure for Printing a List of Registered Specified Senders)	
How to Print Specified Sender List.....	299

Backup File Transmission Settings.....	300
(Specifying a Destination to Send Backups of Faxes)	
Program Scan Area.....	302
(Setting the Scan Area)	
Box Settings.....	304
Registering/Editing Personal Boxes.....	304
Deleting Personal Boxes.....	307
Registering/Editing Information Boxes.....	309
Deleting Information Boxes.....	311
Registering/Editing Transfer Boxes.....	312
Deleting Transfer Boxes.....	315
Printing the Box List.....	316

10.Entering and Modifying Text

Available Characters.....	319
Keys.....	320
How To Enter Text.....	322
Entering Letters.....	322
Entering Symbols.....	322
Entering Numbers.....	322
Deleting Characters.....	323

11.Maintaining Your Machine

Maintaining the Machine.....	325
Cleaning the Document Transport Mechanism.....	325
Cleaning the Copy Paper Transport Mechanism.....	326
Cleaning the Registration Roller.....	327
Maintenance Kits.....	327

12.Appendix

Options.....	333
Memory Cards.....	333
Optional Function Upgrade Card.....	333
Optional Fax On Demand.....	334
Installing the Memory Cards, Optional Function Upgrade Card and Fax On Demand Card.....	334
Optional G3 Unit.....	335
Optional G4 Unit.....	335
Optional NIC FAX Kit.....	336
Optional PC-FAX Expander.....	336
Optional Printer Interface.....	337
Other Options.....	337
Function List.....	338
Advanced Transmission Features.....	338

Communication Information	339
Fax Features	340
Key Operator Tools	342
Specifications	346
Laser Label.....	347
Position of the Laser Label.....	347
INDEX.....	349

1. Getting Started

Guide to Components

Main Body

Front view

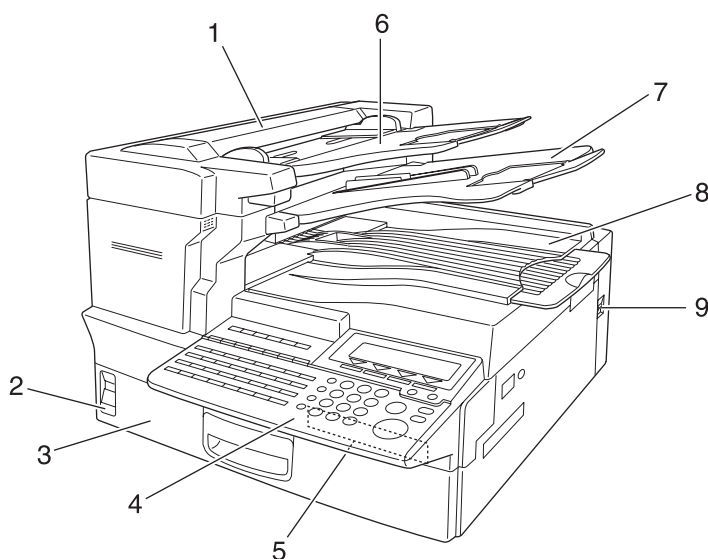

TKSH020E

1. Auto Document Feeder (ADF)

Set multi-page documents here to have them automatically scanned in one page at a time.

2. Paper Supply Indicator

Lights red when paper has run out.

3. Main Paper Tray

Load blank paper here.

4. Operation Panel

5. Optional Card Insertion Slots

Left slot—insert the optional Function Upgrade Card here

Right slot—insert the optional Memory Card or optional Fax On Demand Card here

6. Document Tray

7. Document Output Tray

Scanned documents are stacked here.

8. Output Tray

Copies and incoming faxes are stacked here.

9. Power Switch

Use to turn the power on or off.

Rear view

1

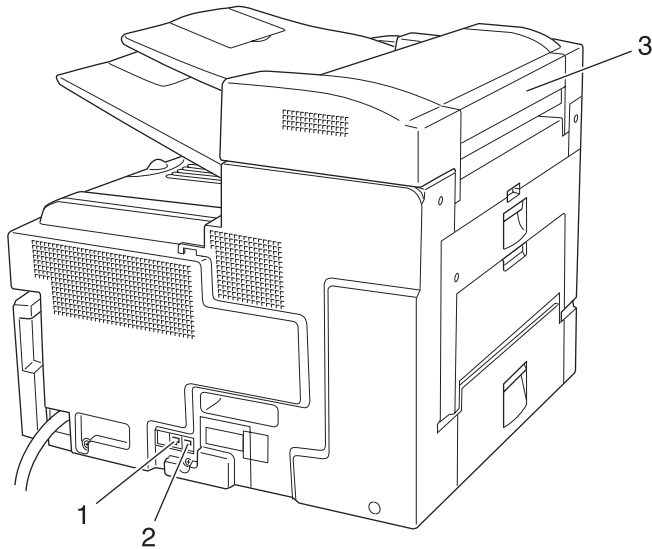

TKSH030E

1. External Telephone Connector

2. Telephone Line Connector

3. Document Bypass Tray

Load non-standard size blank paper here.

When the optional Paper Supply Unit is installed

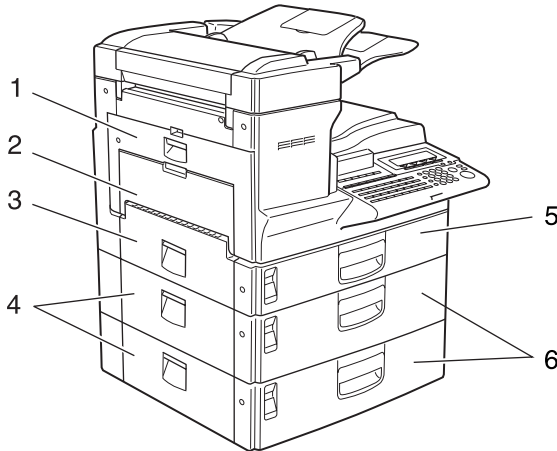

TKSH040N

1. Main Side Cover

Open this cover when changing the toner cartridge or installing the fusing unit maintenance kit.

⇒ P.186 *"Replacing the Toner Cartridge"*

⇒ P.329 *"Installing the Fusing Unit Maintenance Kit"*

2. Bypass Tray

Use when the optional Printer Interface is installed. ⇒ Please refer to the Printer Interface manual for details.

3. Paper Tray Side Cover

Open to clear paper jams.

⇒ P.182 *"Clearing Paper Jams"*

4. Paper Supply Unit Side Cover

Open to clear paper jams.

⇒ P.184 *"Clearing Paper Jams in the Optional Paper Supply Unit"*

5. Main Paper Tray**6. Optional Paper Supply Unit**

Provides an extra paper source in addition to the main paper tray. You can install up to two of these units.

Internal View

View with Main Side Cover open

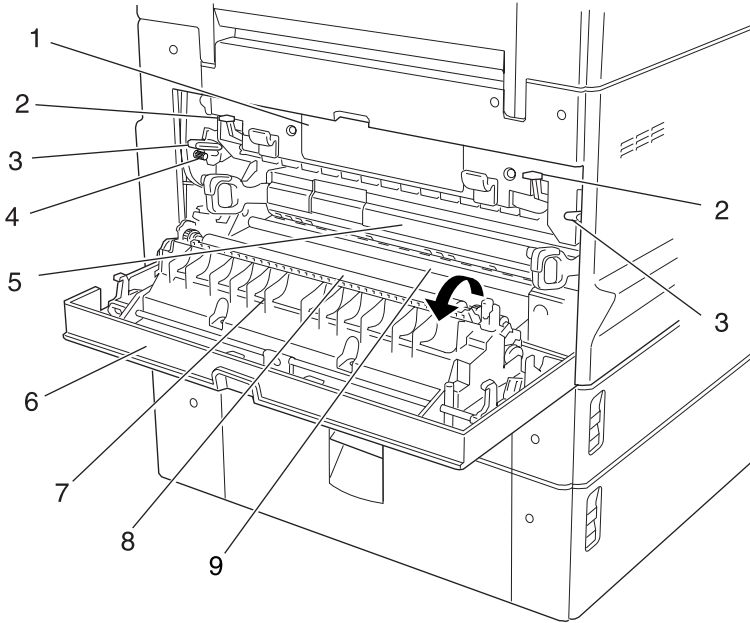

TKSH100N

1. Fusing Unit

Fuses the toner to the paper. Replace this unit if a message asking you to do so appears on the display.

⇒ Installing the fusing unit maintenance kit.

2. Pressure Release Levers

Lower these transparent levers to remove jammed paper.

3. Fusing Unit Fixed Levers

Lower these levers when installing the fusing unit maintenance kit.

4. Screw

Remove these green screws when lowering the fusing unit fixed levers to install the fusing unit maintenance kit.

5. Toner Cartridge

Replace the toner cartridge when a message appears on the display instructing you to do so.

⇒ P.186 *“Replacing the Toner Cartridge”*

6. Main Side Cover

Open to clear paper jams and replace the toner cartridge etc.

7. Transfer Roller Cover

Open to replace the transfer roller.

⇒ P.329 *“Installing the Fusing Unit Maintenance Kit”*

8. Transfer Roller

Replace when installing the fusing unit maintenance kit.

⇒ P.329 *“Installing the Fusing Unit Maintenance Kit”*

9. Corona Roller

⇒ P.327 "Cleaning the Registration Roller"

This feeds the paper. Clean this roller if it gets dirty.

View with the ADF cover open

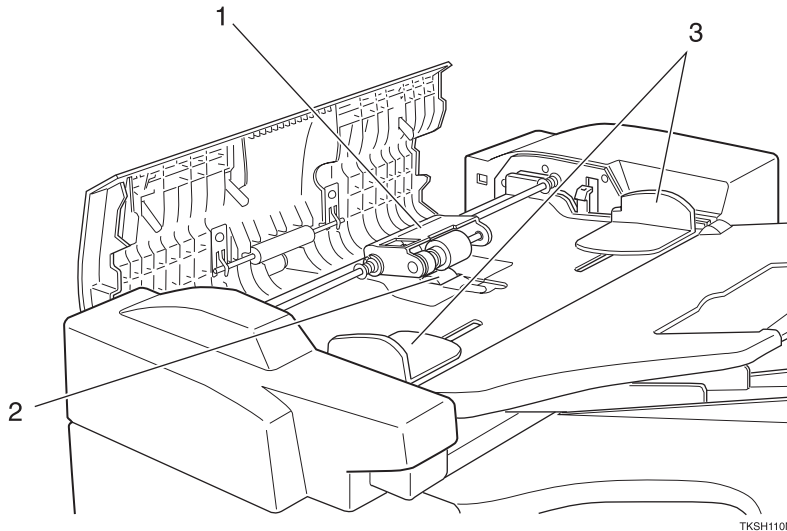

1. Feed Unit

Feeds in documents. Replace when installing the ADF unit maintenance kit.

⇒ P.328 "Installing the ADF Unit Maintenance Kit"

2. Separation Roller

Pages are fed in between this roller and the feed unit. Replace when installing the ADF unit maintenance kit.

⇒ P.328 "Installing the ADF Unit Maintenance Kit"

3. Document Guides

Adjust these guides to match the size of your document.

Operation Panel

1

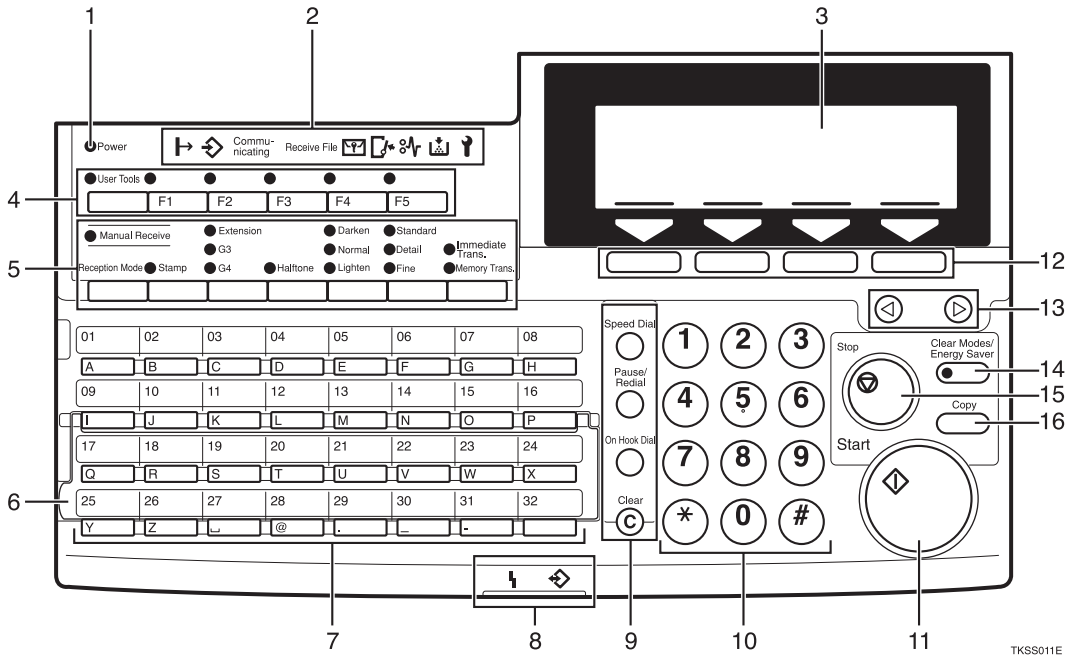

TKSS011E

1. Power Indicator

Lights when power is on. In Low Power Standby mode this indicator goes out.

2.

❖ Online Indicator

When the optional Printer Interface is installed, this indicator shows whether the machine is online (lit) or offline (unlit).

When online, the machine is ready to print data received from a PC.

❖ Data-in Indicator

When the optional Printer Interface is installed, this indicator flashes when the machine is receiving data from a PC. When lit, the machine is waiting for data from a PC.

❖ Communicating Indicator

Lights during reception or transmission.

❖ Receive File Indicator

Lights when a message has been received into memory with any function other than Confidential Reception.

⇒ P.103 "Substitute Reception"

❖ Confidential Reception/Memory Lock Indicator

Lights when a message has been received into memory with the Confidential Reception function.

⇒ P.152 "Printing a Confidential Message"

Flashes when a message has been received with the Memory Lock function.

⇒ P.154 "Printing a File Received with Memory Lock"

❖ Cover Open Warning Indicator

Lights if a cover is open. Make sure all covers are firmly closed.

❖  **Paper Jammed Indicator**

Lights if paper is jammed. Remove the jammed paper as instructed on the display.

❖  **Add Toner Indicator**

Flashes when toner is low, lights when toner has completely run out.
⇒ P.186 *"Replacing the Toner Cartridge"*

❖  **Call Service Indicator**

Lights to indicate the machine has broken down. If lit, please contact your service representative.

3. Display

Displays messages and the status of the machine.

4.❖ **【User Tools】 Key**

Press to access the User Tool settings and customize various functions to meet your specific requirements.
⇒ P.193 *"Fax Features"*
⇒ P.243 *"Key Operator Tools"*

❖ **User Function Keys**

You can store functions you often use in these keys and recall them with a single key press. When shipped, the following functions are registered by default:

Key	Function
【F1】	Journal Print
【F2】	TTI Print On/Off
【F3】	Group Dial
【F4】	Nothing
【F5】	Nothing

⇒ P.225 *"Assigning User Function Keys"*

5.❖ **Reception Mode Key**

When the indicator above this key is lit, the machine is in TEL mode. When it is unlit, the machine is in Auto Receive mode.
⇒ P.105 *"Selecting the Reception Mode"*

❖ **【Stamp】 Key**

Selects whether a mark is stamped on scanned documents.
⇒ P.96 *"Stamp"*

❖ **【Line Selection】 Key**

Press to select G3, G4 or extension.
⇒ P.79 *"Selecting the Line"*

❖ **【Halftone】 Key**

Select halftone when faxing or copying photographs or illustrations with fine gradations. Also can be used for color documents.
⇒ P.77 *"Halftone"*

❖ **【Image Density】 Key**

Press to adjust the brightness of scanned images when faxing or copying.
⇒ P.77 *"Image Density"*

❖ **【Resolution】 Key**

Press to select the level of detail to be sent.
⇒ P.76 *"Resolution"*

❖ **【Transmission Mode】 Key**

Press to select the fax transmission mode. The indicators above this key indicate the current mode.

6. Quick Dial Key Flip Plate

Flip down to access Quick Dials **【01】** – **【32】**, flip up to access Quick Dials **【33】** – **【64】**.

7. Quick Dial Keys

Fax numbers stored beforehand in these keys can be recalled with a single key-press. Also use to enter characters and with the Group and Program functions etc.

⇒ P.88 *"Dialing with Quick Dials"*

⇒ P.90 “Dialing with Groups”

⇒ P.213 “Storing Keystroke Programs”

8. Status Indicators

These indicators allow you to view the machine status from a distance.

❖ Alarm

Lights when an error has occurred. Check the display for details.

⇒ P.179 “Error Messages and Their Meanings”

❖ Communicating

Lights during fax transmission or reception. Also lights when the optional Printer Interface is installed and data is being printed.

⇒ Please refer to the optional Printer Interface manual for details.

9. [Speed Dial] Key

Press to specify a destination stored in a Speed Dial.

⇒ P.88 “Dialing with Speed Dials”

❖ [Pause/Redial] Key

Pause—press to insert a small delay between digits of a fax number. The first digit of a fax number cannot be a pause.

⇒ P.82 “Pause”

Redial—press to redial a recently dialed number.

⇒ P.92 “Redialing Numbers”

❖ [On Hook] Key

Use to dial in the same way as a telephone.

⇒ P.73 “On-Hook Dial”

❖ [Clear] Key

Press to delete a single character when entering numbers or other characters.

10. Number Keys

Press to enter digits, e.g. when dialing a fax number.

11. [Start] Key

Press to send a fax or start printing of a report etc.

12. Selection Keys

These keys match the keys shown on the display. Press them to select functions and choose settings etc.

13. Arrow Keys

Press to move the display cursor and make function selections.

14. [Clear Modes/Energy Saver] Key

- Reset—Cancel the current settings and return to the standby mode (except when accessing the User Tools).
- Energy Saver—Hold down this key for about 2 seconds to force the machine to enter Energy Saver mode. The machine automatically enters Energy Saver mode about 5 minutes after the last operation was carried out.
⇒ P.39 “Energy Saver Mode”

15. [Stop] Key

Press to stop an Immediate Transmission, scanning of a Memory Transmission, or a report being printed. Also can be used to delete entered characters.

16. [Copy] Key

Press when you wish to make copies.

⇒ P.175 “Copying”

Display Layout

The operation panel display shows information about the current operation, function menus and useful messages.

Important

- ❑ Do not subject the display to a shock or force of more than about 30N (about 3kgf) or it could be damaged.

Note

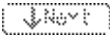
- ❑ Selected functions are shown white on black e.g. **Off**
- ❑ Functions you cannot select are shown grayed down e.g. 

Display and key Operations

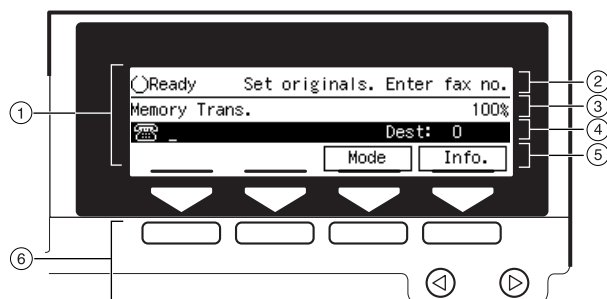

❖ Example 1: Standby display



TKSS031N

- ① The currently selected function
- ② Machine status and messages
- ③ Amount of free memory
- ④ Entered destination fax number and number of destinations entered so far
- ⑤ Selectable functions or options
- ⑥ Press these buttons to select the function or setting name that appears on the display immediately above each button

Note

- ❑ Each time you press  the selected item moves one position to the left.
- ❑ Each time you press  the selected item moves one position to the right.

❖ Example 2: Menu display

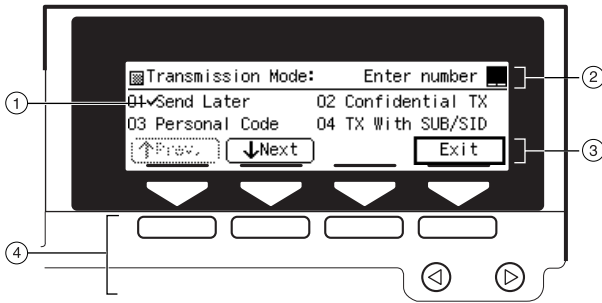

TKSS032N

① If you select a function, a ✓ mark will appear next to it.

Note

❑ Functions that are displayed differ according to installed options.

② Operation status and messages

③ Items or commands you can select.

④ Press these buttons to select the item or command that appears on the display immediately above each button.

Note

❑ Each time you press ⏪ the selected item moves one position to the left.

❑ Each time you press ⏩ the selected item moves one position to the right.

❖ Common keys

[Yes][OK]	Confirm the selected function or entered value, then return to the previous menu.
[No][Cancel]	Cancel the selected function or entered value, then return to the previous menu.
[↑Prev.][↓Next]	If there are more items that cannot fit on the display, use these keys to scroll through them.
⏪ ⏩	Use to select functions. The currently selected function is shown black on white.
[PrevMenu]	Return to the previous menu.
[Exit]	Confirm the selected function or entered value, then return to the standby display.

Example Displays

The display tells you the machine status and guides you through operations.

Note

- Functions that have been selected are highlighted as shown (**Off**). Keys that you can not select are shown with a dashed outline (**↓Next**).

Standby Display

While the machine is in the standby mode (immediately after it is turned on or after the **[Clear Modes/Energy Saver]** key is pressed), the following display is shown.





❖ Memory Transmission

<input type="radio"/> Ready	Set originals. Enter fax no.
Memory Trans.	100%
 Dest: 0	
	Mode Info.

❖ Immediate Transmission

<input type="radio"/> Ready	Set originals. Enter fax no.
Immediate TX	100%
 Dest: 0	
	Mode Info.

❖ Copy mode

 Copier Mode	Q'ty: 1
44  A3 	
	Select mode with 
Set original, press start	Exit

Note

- To return the machine to standby mode, perform one of the following:
 - If you have set a document and are in the sending process, remove the document.

- If you have not set a document and are in the sending process, press the **[Clear Modes/Energy Saver]** key.
- If you are in User Tools mode, press the **[User Tools]** key.

Communication Display

While the machine is communicating the communication status is displayed.

❖ Display during Memory Transmission or Memory Reception:

A4->A4	P.1	NEW YORK OFFICE
Memory Trans.		99%
 Dest: 0		
	Mode	Info.

Note

- Even when the machine is sending or receiving a fax message from/into memory, you can still scan the next document into memory.

❖ Immediate Transmission:

Sending...	3618
Please wait	
 3618	
	File No.0039

Display Prompts

Depending on the situation, the machine will show various prompts on the display.

❖ Instructions and requests

Send Later:	Enter time	
Start time	Time:14:00	
: (24hr format)		
Economy TX	Cancel	OK

❖ Questions

The transfer request has been set. Do you want to add another?	
Enter	No

❖ Selections

Language:	Select mode with
English / German / French	
Cancel	OK

❖ Status

Printing Please wait To stop, press Stop key
--

Setup

Introduction

The procedures in this section are intended to be carried out by a service representative.

The Setup section describes how to choose a suitable location for the machine and install various parts in preparation for turning on the power. In addition, it lists the basic settings that are necessary to get the machine up and running.

For how to get the most out of the advanced features of this product, please refer to the rest of this manual.

Important

- Before you continue, please take a few moments to read the safety information to avoid any damage to the machine or injury to yourself or others. see P.ii "Safety Information".

Choosing the Machine Location

For the best possible performance, install your machine in a place which satisfies the following conditions:

- Not exposed to direct sunlight.
- Well ventilated (air turnover at least three times per hour). To avoid buildup of ozone, install the machine in a large, well-ventilated room which has an air turnover of more than 30 cubic yards per hour per person.
- Level
- Not subject to vibration

- Away from other electronic equipment (to avoid interference)
- Away from areas exposed to corrosive gas
- Dust-free
- Condensation-free
- Temperature in the range 10°C – 32°C
- Humidity in the range 15%–80%
- Away from heaters and air conditioners in order to avoid sudden changes of temperature
- Within 5 yards of a three-pin grounded power outlet (187-276 volts, 50 Hz)
- Within the clearance shown below

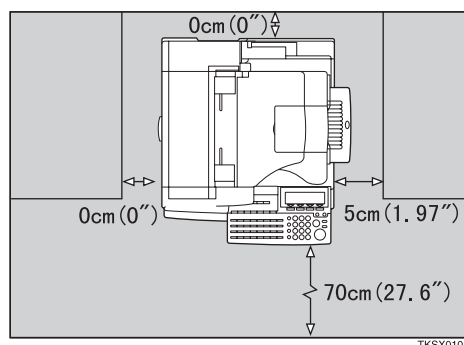

- At least 11.81" (30 cm) clearance to the left of the machine is necessary when clearing paper jams, changing the toner cartridge etc.

Installing the Machine

Fitting the Manual Pocket

Follow the steps below to fit the pocket for storing the Facsimile Quick Guide.

- 1** Squeeze in the release lever to unlock the ADF. Then lift up the ADF cover.

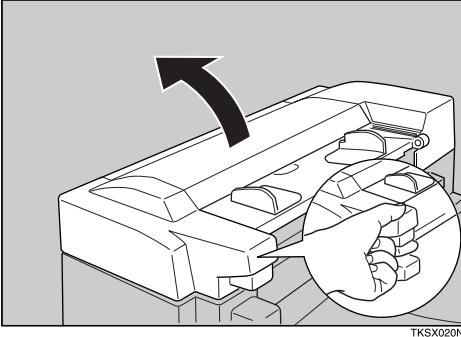

TKSX020N

- 2** While holding up the ADF cover, insert the manual pocket into the slot provided.

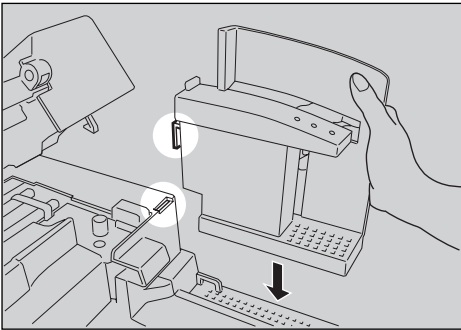

TKSX030N

- 3** Push down on the left and right sides of the ADF cover to close it. Make sure it clicks firmly into place.

Installing the Document Output Tray and Document Tray

- 1** Identify the document output tray (it is bigger than the other tray).

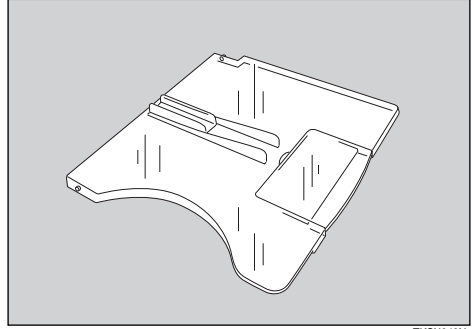

TKSX040N

- 2** With the frosted side facing up, bend the document output tray to insert it into the lower two slots provided.

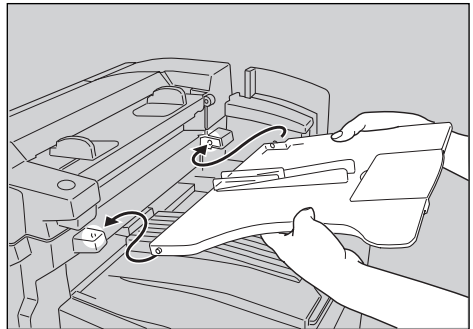

TKSX050N

- 3** Check the orientation of the document tray, then bend to insert it into the lower two slots provided.

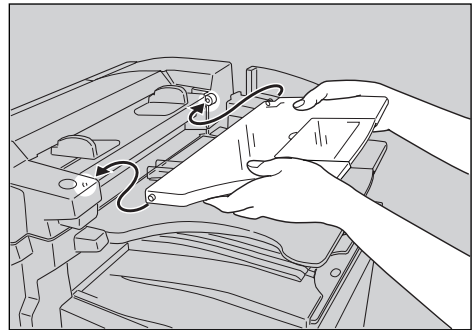

TKSX060N

- 4** If you regularly set large documents, pull out both tray extensions.

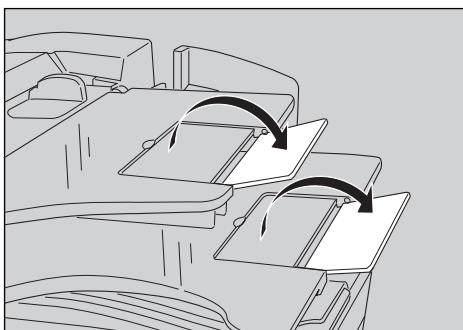

TKSX070N

Installing the Toner Cartridge

Important

- Be careful not to get toner on your hands or clothes. If you get toner on your hands, wash them thoroughly.

- 1** Open the main side cover in the direction of the arrow.

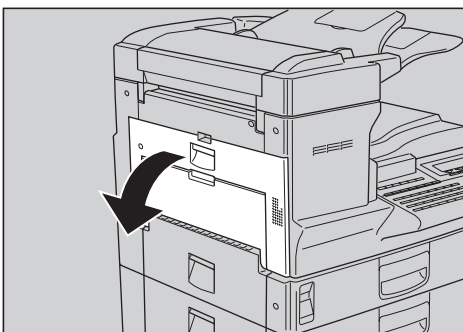

TKSY400N

- 2** While holding the cartridge horizontally, shake it gently from left to right and backwards and forwards about 7 or 8 times.

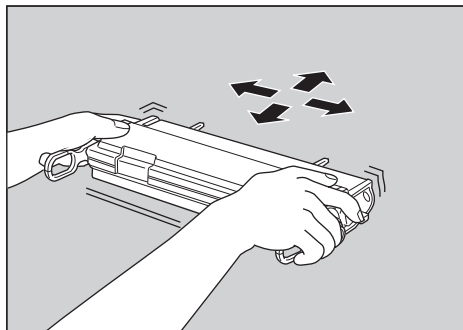

TKST020N

- 3** Place the toner cartridge on a flat surface. While supporting the cartridge with one hand, pull the toner seal horizontally to remove it.

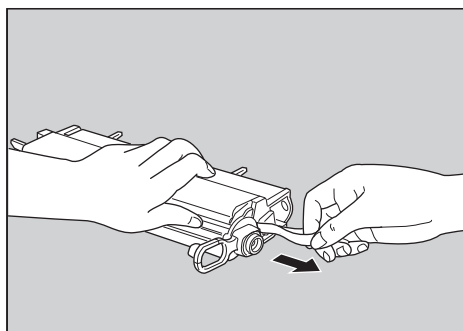

TKST030N

Important

- Using the cartridge without removing the seal could damage the machine. Always remove the seal before using a new cartridge.
- Be sure to pull the seal horizontally when removing it. Pulling it from above or below can cause toner to easily spill out.
- Once the seal is removed, toner can easily spill out, so pay attention not to shake or bump it.

- 4** Grasp the two handles at either end and push the cartridge into the machine.

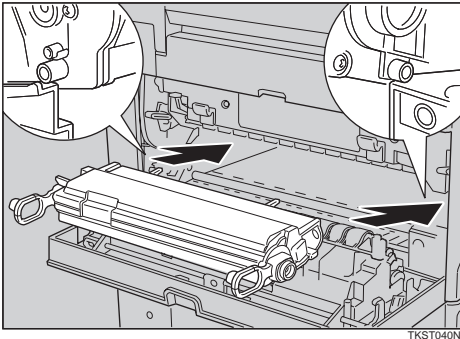

- 5** Close the main side cover making sure it clicks firmly into place.

Note

- The main side cover will not close properly if the toner cartridge is set into the machine incorrectly. If the cover will not close, remove the cartridge and set it again.

Connecting the machine to the telephone line

To connect the machine to a telephone line, use a snap-in modular type connector.

- TEL1: For the external telephone
- LINE: Telephone line connection

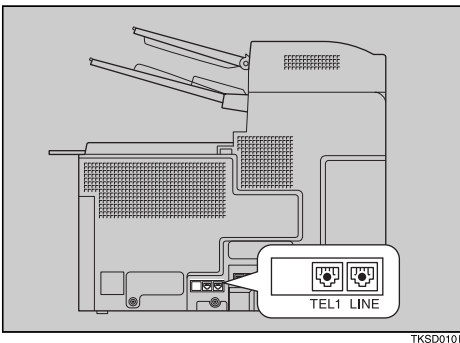

Important

- Make sure the modular connector is the correct type before plugging it in.

Attach the ferrite core

Loop the telephone cable and attach the ferrite core as shown in the illustration.

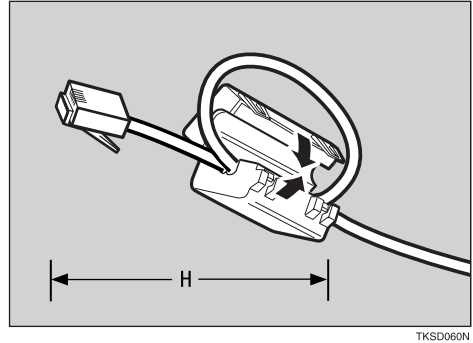

Note

- The telephone cable loop should be about 50 mm (H) from the end of the cable.

When using a modular type connector

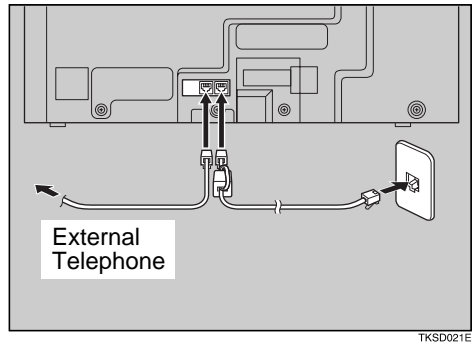

Connecting an External Telephone

You can connect an external telephone to the machine and use it for telephone calls.

Note

- ❑ Some types of telephone cannot be connected or may suffer reduced functionality.

Connecting the power and turning on

Important

- ❑ Make sure that the wall outlet is near the machine and readily accessible.
- ❑ The wall outlet must be easily accessible.

1 Plug the power cord to the power outlet.

2 Turn on the power switch.

Loading Paper

When paper runs out, follow one of the procedures below to load paper.

Note

- ❑ For acceptable paper types, directions, sizes and capacity, see P.53 "Recommended Paper".

Loading paper in the Main Paper Tray

Important

- ❑ Before you start, make sure the machine is not printing copies or receiving a fax.
- ❑ Do not reuse stapled paper, or use conductive paper, such as carbon paper or silver coated paper.

1 Pull out the paper tray as shown.

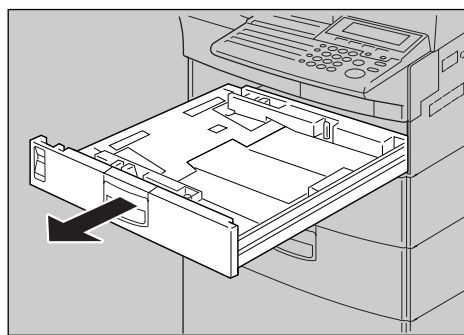

TKSY010N

2 Push down the base plate until it clicks into place.

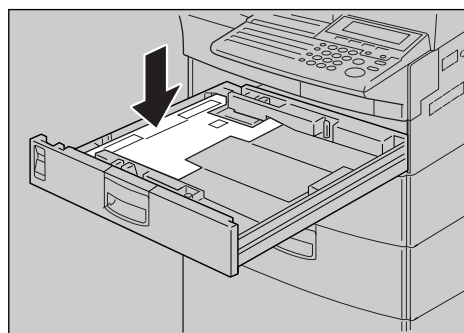

TKSY011N

3 Adjust the dial to match the paper size.

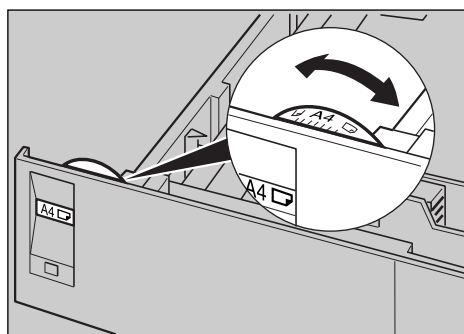

TKSY190N

1

Important

- ❑ If the dial does not match the size and direction of loaded paper, parts of printed images may be missing and paper jams could occur.

4 Prepare the new paper, then insert it under the left and right metal tabs as shown.

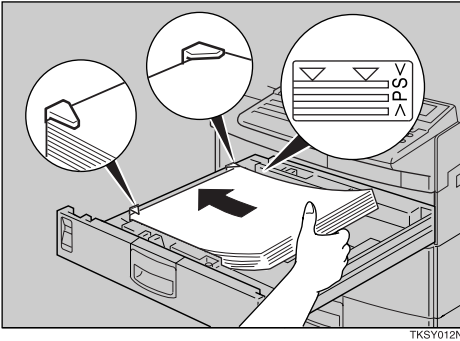

Important

- ❑ Do not load a stack of paper that exceeds the limit mark.

Limitation

- ❑ You can set up to 250 sheets in the main paper tray.

5 Gently return the paper tray to its original position.

Loading paper in the optional Paper Supply Unit

1 Pull out the paper unit.

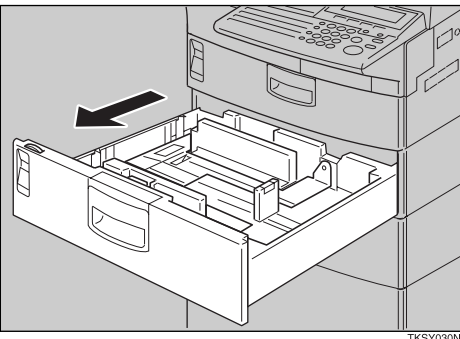

2 Rotate the dial until the loaded paper size is shown.

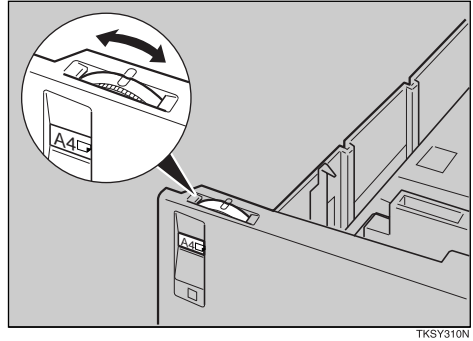

Important

- ❑ If the deal does not match the size of loaded paper, parts of printed images may be missing and paper jams could occur.

3 Prepare the new paper, then insert it under the left and right metal brackets as shown.

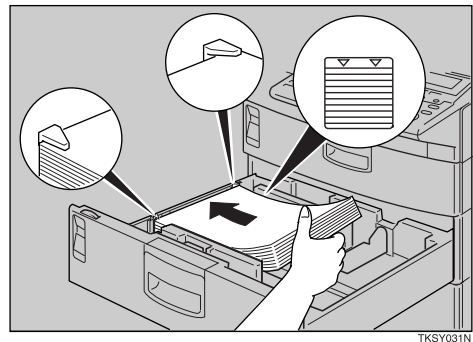

Important

- ❑ Do not load a stack of paper that exceeds the limit mark.

Limitation

- ❑ You can set up to 500 sheets in the paper unit.

4 Gently return the paper unit to its original position.

Adjusting Initial Settings

After you turn the machine on for the first time, you need to register the following settings:

- language
- Date and Time
- RTI and TTI
- Line type and CSI

Switching Language

If your native Language is Spanish or French, you can have the messages that appear on displays, lists and reports shown in either of these languages instead of in English. Follow the procedure below to change between the three languages.

Note

- Make sure that machine is in standby mode before following this procedure. If the standby display is not shown when you start, the display may become temporarily jumbled up.

- 1 Make sure that the machine is in standby mode.

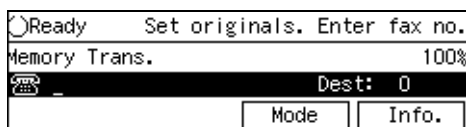

Note

- If the “Fax Features” or “Key Op. Tools” screen is shown, press the **[User Tools]** key. If any other display is shown, press the **[Clear Modes/Energy Saver]** key.

- 2 Press the **[User Tools]** key.

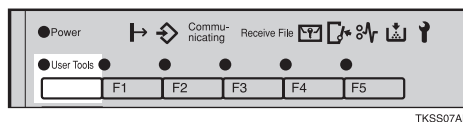

- 3 Press **[Language]**.

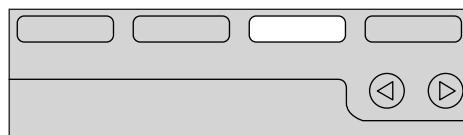
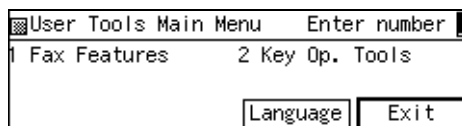

- 4 Press the **⏪** or **⏩** keys to select the language you require.

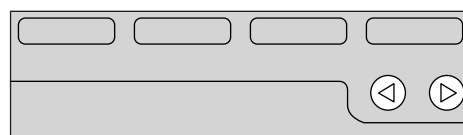

- 5 Press **[OK]**.

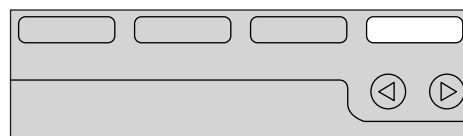

- 6 Press **[Exit]**.

Date/Time

Use this function to set your machine's internal clock to the current time and date. This time is shown on the display, printed on pages and used for various features, such as Send Later.

If the current date and time are wrong, use this procedure to correct them.

- 1 Make sure that the machine is in standby mode.

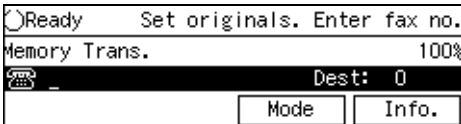

Note

- If the “Fax Features” or “Key Op. Tools” screen is shown, press the **[User Tools]** key. If any other display is shown, press the **[Clear Modes/Energy Saver]** key.

- 2 Press the **[User Tools]** key.

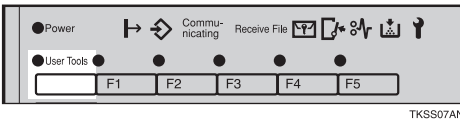

- 3 Enter the code for “Key Op. Tools” with the number keys. Then press the **[#]** key.

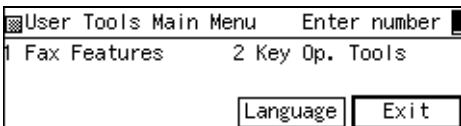

The “Key Op. Tools” main menu appears.

- 4 Enter the code for “System Settings” with the number keys.

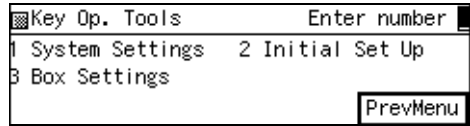

- 5 Enter the code for “Date/Time” using the number keys.

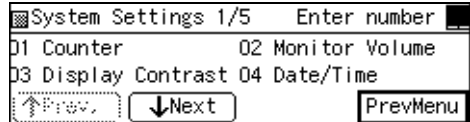

- 6 Select an item you want to change using the **[Left]** and **[Right]** keys, enter the correct date or time using the number keys and enter the month using **[UpMonth]** or **[DownMonth]**. Then press **[OK]**.

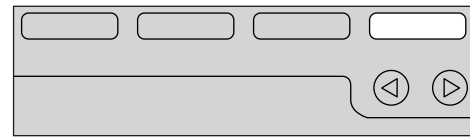
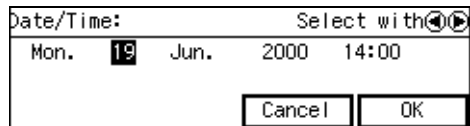

Note

- When you enter a date, the day is set automatically.
- Depending on your area, your machine will either except the date in 12 hours format or 24 hours format.

- 7 Press **[PrevMenu]** twice.

- 8 Press the **[Exit]** to return to the standby display.

Summer Time/DST

Whenever local custom requires advancing the clock or setting the clock back, use this feature. You can easily move the clock forwards when daylight saving time begins, and back when it ends.

Registering your RTI and TTI

The RTI (Receive Terminal Identification) is used to identify your machine to the other party when communicating with machines of the same make. The RTI can be up to 20 characters long and can contain letters, spaces, symbols and numbers.

The TTI (Transmitter Terminal Identification) is printed on the header of every fax you send and aids the other party identify your fax messages. The TTI can be up to 32 characters long and can contain letters, spaces, symbols and numbers.

Store something easily recognizable as the RTI and TTI, such as your name or company/department name.

Limitation

- ❑ The RTI will not be used unless the other party has a same make machine that supports the RTI feature.

- 1** Make sure that the machine is in standby mode.

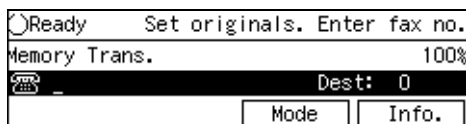

Note

- ❑ If the “Fax Features” or “Key Op. Tools” screen is shown, press the **[User Tools]** key. If any other display is shown, press the **[Clear Modes/Energy Saver]** key.

- 2** Press the **[User Tools]** key.

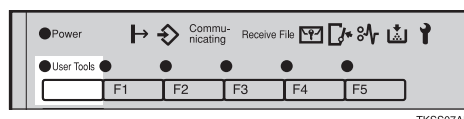

- 3** Enter the code for “Key Op. Tools” with the number keys. Then press the **[#]** key.

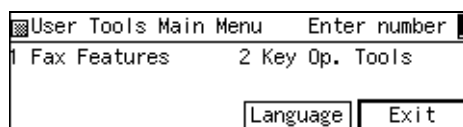

The “Fax Features” menu appears.

- 4** Enter the code for “System Settings” with the number keys.

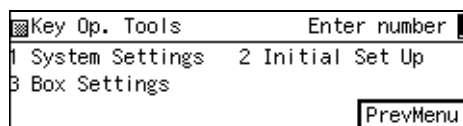

- 5** Enter the code for “RTI/TTI” using the number keys.

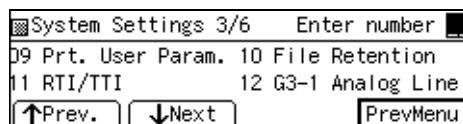

1

6 Press [RTI].

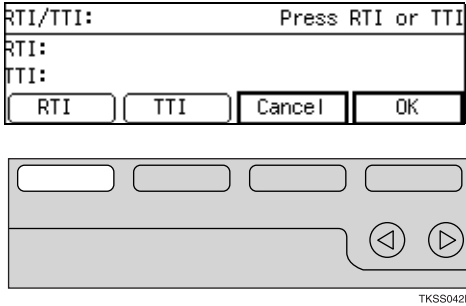

9 Enter your TTI and press [OK].

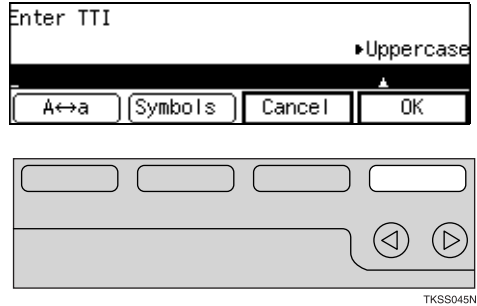

7 Enter an RTI and press [OK].

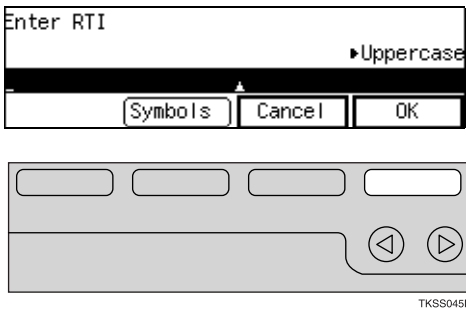

Reference
 P.307 "Entering and Modifying Text"

Reference
 P.307 "Entering and Modifying Text"

8 Press [TTI].

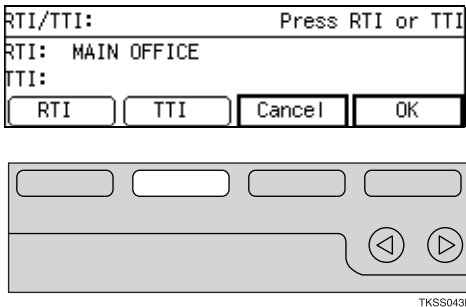

10 Press [OK] to confirm.

Note
 If you press [Cancel], the entered characters are canceled and the display shown in 5 appears again.

11 Press [PrevMenu] twice.

12 Press [Exit] to return to the stand-by display.

Selecting the line type and registering your CSI

You need to register the following items before you connect the machine to a G3 analog line:

- CSI (up to 20 digits)

The CSI (Called Station Identification) is passed to the other party when you send or receive a fax. When the CSI is received, it is shown on the display or printed on reports on the receiver's or sender's machine. The CSI works even if the receiver or sender uses a different make machine. The CSI can be up to 20 characters long and contain a plus sign (+), numbers and spaces. Register your country code, area code (minus the leading zero) and your fax number in that order.

- **PSTN Line Type**
Select whether the connected line uses tone or pulse dialing.
- **PSTN Access Number**
Use this setting to save having to enter a pause after the PSTN Access Number when dialing. For example, if you register "0" as the PSTN Access Number, a pause will be inserted automatically after the "0" when dialing.

Note

- The CSI feature is not available in some countries.

1 Make sure that the machine is in standby mode.

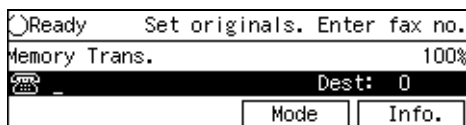

Note

- If the "Fax Features" or "Key Op. Tools" screen is shown, press the **[User Tools]** key. If any other display is shown, press the **[Clear Modes/Energy Saver]** key.

2 Press the **[User Tools]** key.

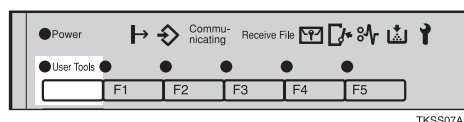

3 Enter the code for "Key Op. Tools" with the number keys. Then press the **[#]** key.

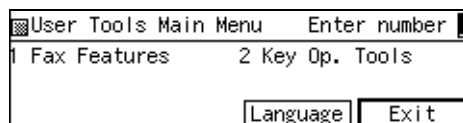

The "Fax Features" menu appears.

4 Enter the code for "System Settings" with the number keys.

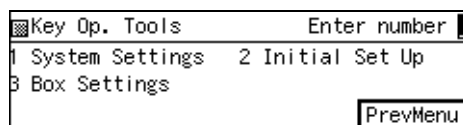

5 Enter the code for "G3-1 Analog Line" using the number keys.

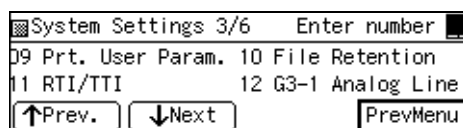

6 Enter the code for "PSTN Line Type" using the number keys.

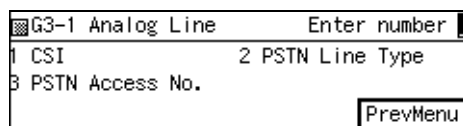

1

7 Select your line type using the **⏪** and **⏩** keys then press **[OK]**.

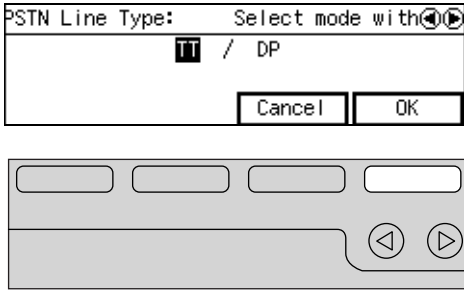

TKSS045N

11 Press **[Exit]** to return to the stand-by display.

8 Enter the code for "CSI" using the number keys.

9 Enter your CSI then press **[OK]**.

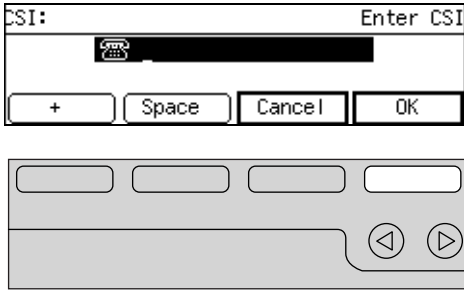

TKSS045N

Registering a PSTN Access Number

1 Enter the code for "PSTN Access No." with the number keys.

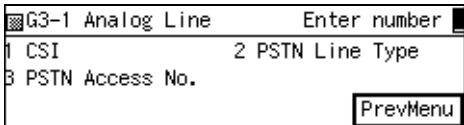

2 Enter PSTN Access Number with the number key, then press **[OK]**.

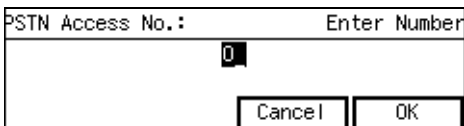

10 Press **[PrevMenu]** three times.

Handy Functions

1

Energy Saver Mode

Energy Saver mode is a power saving feature.

When not used for 5 minutes, the machine reduces its electricity consumption to the bare minimum.

- There are two kinds of Energy Saver mode, and you can choose which takes priority:
 - Fax Standby Use if you frequently receive incoming faxes
 - Low Power Standby Use to minimize power consumption

Energy Saver Mode	Machine Status	Warm-up Time To Be Ready To Print	High Temperature Standby Mode ^{*1}	Power Consumption ^{*2}
Low Power Standby	Display is blank, power to heater is off	Within about 55 seconds	You can switch this on or off	2.0W ^{*3}
Fax Standby	Display is blank, power to heater is low	Within about 45 seconds	You can switch this on or off	45W

^{*1} It is possible to combine High Temperature Standby mode with either Low Power Standby mode or Fax Standby mode. If you turn High Temperature Standby on, 15 minutes after entering Energy Saver mode the heater power is not turned off.

^{*2} Values for when no options are installed.

^{*3} 2.1W when the optional G4 unit is installed, 2.7W when the optional G3 unit is installed, 7.1W when the optional NIC FAX Kit is installed, 8.5W or 13W (with NIC FAX Kit) when the optional printer interface is installed.

- Documents already stored in memory will still be sent, and fax reception is still possible. When a fax is received, the machine prints it out then returns to Energy Saver mode.
- In Energy Saver mode, the operation panel display goes blank. However, if a message is received using Substitute Reception or Confidential Reception, an indicator will light to inform you. If the Substitute Reception indicator or Confidential Reception indicator is lit or flashing, exit Energy Saver mode and take appropriate action.

⚠ Limitation

- ☐ The machine switches to Low Power Standby mode as long as the following apply:
 - Low Power Standby mode is turned on
 - The machine is not being used

- The heater temperature is low
- Remaining memory is 100%
- No documents are awaiting transmission
- Substitute Reception is turned on
- The optional PC-FAX Expander are not installed
- No error message is displayed
- No document is set in the ADF
- No document is set in the bypass tray

 **Note**

- When the machine is shipped, Low Power Standby is selected as the default Energy Saver mode. You can change this with the User Parameters. ⇒ P.250 “*Changing the User Parameters*”
- When the machine is shipped, High Temperature Standby Mode is turned off by default. You can turn High Temperature Standby Mode on or off with the User Parameters.

 **Reference**

Another power saving feature, Night Timer, is also available. ⇒ P.248 “*Night Timer*”.

Use this feature to have the machine automatically enter and exit Low Power Standby mode at certain times of the day. Documents received in Low Power Standby mode are stored in memory and printed when the Night Timer "on" time is reached. To exit this mode manually, just press the **[Clear Modes/Energy Saver]** key. Any received documents will be printed, and if the machine is not used for about 5 minutes, the heater will be turned back off.

Entering Energy Saver Mode

The machine will enter this mode under two situations:

- When the machine is not used for a certain period of time

 **Note**

- When the machine is shipped, this period is set to 5 minutes. If you wish to change the period, please contact your service representative.
- When the **[Clear Modes/Energy Saver]** key is pushed down for about 2 seconds.

Exiting Energy Saver Mode

There are three ways to exit this mode:

- Press the **[Clear Modes/Energy Saver]** key.
- Set a document.
- If you have an external telephone handset installed, lift the handset.

Adjusting the Printing Density

You can economize on toner by adjusting the image density used when generating all printed output (Output Density), or for just incoming faxes, reports and lists (Toner Saving).

Output density

This setting specifies the image density used for printing incoming faxes, reports, lists and copies.

Three levels are available: Dark, Normal, Light.

Note

- When the machine is shipped, the default setting is Normal. You can change this with the User Parameters. ⇒ P.250 *“Changing the User Parameters”*

Toner saving

Use this feature to save on over 50% of the toner used for printing incoming faxes, reports and lists.

Limitation

- This feature does not apply to copies, or prints made with the printer option. However, the optional Printer Interface has its own toner saving function.
- If this feature is turned on, it invalidates the Output Density feature and image density is fixed at Normal.

Note

- When Toner Saving is turned on, printed images will come out lighter than usual. To check on the image quality, print out the User Parameter List. ⇒ P.257 *“Printing the User Parameter List”*
- If the other party sends you a fax using the Photo (Halftone) setting, the printed fax image may differ from the document image.
- When receiving faxes sent using Photo (Halftone) mode from this maker's machines, turn Toner Saving off.
- When the machine is shipped, Toner Saving is turned off by default. You can turn Toner Saving on or off with the User Parameters. ⇒ P.250 *“Changing the User Parameters”*

Boxes

The following functions are for delivery and transfer of messages:

- Personal Box
- Information Box
- Transfer Box

By using SUB and SEP codes with these functions, you can send messages to another party's box and retrieve messages stored in boxes.

For how to set up these functions, see P.304 *“Box Settings”*.

For how to print out and delete messages stored in boxes, see P.169 *“Box File Manager Functions”*.

Note

- ❑ The combined total of items that can be stored with the Personal Box, Information Box and Transfer Box features is 150. Installing the optional Function Upgrade Card increases this capacity to 400 items.
- ❑ SUB and SEP codes can be up to 20 digits long and contain digits, spaces, pound signs (#), and asterisks (*).

Personal Boxes

This feature lets you set up the machine so that incoming messages addressed to certain users are stored in memory instead of being printed out immediately. Each user must be assigned a SUB Code (Personal Code) that has been designated as a Personal Box beforehand. When the other party sends their message, they specify the SUB code of the user they are sending to. When the message is received, it is stored in the Personal Box with the matching SUB Code. In order to print a message received into a Personal Box, you must enter the SUB

code assigned to that Personal Box. This enables several individuals or departments to share a single fax machine yet be able to differentiate between messages. Furthermore, if you specify a receiver for the Personal Box, instead of being stored in memory, incoming messages with this SUB code appended are forwarded directly to the destination you specify.

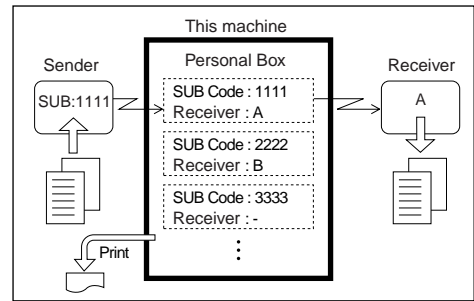
**Note**

- ❑ To be able to receive messages into a Personal Box, you must inform the sender of the SUB code registered for that Personal Box, and ask them to send the message using SUB Code Transmission with that SUB code.
- ❑ When messages have been received into Personal Boxes, the Confidential Reception/Memory Lock indicator lights and the Confidential File Report is printed.
- ❑ If a Personal Box is assigned a receiver, incoming messages are transferred to that receiver with a forwarding mark(⇒ P.285) stamped on them. If a receiver is not assigned, see *Printing Personal Box Messages on P.169 "Printing Personal Box Messages"* for how to print these messages out.

Information Boxes

Use the Information Box feature to set up the machine as a fax information service or document server. By scanning documents into Information Boxes, other parties can receive these messages whenever they request them.

To check on the contents of Information Boxes, use the Print Information File function .

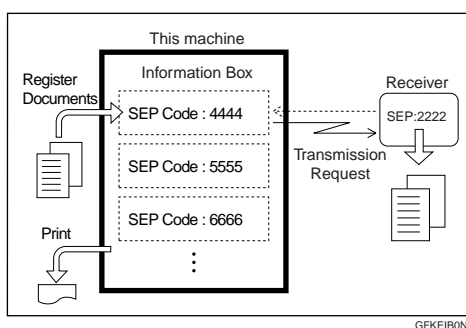

Note

- ❑ Register documents for this feature using the “*Storing Messages in Information Boxes*” ⇒ P.170.
- ❑ For other another party to be able to retrieve a message registered in an Information Box, you need to inform them of the SEP code assigned to that Information Box.
- ❑ When a SEP Code Polling Reception request is made by another party, the SEP code they specify is compared with the SEP code registered in that Information Box. If the codes match, the message stored in the Information Box is sent to the other party automatically.
- ❑ To check on the contents of Information Boxes, use the “*Printing Information Box Messages*” ⇒ P.171

Transfer Boxes

This feature turns your machine into a fax relay station. Documents sent with a SUB Code that matches the SUB Code registered as a Transfer Box are received then relayed to the registered receiver.

Since documents can be sent to multiple destinations in a single transfer request, you can economize on communication costs when sending to remote destinations.

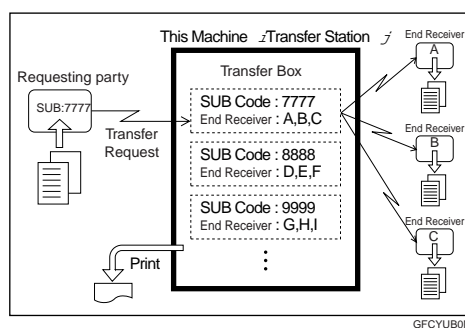

Note

- ❑ Inform the requesting party of the SUB code assigned to the Transfer Box. When they wish to have a message transferred by your machine, ask them to send the message using SUB Code Transmission and specifying this SUB code. If a password is also registered, inform of this too and ask them to enter it for the SID code.

Forwarding E-mail by using Dial in number or Sub-address

This feature requires the optional G4 Unit and the optional NIC FAX Kit.

By using the Boxes function, you can receive messages to the Dial in number or Sub-address, and also can automatically forward these messages to the e-mail address you preset before.

Preparation

Before you use G4 Digital Line, it requires some settings as follows:

- Specify the Own Fax Number 1 for the G4 Digital Line
- Register the Personal Box or Transfer Box for Dial in number or Sub-address
- Set the forwarding mail address to the Receiver

Limitation

- If you set a password for the Transfer Box, you can not receive the message.
- If you set the Personal Box or Transfer Box for the Dial in number, the Dial in number can not receive the document with some functions as follows:
 - Confidential Transmission
 - Transfer Request
 - Remote Transfer

Note

- If you set the Personal Box or Transfer Box for the Dial in Number, you can send a message to the Dial in Number but the Sub-address will be ignored.
- If you want to forward the document from your phone number (1112223000) to another phone number (1112223001), then you need to preset the forwarding number to either the Personal Box or Transfer Box. If you select the Transfer Box, the sub code setting requires the phone number without the area code (2223001).

- If you want to forward the e-mail depending on the Sub-address, the Personal Box or Transfer Box requires you to set the Sub Code with Sub-address (up to 19 digits).
- For how to specify the e-mail address, please refer to the optional NIC Fax Kit manual.

Reference

P.42 "Personal Boxes"

P.43 "Transfer Boxes"

P.87 "Sub-address"

Restricted Access

Use this feature to restrict access to the machine or monitor machine usage by user or department. When turned on, users must enter a previously assigned code before they can use the machine.

Preparation

In order to use this feature you need to register Personal Codes (Personal Box SUB Codes) beforehand.⇒ P.304 "Registering/Editing Personal Boxes"

Note

- When the machine is shipped, this feature is turned off by default. Turn it on or off with the User Parameters.⇒ P.250 "Changing the User Parameters"
- The machine returns to the state where a Personal Code must be entered to use the machine in the following situations:
 - The machine is not used for a certain time
 - A previously set document is removed

- The current operation is completed
- You can control at what times of the day Restricted Access is turned on by linking it to the Night Timer feature with the User Parameters (⇒ P.250). If you do this, Restricted Access is turned on at the Night Timer "on" time, and turned off at the Night Timer "off" time.
- When Restricted Access is turned on, incoming faxes are received and printed as normal.
- User names printed on all reports are those used by the Personal Box feature.

1 Check that the Restricted Access display is shown.

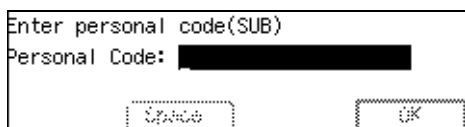

2 Enter your user code with the number keys.

3 Press [OK].

Note

- If the code you entered does not match any of the Personal Box SUB codes, a warning message is displayed and the screen in step 1 reappears.
- When Restricted Access is turned on and you enter a user code to use the machine, Personal Code Transmission is selected by default.

TX/RX File Save Function

This feature requires the optional Fax Feature Expansion Card and optional 40M Expanded Memory Card.

When turned on, sent or received messages are automatically saved to memory. Once stored you can then check on previous communications and print them out as necessary.

Important

- If a TX/RX file is saved in memory, it does not guarantee that the communication was successful. Messages that were not delivered, or generated an error are also stored.

Limitation

- If any of following features are used, messages are not stored in memory:
 - Immediate Transmission
 - Confidential Transmission
 - Polling Transmission
 - Confidential Reception
 - Memory Lock Reception
 - Transfer Request Reception
 - Polling Reception
 - Auto Documents
 - Memory Forwarding
 - Optional Fax On Demand
- When free memory goes below 50%, the oldest stored message is erased.

Note

- When the machine is shipped, this feature is turned off by default. Turn it on or off with the User Parameters. ⇒ P.250 "Changing the User Parameters"
- By default, both transmissions and receptions are stored. Your service representative can change this to one of the following options:
 - Transmissions Only
 - Receptions Only

Multi-Port Unit (Option)

If you install the optional G3 unit, or optional G4 unit, two communications on separate lines can take place simultaneously.

Limitation

- ❑ Although a single ISDN line can handle two separate line communications, if you connect to ISDN via a PABX, only one line communication is possible.
- ❑ This machine does not support G4+G4 communication.
- ❑ The machine cannot use two lines for a single operation. For example, when broadcasting to multiple destinations in a single operation, you cannot send to one destination at the same time as sending to another.
- ❑ Immediate Transmission cannot take place simultaneously with another communication.
- ❑ It is not possible print a received document when two simultaneous communications are taking place.
- ❑ On-hook Dial only works with the main line that the machine is connected to. ⇒ P.73 "On-Hook Dial"

Note

- ❑ The standard machine supports a single PSTN line connection.
- ❑ The optional G3 unit supports a single extra PSTN line.
- ❑ Your service representative can set the optional G3 unit for reception only. Contact your service representative for details.
- ❑ The optional G4 unit supports a single ISDN line.

- ❑ The following table lists the various possible protocol permutations:

Machine Configuration	Connected Line Types	Possible Protocol Combinations
Base machine only	PSTN	G3
Base machine + optional G3 unit	PSTN + PSTN	G3 + G3
Base machine + optional G4 unit	PSTN + ISDN	G3 + G4
	ISDN	I-G3 + G4

- ❑ When multiple communications are taking place at the same time, the display shows the communication that started first.

Acceptable Types Of Documents

Set documents after all ink and correcting fluid has completely dried. If the document is not completely dry, the scanner glass will be marked causing black lines to appear on copies and sent faxes.

1

Acceptable Document Sizes

Where document is set	Acceptable document size	Maximum number of sheets	Paper thickness
Auto Document Feeder (ADF)	<ul style="list-style-type: none"> • Maximum size 304 × 600mm, 11.97" × 23.62" • Minimum size 148 × 105mm, 5.83" × 4.2" 	<ul style="list-style-type: none"> • A3: 30 • B4: 40 • A4: 75 	0.05 to 0.2mm(50-80g/m ² , 16-24 lb paper)
Bypass Tray	<ul style="list-style-type: none"> • Maximum size 304 × 1200mm, 11.97" × 47.24" • Minimum size 148 × 105mm, 5.83" × 4.13" 	1	0.05 to 0.3mm(50-120g/m ² , 16-36 lb paper)

Documents unsuitable for the Auto Document Feeder (ADF)

Do not set the following types of documents in the Auto Document Feeder (ADF) because they may be damaged.

- Documents of sizes other than those specified in the previous table
- Documents containing staples or clips
- Perforated or torn documents
- Curled, folded, or creased documents
- Pasted documents
- Documents with any kind of coating, such as art paper, aluminum foil, carbon paper, or conductive paper
- Documents with indexes, tags, or other projecting parts
- Documents of inappropriate weight (see table above)
- Documents with a smooth or shiny front surface
- Documents with pencil writing on the back

Note

- ❑ To avoid damage to important document or documents through mishaps, such as paper jams, we recommend that you set copies of such documents.

Documents unsuitable for the Document Bypass Tray

Setting any of the following types of document in the document bypass tray could cause a paper jam and/or damage to documents:

- Documents of sizes other than those specified in the previous table
- Perforated or torn documents
- Curled, folded, or creased documents
- Pasted documents
- Documents with any kind of coating , such as art paper, aluminum foil, carbon paper, or conductive paper
- Documents with indexes, tags, or other projecting parts
- Thin and soft documents
- Sticky documents such as translucent paper

Paper Size and Scanned Area

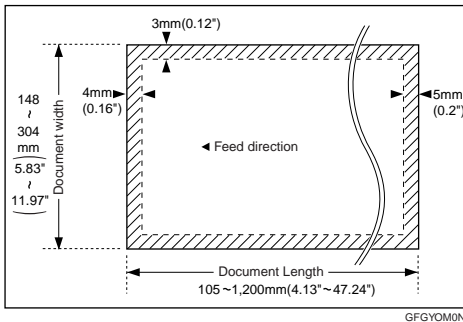

Note

- ❑ Even if the document is correctly in the Auto Document Feeder (ADF), the shaded areas shown in the above illustration can not be guaranteed to be scanned.
- ❑ If the receiver uses paper narrower than the document, the image will be reduced to fit the paper width. ⇒ P.97 "Auto Reduction"
- ❑ The machine detects paper sizes in the following ways.

- When you set a document in the Auto Document Feeder (ADF), a document narrower than about 230mm is scanned as A4 size wide. A document about 242–261mm is scanned as B4 size. A document wider than about 274mm is scanned as A3 size. You can scan in documents of up to 600 mm in length.



How to Set a Document

In this manual a document can mean a single or multiple page document. You can set your documents either in the Auto Document Feeder (ADF) or document bypass tray.

Direction in Which Original is Set

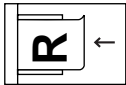

The direction in which you should set the document in the Auto Document Feeder (ADF) depends on the document size:

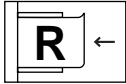
❖ How to set A4, B4, A3, and LT size documents

Original	Where Original is set
	
	

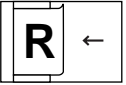

GFGSET0N

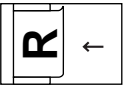
❖ How to set A5 size documents

Original	Direction in which to set document
	
	

GFGSET1N

Note

- When sending a fax, the image output at the other end depends on the size and direction of paper used in the receiver's terminal. If the receiver does not use paper of the same size and direction as that of the document, the fax image may be output reduced, trimmed at the both edges, or divided into two or more sheets. When sending an important document, we recommend you to ask the receiver about the size and direction of the paper used in their terminal.
- It is possible to set A4  and A4  documents as you would A5 or B5 documents, but there is no guarantee that they will be sent correctly.
- Make sure that all ink, correcting fluid etc., has completely dried before setting your document. If it is still wet, the scanner glass will be marked and those marks will appear on the received image.

Setting Documents in the Auto Document Feeder (ADF)

Use the Auto Document Feeder (ADF) to scan in a stack of documents in one operation.

Limitation

- You can scan in documents of up to 23.7" (600mm) in length.
- Place all the documents to be sent in a single stack.
- You cannot set documents in the Auto Document Feeder (ADF) one page at a time or in sheaves.

- ❑ Set documents with pencil writing on the back in the document bypass tray.
- ❑ Do not set a stack of documents containing pages of different width in the Auto Document Feeder (ADF).
- ❑ Do not open the Auto Document Feeder (ADF) while it is scanning the documents. Otherwise, document will be jammed.

Note

- ❑ Set documents more than 23.7" (600mm) long in the Document Bypass tray.
- ❑ If your document is bent or folded, flatten it before you set it.

Reference

For information about the sizes and number of documents that can be placed in the Auto Document Feeder (ADF), see P.47 "Acceptable Types Of Documents".

- 1** Adjust the document guide to match the size of your documents.
- 2** Align the edge of your documents and stack them in the Auto Document Feeder (ADF) face up.

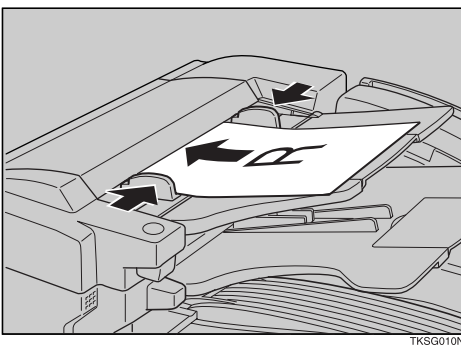

- 2** Adjust the document guides to match the width of your document. Then set your document with side you wish to send face-

Setting Paper in the Document Bypass Tray

Set your document in the document bypass tray if it falls under any of the following categories:

- It is longer than 23.62" (600mm)
- The front side is shiny or smooth
- The rear side is written in pencil

Limitation

- ❑ The machine can scan documents up to 47.24" (1,200mm) long.
- ❑ You can only set one page at a time in the document bypass tray.
- ❑ Do not set another document in the Auto Document Feeder (ADF) while a document is being scanned from the document bypass tray or a jam could occur.

- 1** Open the document bypass tray in the direction of the arrow.

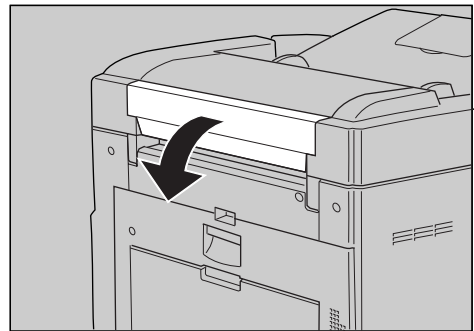

down.

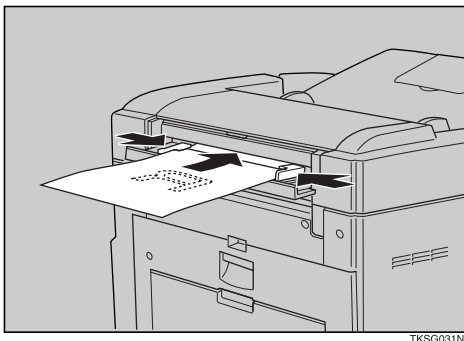

 **Note**

- Slowly insert the document into the document bypass feeder while it is automatically fed in.
- You can only set one page at a time in the document bypass tray.
- If your fax document or copy document is longer than 16.54" (420mm), support it with your hand.

Recommended Paper

We recommended you use this supplier's paper only.

1

Acceptable Copy Paper Sizes and Types

Location	Acceptable Sizes	Maximum Number of Sheets
Main Paper Tray	A3 ☐, B4 ☐, A4 ☐☐, A5 ☐☐, F ☐, F4 ☐, LT ☐	250
Optional Paper Supply Unit	As above	500

Important

- ☐ Take the following precautions when storing paper:
 - Keep paper away from direct sunlight
 - Keep paper in a dry environment (less than 70% humidity)
 - Store on a flat surface
 - Keep unpacked paper in a vinyl bag to avoid absorption of moisture

Unacceptable Paper Types

To avoid paper jams, do not load the following kinds of paper:

- Curled, folded, or creased paper
- Torn paper
- Perforated paper
- Rough paper
- Thin and soft documents
- Smooth or shiny paper

Note

- ☐ If you use rough grained paper, printed output may not be clear.

Changing the Paper Size

1

This section explains how to change the size of paper set in the main paper tray and the optional paper supply unit.

Reference

For acceptable paper types, directions, sizes and capacity, see P.53 "Recommended Paper".

Changing the Paper Size in the Main Paper Tray

1 Pull the paper tray fully out until it stops, then lift it out with both hands.

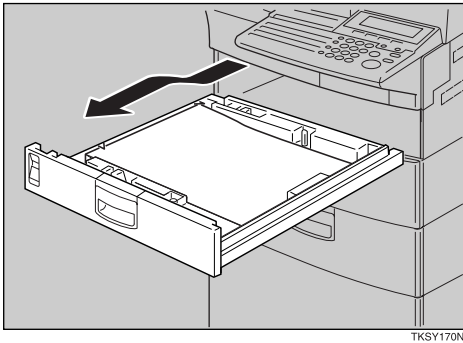

2 Push down on the paper until the base plate clicks.

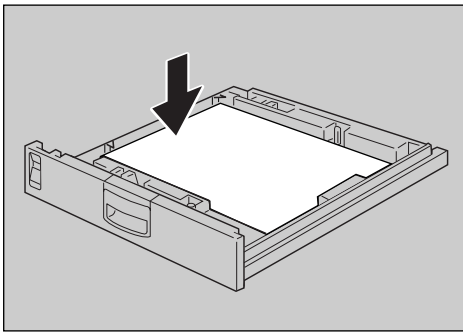

5 While holding in the green release lever, adjust the front fence

3 Remove the paper.

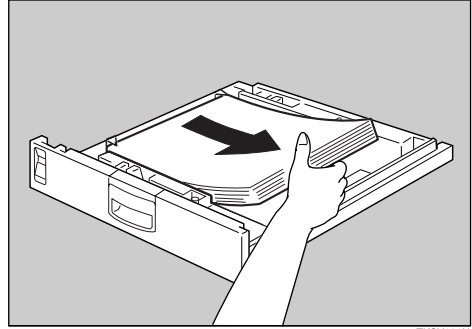

4 Adjust the dial to match the paper size.

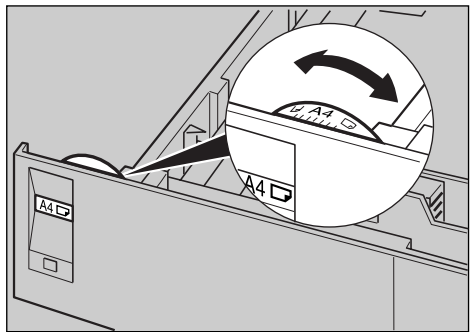

Important

If the dial does not match the size and direction of loaded paper, parts of printed images may be missing and paper jams could occur.

to match the new paper size.

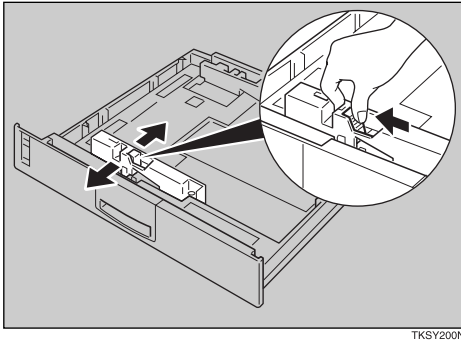

TKSY200N

Note

□ The front fence might be fixed by screw.

6 Make sure that the front fence is aligned with the size line on the base of the paper tray.

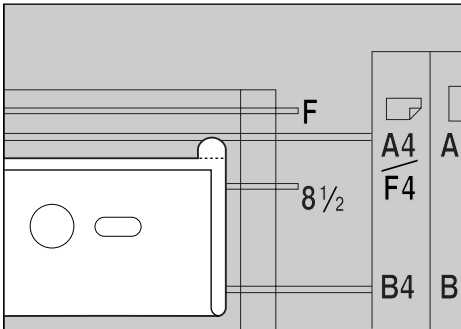

TKSY210N

7 Remove the two green screws on the rear fence as shown.

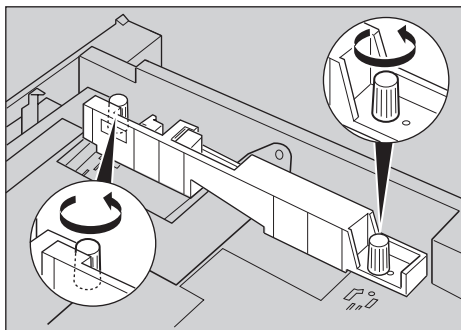

TKSY220N

8 While holding in the green release lever, align the rear fence to the new paper size.

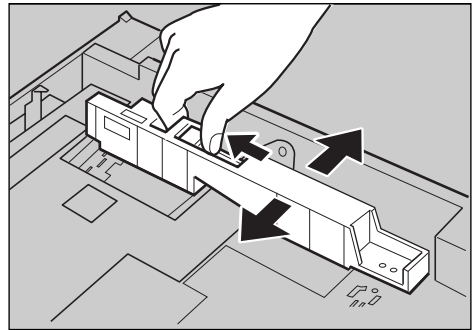

TKSY230N

9 Check that the rear fence is set in the correct position.

Make sure that the holes in the base of the paper tray are properly aligned with the holes in the rear fence.

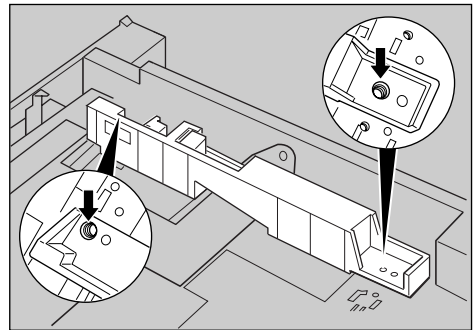

TKSY240N

10 Fix the rear fence with the two screws you removed in step 7.

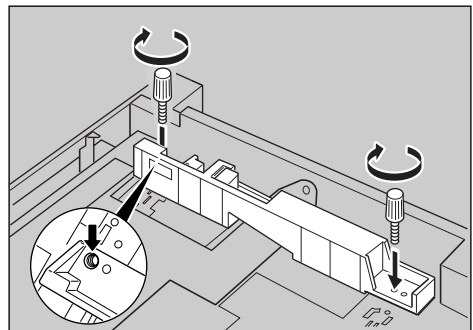

TKSY250N

11 While squeezing in the sides of the side fence, lift it out.

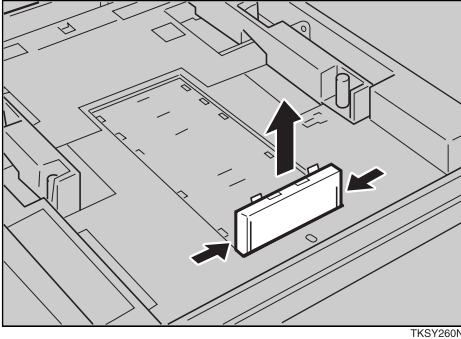

12 Replace the side fence so that it matches the new paper size.

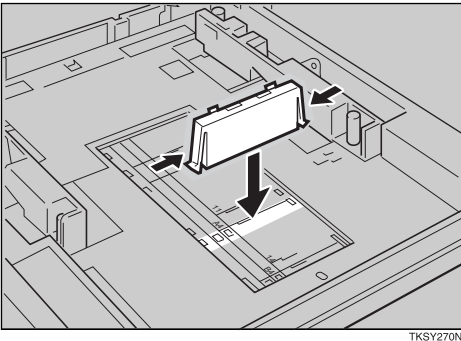

Important

Make sure the tags at the bottom of the side fence are properly inserted.

13 Prepare the new paper, then insert it under the left and right metal tabs as shown.

Fan the paper stack and insert it with the side you wish to point onto face-up.

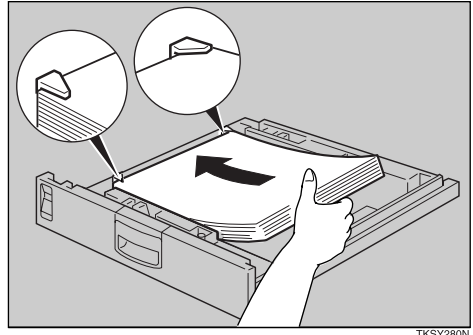

Important

Do not load a stack of paper that exceeds the limit mark.

Limitation

You can set up to 250 sheets in the main paper tray.

14 Gently return the paper tray to its original position.

Changing the Paper Size in the Optional Paper Supply Unit

1 Pull the paper unit fully out until it stops, then lift it out with both hands.

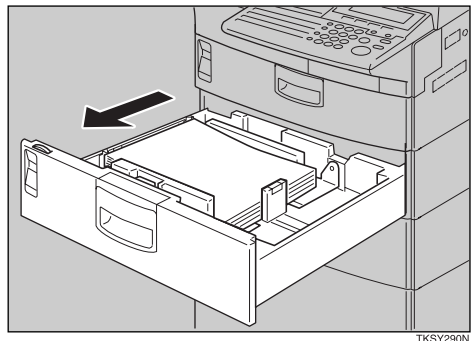

2 Remove the paper.

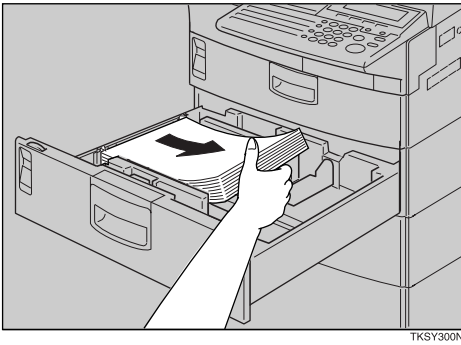

3 Adjust the dial to match the paper size.

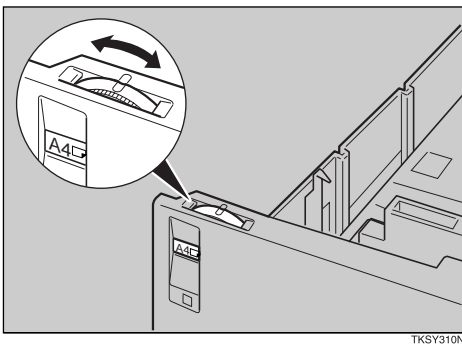

Important

- If the dial does not match the size of loaded paper, parts of printed images may be missing and paper jams could occur.

4 While holding in the green release lever, adjust the front fence to match the new paper size.

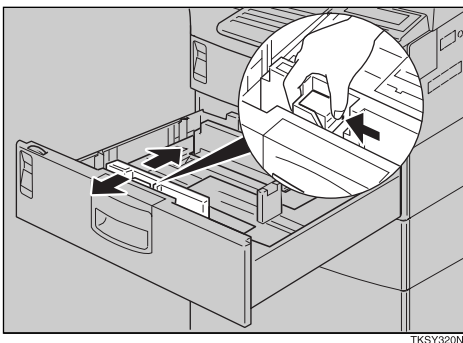

Note

- The front fence might be fixed by screw.

5 While squeezing in the sides of the side fence, lift it out.

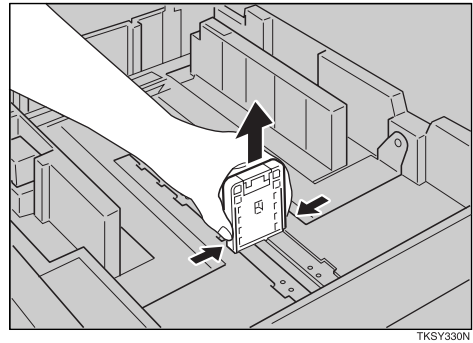

6 Replace the side fence so that it matches the new paper size.

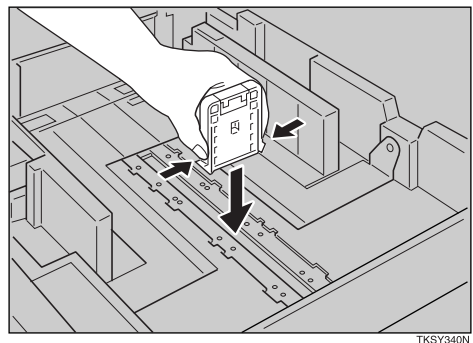

Important

- Make sure the tags at the bottom of the side fence are properly inserted.

7 Prepare the new paper, then insert it under the left and right metal tabs as shown.

Fan the paper stack and insert it with the side you wish to print onto face-up.

1

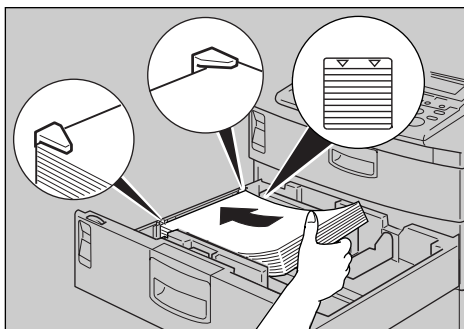

TKSY350N

⚠ Important

- Do not load a stack of paper that exceeds the limit mark.

💡 Limitation

- You can set up to 500 sheets in the paper unit.

- 8** Gently return the paper supply unit to its original position.

2. Sending a Fax Message

Overview

Overview

The basic procedure to send a fax message is:

- ① Set your document.
- ② Dial the number.
- ③ Press the **[Start]** key.

The rest of this section describes these steps and the various features that are available in more detail.

There are two ways to send a fax message:

- Memory Transmission
- Immediate Transmission

Check the indicators on the operation panel to check which mode is currently active and press the **[Transmission Mode]** key to toggle between them.

Memory Transmission

In Memory Transmission mode, after you press the **[Start]** key, the machine doesn't dial the destination until all pages of your fax message have scanned into memory (in contrast with Immediate Transmission, where the number is dialed first and pages are scanned and sent one by one).

Memory Transmission is useful because:

- You can take your document away from the machine without having to wait too long
- While your message is being sent, other people can use the machine
- You can send the same message to more than one destination in a single operation. This technique is referred to as Broadcasting.

Important

- ❑ If there is a power failure, the power switch is turned off, or the plug is pulled out for more than 1 hour, all files stored in memory are deleted. As soon as power is restored, the Power Failure Report is printed to help you identify deleted files. ⇒ P.192 *"When Power is Turned Off or Fails"*

Limitation

- ❑ If memory is full (0% appears on the display), Memory Transmission is disabled. In this case use Immediate Transmission instead.

Note

- ❑ Maximum number of Memory Transmission files: 250 (1,000 when the optional Function Upgrade Card is installed)

- ❑ Maximum number of destinations per Memory Transmission: 250
- ❑ Combined total number of destinations that can be stored: 500 (2,000 when the optional Function Upgrade Card is installed)
- ❑ The number of pages that you can store in memory depends on the original document images and the scan settings. You can store up to 160 standard pages (ITU-T No.1 chart, Resolution: Standard, photo mode: off).
- ❑ As default, the machine will return to the default transmission mode (Memory Transmission) after every transmission. You can change this so that the current mode is maintained. ⇒ P.250 *"Changing the User Parameters"*
- ❑ You can expand the amount of memory available for storing documents by installing either of the following options:
 - 2M Expanded Memory Card: Up to about 320 pages.
 - 4M Expanded Memory Card: Up to about 480 pages.
 - 40M Expanded Memory Card: Up to about 1,200 pages.
 - 40M Expanded Memory Card and Function Upgrade Card: Up to about 3,000 pages.
- ❑ The maximum number of fax numbers you can dial with the number keys when sending a fax to multiple destinations depends on the machine configuration:
 - 100 on standard models
 - 1,000 when the optional Function Upgrade Card is installed

1 Make sure that the Memory Transmission indicator is lit.

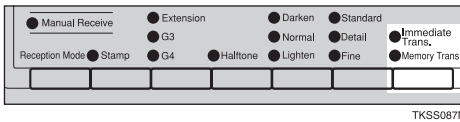

If it is not lit, press the **[Transmission Mode]** key.

2 Set your document.

Note

- The document can be placed at any time up until you press the **[Start]** key.

Reference

P.50 "How to Set a Document"

3 Select any scan settings you require.

Reference

P.76 "Scan Settings"

4 Dial the destination number. If you wish to send the same message to more than one destination, press **[Add]** and dial another destination. Repeat this step for all destinations.

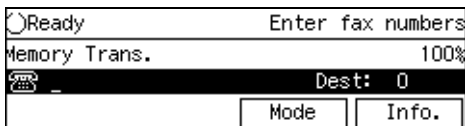

Note

- If you make a mistake, press the **[Clear]** key or **[Stop]** key and try again. The **[Clear]** key deletes one character at a time, and the **[Stop]** key deletes the whole line.

- When dialing with the number keys or using Chain Dial(⇒ P.87), you can select the line type (G3 or G4) before pressing **[Add]** in step 4.

- If you do not set a document within 1 minute of entering a destination fax number, the transmission is canceled.

- If the "No Documents, No Dial" function is turned on, you cannot dial before setting your document.⇒ P.96 "No Document, No Dial"

Reference

P.81 "Dialing"

P.79 "Selecting the Line"

5 Press the **[Start]** key.

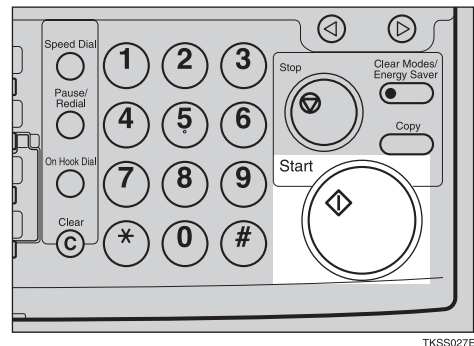

The machine starts scanning the document.

The machine connects to the destination. The name or fax number which is programmed as the RTI or CSI in the other party's fax machine is shown on the display.

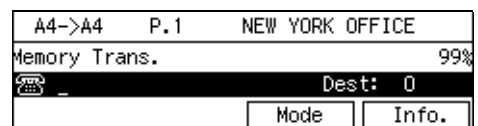

Reference

P.35 "Registering your RTI and TTI"

After transmission the machine will return to standby mode.

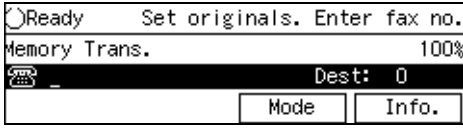

2

❖ **Checking the transmission result**

Turn on the Communication Result Report if you want a report to be printed after every successful transmission.⇒ P.65 *“Communication Result Report (Memory Transmission)”*

If you leave the Communication Result Report off, the report will not be printed after every transmission. However, should a transmission fail, a Communication Failure Report will be printed instead.

If you turn the Communication Result Report off, the Communication Failure Report will be printed when a communication fails.

You can also check the transmission result by examining the Journal.⇒ P.156 *“Printing the Journal”*

You can print the Journal or view it on the display panel.⇒ P.150 *“Checking the Transmission Result (TX Status)”*

❖ **Sending a fax straight away**

When you wish to send a fax straight away, use Immediate transmission. If a Memory Transmission is in progress, the display will switch to transmission standby and as soon as the current transmission has finished, the Immediate Transmission will start automatically.⇒ P.69 *“Immediate Transmission”*

If already sending to more than one destination with Memory Transmission and your document has already been scanned in, Broadcasting is interrupted to allow the Immediate Transmission to be sent.

However, if a transmission other than the current transmission is on standby, that document is sent first causing your Immediate Transmission to take a little longer.

❖ **Auto Redial**

If a fax message could not be transmitted because the line was busy or an error occurred during transmission, redialing is done 4 times at 5 minutes intervals (these figures vary according to which country you are in).

If redialing fails after four redials, the machine cancels the transmission and prints the Communication Result Report or Communication Failure Report.⇒ P.65 *“Communication Result Report (Memory Transmission)”*, P.65 *“Communication Failure Report”*

❖ **Broadcasting Sequence**

If you dial several destinations for the same message (Broadcasting) the messages are sent in the order in which they were dialed. If the fax message could not be transmitted, the machine redials that destination after the last destination specified for Broadcasting. For example, if you specify four destinations A through D for broadcasting, and if the lines to destinations A and C are busy, the machine dials the destinations in the following order: A, B, C, D, A, and C.

❖ Broadcasting: Checking Progress

To check which destinations the fax message has been sent to so far, print the TX file list.⇒ P.149 *"Printing a List of Files in Memory (Print TX File List)"*

❖ If memory runs out while storing a document

If you run out of memory while storing a document (free space reaches 0%), the following display will appear:

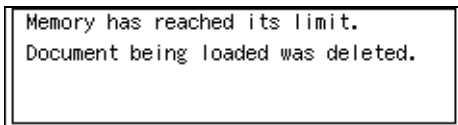

❖ When there is a document jam

① Check the message on the display then press **[OK]**.

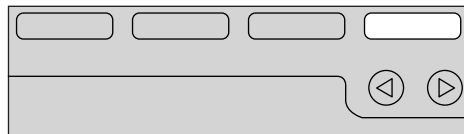
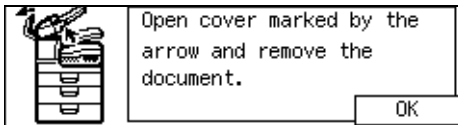

TKSS045N

② Remove the document.

🔍 Reference

P.180 *"Clearing Document Jams"*.

❖ Batch Transmission

If you send a fax message by Memory Transmission and there is another fax message waiting in memory to be sent to the same destination, that message is sent along with your document. Several fax messages can be sent with a single call, thus eliminating the need for several separate calls. This helps save communication costs and reduce transmission time.

Fax messages for which the transmission time has been set in advance are sent by Batch Transmission when that time is reached.

📌 Note

- By default Batch Transmission is switched on. You can switch it on or off with the User Parameters.⇒ P.250 *"Changing the User Parameters"*
- If you store the Batch Transmission function in a User Function key (**[F1]** to **[F5]**), you can turn it on or off by just pressing that key. The User Function key indicator will light when Batch Transmission is turned on.

❖ Dual Access

The machine can scan other messages into memory even while sending a fax message from memory, receiving a message into memory, or automatically printing a report.

Since the machine starts sending the second message immediately after the current transmission terminates, the line will be used efficiently.

Note that during Immediate Transmission, when copying, or when the User Tools menu is open, the machine cannot scan in documents.

❖ ECM (Error Correction Mode)

This feature automatically resends data that wasn't transmitted successfully using a system that complies with international standards. ECM requires that the destination machine has the same feature.

❖ Parallel Memory Transmission

With Parallel Memory Transmission the machine dials the destination while the document is being scanned in. Standard Memory Transmission stores the document in memory, then dials the destination. Parallel Memory Transmission allows you to quickly determine whether a connection was made. In addition, this function scans the document faster than Immediate Transmission and is useful when you are in a hurry and need to use the document for another purpose.

Note

- By default this feature is turned on. You can change this with the User Parameters.⇒ P.250 *"Changing the User Parameters"*

Limitation

- Standard Memory Transmission is used instead of Parallel Memory Transmission in the following cases:
 - When the line is busy and could not be connected to
 - With Send Later
 - With Transfer Request
 - With Duplex Original

- When you store a document for Memory Transmission while another communication is in progress
- When two or more destinations are specified
- When you send just an Auto Document
- With Image Rotation

- If you press the **[Stop]** key, the document jams, or memory becomes full during Parallel Memory Transmission, the machine stops transmitting and prints the Communication Result Report (Memory Transmission). The file is erased.
- Total stored page numbers are not printed with Parallel Memory Transmission. Only the page numbers are printed, such as P.1, P.2 not ¹/₂, ²/₂

Note

- If you run out of memory, normal Memory Transmission takes place. When and if this happens varies depending on the various options you have installed.

File Reserve Report (Memory Transmission)

This report is printed after a document is stored in memory. It helps you review the contents and registered destinations of documents stored for transmission. Even if the machine is set up not to print this report, it is still printed if a document could not be stored.

Limitation

- This report is not printed for messages sent using Parallel Memory Transmission.

Note

- You can turn this report on and off. By default it is not printed. ⇒ P.250 *“Changing the User Parameters”*
- You can choose whether to include part of the document image on the report (part of the image is printed by default). ⇒ P.250 *“Changing the User Parameters”*

Communication Result Report (Memory Transmission)

This report is printed when a Memory Transmission is completed so you can check the result of the transmission. If two or more destinations are specified, this report is printed after the fax message has been sent to all the destinations. If the machine is set up not to print this report and the fax message could not be successfully transmitted, the Communication Failure Report is printed. ⇒ P.65 *“Communication Failure Report”*

Note

- By default this function is turned on so you need to turn it off. ⇒ P.250 *“Changing the User Parameters”*
- You can choose whether to include part of the document image on the report (by default, part of the image is printed). ⇒ P.250 *“Changing the User Parameters”*

Communication Failure Report

This report is only printed if the Communication Result Report is turned off and a message could not be successfully transmitted with Memory Transmission. Use it to keep a record of failed transmissions so you can send them again.

Note

- You can choose whether to include part of the document image on the report (by default, part of the image is printed). ⇒ P.250 *“Changing the User Parameters”*

Canceling a Memory Transmission

Mission Before the Document is Scanned in

2

Perform this step if you have not pressed the **[Start]** key yet.

1 Press the **[Stop]** key.

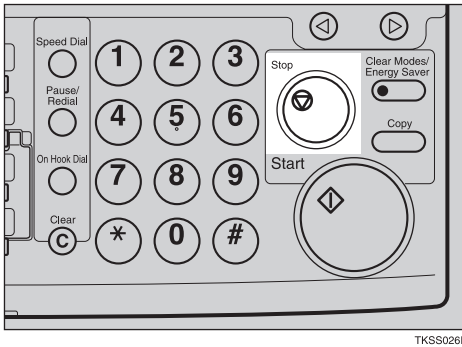

Note

- When your document is set in the ADF, you can also cancel Memory Transmission by removing it.

Canceling a Transmission while the Document is Being Scanned in

Perform this step if you have already pressed the **[Start]** key.

1 Press the **[Stop]** key.

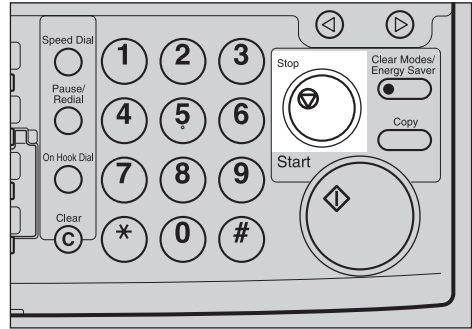

The machine will stop storing the document and the data will not be sent.

2 Check the message on the display.

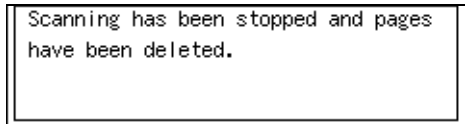

When there is a document jam

1 Check the message on the display then press **[OK]**.

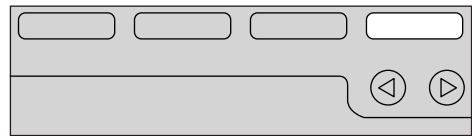
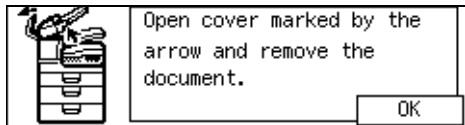

2 Remove the document.

Reference

P.180 "Clearing Document Jams".

Canceling a Transmission while the Machine is Dialing

Perform these steps if scanning has finished and the machine is dialing the destination.

- 1 Press the **[Stop]** key.

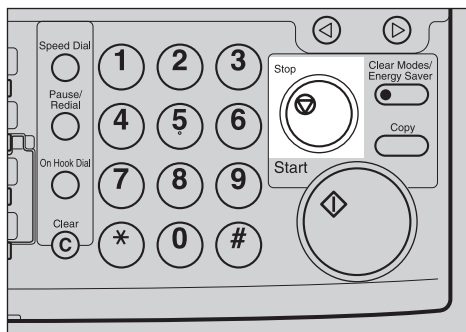

TKSS026E

- 2 Press **[Yes]**.

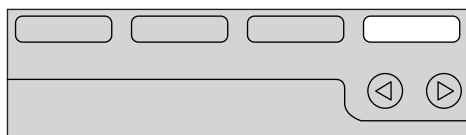
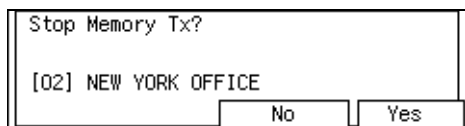

TKSS045N

Canceling a Transmission while the Message is Being Sent

Perform these steps if scanning has finished and the machine is sending the message.

Limitation

- ❑ If a transmission finishes while you are carrying out this procedure, it will not be canceled.

Note

- ❑ If you cancel a file while it is being sent, transmission is halted as soon as you finish this procedure. However, some pages of your message may have already been sent and will still be received at the other end.

- 1 Press **[Info.]**.

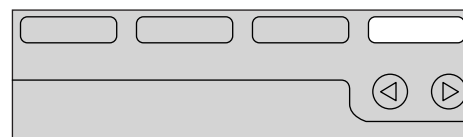
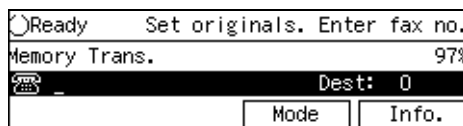

TKSS045N

The "Information" menu is shown.

- 2 Enter the code for "Check/Cancel TX Files" with the number keys.

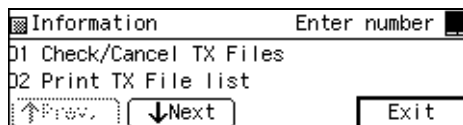

Note

- ❑ If "Check/Cancel TX Files" is not shown, press **[↑Prev.]** or **[↓Next]**.

- 3 Press the **[◀]** or **[▶]** key until the file you want to delete is shown and press **[Delete]**.

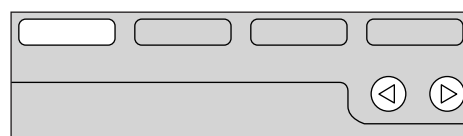
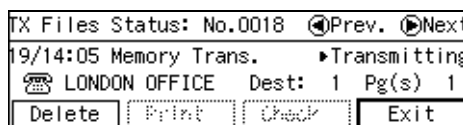

TKSS047N

4 Press [Yes].

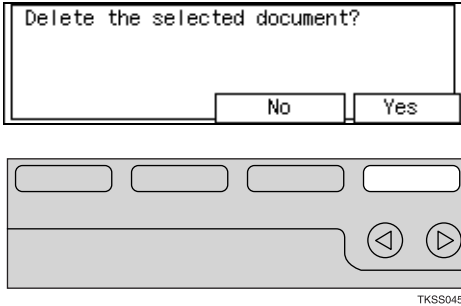

The file is erased.

5 Press [Exit].

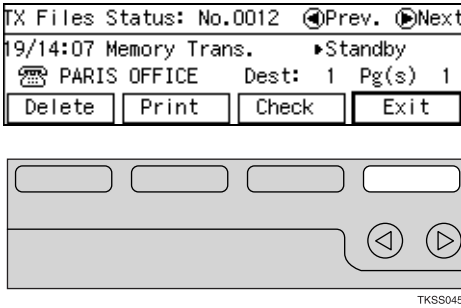

Note

- To delete another file, repeat steps **5** and **4**.
- If no faxes are on transmission standby, the display in step **6**.

6 Press [Exit].

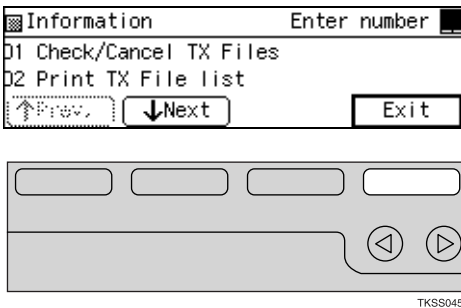

Canceling a Fax that is Awaiting Transmission

To cancel a message that is awaiting transmission, see P.143 "Canceling a Transmission".

Immediate Transmission

With Immediate Transmission, when you press the **[Start]** key, the fax number is dialed straight away (i.e. immediately). The message is scanned and transmitted page by page without being stored in memory. This contrasts with Memory Transmission which scans in all pages into memory before dialing the destination.

Immediate Transmission is useful if you want immediate confirmation that the message is being sent to the correct destination (just check the other terminal's RTI or CSI on the operation panel during transmission).

Note

- You cannot send the same message to multiple destinations (Broadcasting). Use Memory Transmission for this purpose.
- If the Back Up Transmission feature is turned on, you cannot send using Immediate Transmission.
- By default, the transmission mode selected when the machine is turned on or when modes are cleared (transmission mode home setting) is Memory Transmission. You can change this with the User Parameters.⇒ P.250 "Changing the User Parameters"

❖ Auto Redial

If a connection to the other party could not be made (e.g. because the line is busy), the machine redials up to twice at 1 minute interval.

❖ ECM (Error Correction Mode)

This feature automatically sends data that wasn't transmitted successfully again using a technique called ECM, an internationally recognized protocol (requires that the destination machine has the same feature).

1 Make sure that the Immediate Transmission indicator is lit.

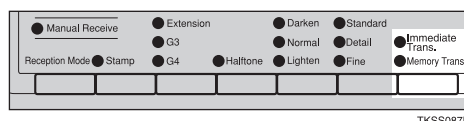

If it is not lit, press the **[Transmission Mode]** key.

2 Set your document.

Note

- You can set the document any time up until you press the **[Start]** key.

Reference

How to set a document, see P.50 "How to Set a Document".

3 Select any scan settings you require.

Reference

P.76 "Scan Settings"

4 Dial the destination number.

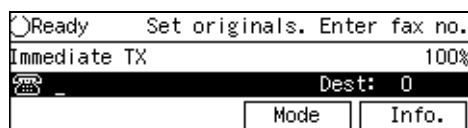

Note

- ❑ If you make a mistake, press the **[Clear]** key or **[Stop]** key and try again. The **[Clear]** key deletes one character at a time, and the **[Stop]** key deletes the whole line.
- ❑ If you are dialing with the number keys or Chain Dial (⇒ P.87), you can select the line to use (G3 or G4).

Reference

P.81 "Dialing"
 P.79 "Selecting the Line"

5 Press the **[Start]** key.

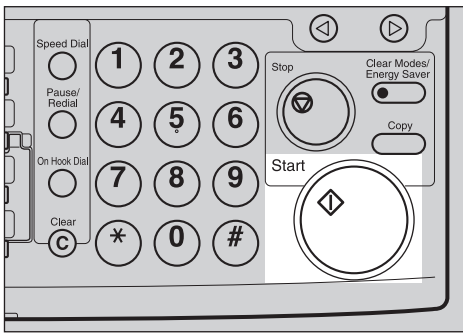

The machine calls the destination. While it is dialing, the number or name which is programmed as the RTI or CSI in the machine of the other party is shown on the display. When connected, the machine starts scanning the document.

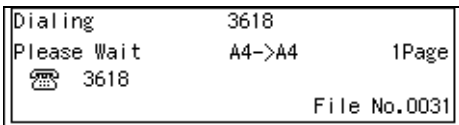

Reference

P.35 "Registering your RTI and TTI"

After transmission the machine will return to standby mode.

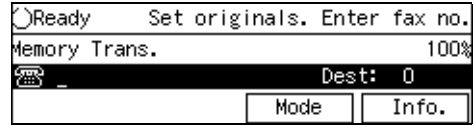

If the connection could not be made

- 1** If it was not possible to make a connection with the number you dialed (e.g. the line was busy or there is a line problem), the following display will appear:

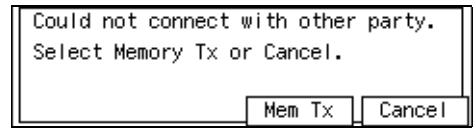

Redial and try and send the message by Memory Transmission

- 1** Press **[Mem Tx]**.

To have the machine redial and try and send the message by Memory Transmission. All documents will be scanned into memory then redialing will begin.

To cancel this transmission

- 1** Press **[Cancel]**.

The machine returns to the standby mode.

Redialing with Immediate Transmission

- 1** Press the **[Pause/Redial]** key.
- 2** Press the **[Start]** key.

Transmission Result Report

If you turn this report on, a report will be printed after every Immediate Transmission so you have a record of whether the transmission was successful or not.

 **Note**

- You can switch this report on or off with the User Parameters.⇒ P.250
“Changing the User Parameters”

Canceling an Immediate Transmission

Canceling a transmission before you have pressed the Start key

2

1 Press the **[Stop]** key.

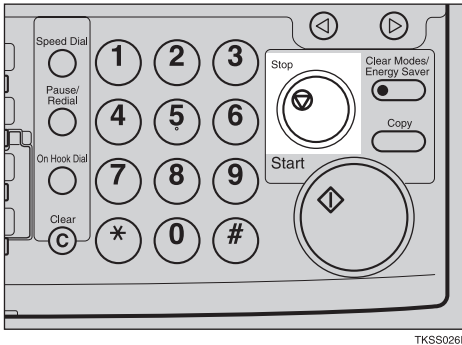

Note

- When your document is set in the ADF, you can also cancel Immediate Transmission by removing it.

Canceling a transmission after you have pressed the Start key

1 Press the **[Stop]** key.

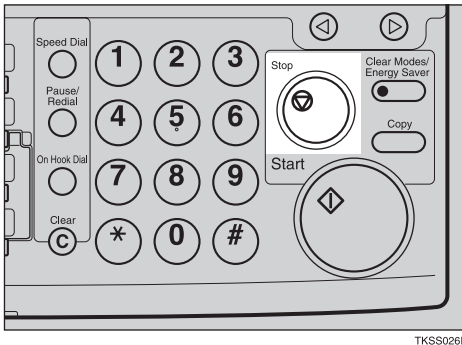

Note

- If the transmission finishes while you are carrying out this procedure, it will not be canceled.

2 Check the displayed message.

When there is a document Jam

1 Check the message on the display then press **[OK]**.

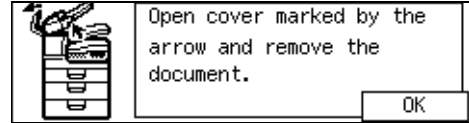

2 Remove the document.

Reference

P.180 "Clearing Document Jams"

On-Hook Dial

This is just like using a connected external telephone, except you do not have to pick up the handset before dialing. Just press the **[On Hook Dial]** key and dial the number. If you hear a voice, you can pick up the external telephone and speak with the other party.

⚠ Limitation

- This feature is not available in some countries.
- You cannot use this feature with the optional G3 unit.

📝 Note

- You can dial with the number keys, Quick Dials or Speed Dials.

🔍 Reference

P.245 "Monitor Volume"

- 1** Set your document and select any scan settings you require.

🔍 Reference

P.50 "How to Set a Document"

P.76 "Scan Settings"

- 2** Press the **[On Hook Dial]** key.

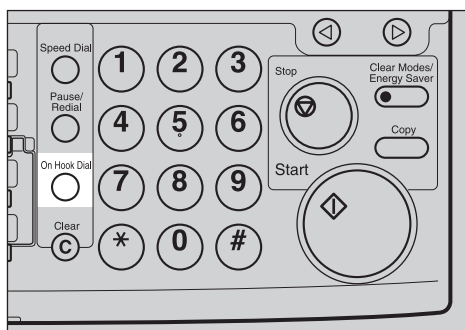

TKSS023E

You will hear a low tone from the internal speaker. If you wish to cancel this operation, press the **[On Hook Dial]** key again.

- 3** Dial.

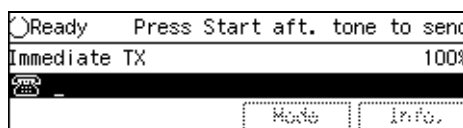

The machine dials each digit as you enter it. If you make a mistake, press the **[Stop]** key, **[On Hook Dial]** or **[Clear Modes/Energy Saver]** key and return to step **2**.

- 4** When a connection is made to another fax machine (you will hear a high-pitched tone), press the **[Start]** key.

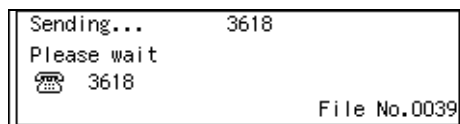

- If you hear a voice, pick up the external handset before you press the **[Start]** key and notify the destination that you want to send a fax message (ask them to switch to Fax mode).
- After transmission the machine will return to standby mode.

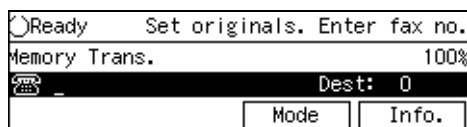

📝 Note

- If you wish to cancel transmission while it is in progress, press the **[Stop]** key then remove the document.

Using On Hook Dial with ISDN

This feature requires the optional G4 Unit.

When only connecting to an ISDN line, the On Hook Dial feature becomes available for ISDN.

The following example describes how to use this feature to connect to a fax information service.

Limitation

- You cannot use an external telephone with this function.

1 Press the [On Hook Dial] key.

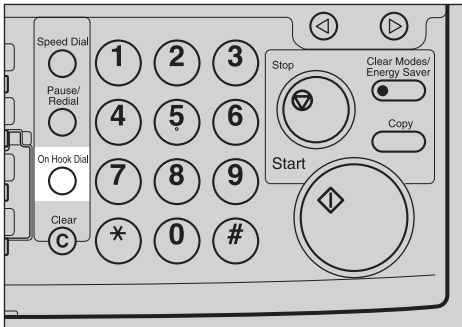

TKSS023E

2 Dial the fax number.

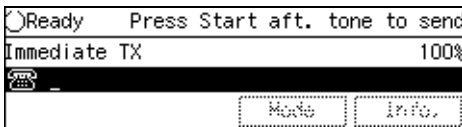

Limitation

- Do not pause for more than 5 seconds between dialing digits. If more than 5 seconds passes, transmission will start automatically.

Note

- If you make a mistake, press the [On Hook Dial] key or the [Clear Modes/Energy Saver] key and perform the operation again.
- You can also enter the sub-address and UUI. The correct input sequence is as follows: "Fax number" "/" Subaddress" "." "UUI"

3 Press [Dialing].

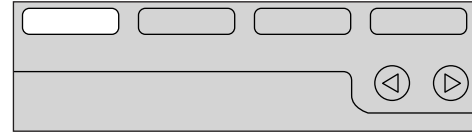

TKSS042N

Note

- Transmission will begin automatically 5 seconds after entering the fax number.

4 Follow the instructions provided by the other party.

5 When you hear a message such as "Please press the start button", press the [Start] key.

After a while, reception will begin. When reception has finished, the machine will return to standby mode.

Note

- If you wish to cancel reception while it is in progress, press the [Stop] key.

Manual Dial

An external telephone is required to use this function.

Pick up the external telephone and dial. When the line is connected and you hear a high-pitched tone, press the **[Start]** key to send your fax message. If, on the other hand, you hear a voice at the other end, continue your conversation as you would normally over the telephone.

Limitation

- Manual Dial does not work with ISDN lines.
- Results of transmissions with this feature are not mentioned in the Transmission Result Report .

Note

- You can specify destination with the number keys, Quick Dial or Speed Dial.
- If you lift the handset immediately after the machine switches to Night Timer mode, there will be no sound for a maximum of 4 seconds. When you can hear sound again, you can continue.

- 1** Set your document and select any scan settings you require.

Reference

P.50 "How to Set a Document"

P.76 "Scan Settings"

- 2** Pick up the external telephone.

You will hear a tone.

- 3** Dial.

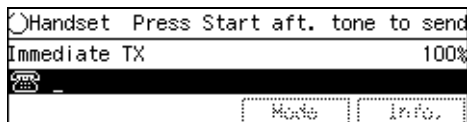

If you make a mistake, replace the external telephone and try again from step **2**.

- 4** When the line is connected and you hear a high-pitched tone, press the **[Start]** key to send your fax message.

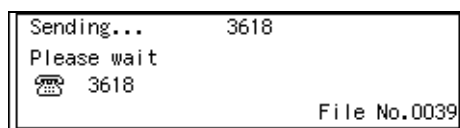

- 5** Replace the handset of the external telephone.

After transmission the machine will return to standby mode.

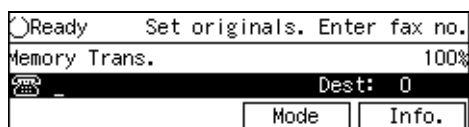

Note

- If you wish to cancel transmission while it is in progress, press the **[Stop]** key then remove the document.

Scan Settings

You may wish to send many different types of fax message. Some of these may be difficult to reproduce at the other end. However, your machine has three settings that you can adjust to help you transmit your document with the best possible image quality.

- ❖ **Resolution:**
Standard, Detail, Fine
- ❖ **Image density:**
Darken, Normal, Lighten
- ❖ **Halftone:**
Off, On

Resolution

Images and text are scanned into the machine by converting them to sequences of dots. The frequency of dots determines the quality of the image and how long it takes to transmit. Therefore, images scanned at high resolution (Fine) have high quality but transmission takes longer. Conversely, low resolution (Standard) scanning results in less quality but your document is sent more quickly. Choose the setting that matches your needs based upon this trade off between speed and image clarity.

- ❖ **Standard (8 × 3.85 lines/mm, 200 × 100 dpi)**
Select for documents containing normal sized characters.
- ❖ **Detail (8 × 7.7 lines/mm, 200 × 200 dpi)**
Select for documents containing small characters or when you require greater clarity. This resolution is twice as fine as Standard.

This setting scans documents using twice the resolution than that of the Standard setting.

- ❖ **Fine (8 × 15.4 lines/mm, 200 × 400 dpi)**
Select for documents with fine detail or when you require the best possible image clarity. This resolution is four times as fine as Standard.
This setting scans documents using four times the resolution than that of the Standard setting.

Limitation

- If the other party's machine does not support the resolution at which you are sending, this machine automatically switches to a resolution which is supported.

Note

- When the machine is turned on or modes are cleared, the resolution is set to Standard by default. You can change this with the User Parameters. ⇒ P.250 "Changing the User Parameters"
- By default, the resolution returns to the home setting after every transmission. You change this with the User Parameters. ⇒ P.250 "Changing the User Parameters"

1 Press the **[Resolution]** key to switch between resolutions. The indicators above the key show the current selection.

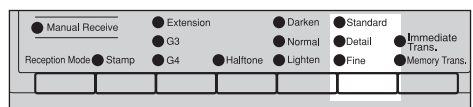

TKSS086N

Image Density

❖ Normal

This is the standard image density.

❖ Dark

Use if documents contain faint characters or handwriting.

❖ Light

Use if the image is dark and would otherwise be reproduced as black at the other end.

📌 Note

❑ When the machine is turned on or modes are cleared, the Image Density setting is set to Normal. You can change this with the User Parameters.⇒ P.250 “Changing the User Parameters”

❑ By default, the machine returns to the Image Density home setting after every transmission. You can change this with the User Parameters.⇒ P.250 “Changing the User Parameters”

1 Press the **[Image Density]** key until the appropriate indicator lights.

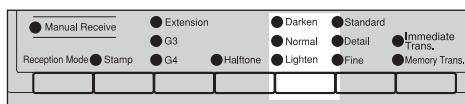

Halftone

If your document contains photographs, illustrations or diagrams with complex shading patterns or grays, select **Halftone** to optimize image clarity.

📌 Note

- ❑ If you select **Halftone**, the transmission will take longer than when off is selected.
- ❑ If the optional JBIG unit is installed, transmission time is shortened even if **Halftone** is selected.
- ❑ When the machine is turned on or modes are cleared, the **Halftone** is set to off. You can change this with the User Parameters.⇒ P.250 “Changing the User Parameters”
- ❑ By default, the machine returns to the **Halftone** home setting after every transmission. You can change this with the User Parameters.⇒ P.250 “Changing the User Parameters”

1 Press the **[Halftone]** key repeatedly until the indicator matching the type you require is lit.

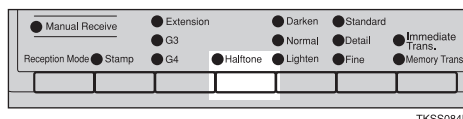

When both indicators are not lit, the **Halftone** settings is off.

Mixing Scan Settings in a Multiple Page Document

When sending a document consisting of several pages, you can select different Image Density, Resolution and for each page.

Set your document, select the scan settings for the first page, dial and press the **[Start]** key as you would normally. Then follow one of the following two procedures.

1 Check which pages you wish to make different scan settings for.

2 Select the Image Density, Resolution and Halftone before the next page is scanned.

<input type="radio"/> Manual Receive	<input type="radio"/> Extension	<input type="radio"/> Darken	<input type="radio"/> Standard		
<input type="radio"/> Reception Mode	<input type="radio"/> G3	<input type="radio"/> Normal	<input type="radio"/> Detail	<input type="radio"/> Immediate Trans.	
<input type="radio"/> Stamp	<input type="radio"/> G4	<input type="radio"/> Halftone	<input type="radio"/> Lighten	<input type="radio"/> Fine	<input type="radio"/> Memory Trans.
<input type="checkbox"/>	<input type="checkbox"/>	<input type="checkbox"/>	<input type="checkbox"/>	<input type="checkbox"/>	<input type="checkbox"/>

TKSS080N

2

Selecting the Line

This feature requires the optional G3 Unit or the optional G4 Unit.

Installing all of these options expands the machine's line capacity to a maximum of 2 lines.

The optional G3 Unit connects to the PSTN, the optional G4 Unit to the ISDN.

⚠ Limitation

- Up to two lines can be used simultaneously.
- The optional G3 unit and G4 unit cannot be used together simultaneously.
- When sending a fax and choosing the line, you can only specify destinations with the number keys and the Chain Dial feature.

❖ G3

G3 is selected by default after power on and a reset (⇒ P.20).

If the G3 indicator is not lit, press the **[Line Selection]** key until it is.

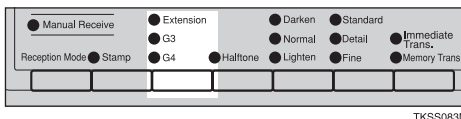

❖ Auto Display

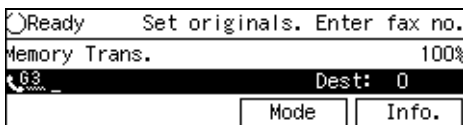

❖ G3-1 Display

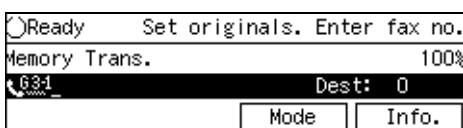

❖ G3-2 Display

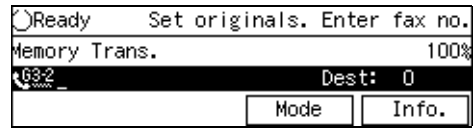

❖ ISDN-G3 Display

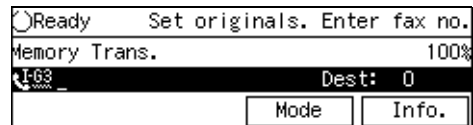

❖ G4

Press the **[Line Selection]** key to light the G4 indicator.

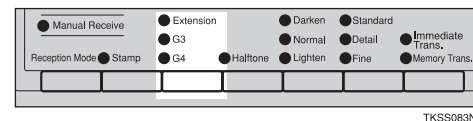

❖ G4 Display

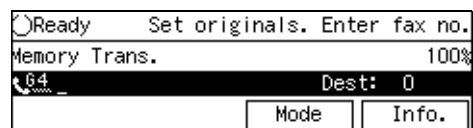

❖ Extension

Press the **[Line Selection]** key to light the Extension indicator.

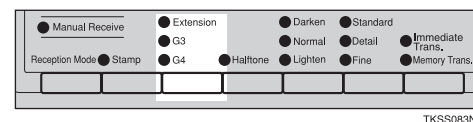

✎ Note

- To have the standard G3 line or optional extra G3 line treated as extension lines, adjust the User Parameters. By default, both lines are treated as outside lines.

❖ **G3 Line Selection**

G4 communication always uses ISDN, but G3 communication can use either PSTN or ISDN. Therefore, when connected to both PSTN and ISDN and selecting G3, you can choose which line to use.

Note

- When using G3 with ISDN, you can use the sub-address and UII.

❖ **Auto Discriminate**

This function is for when G4 is selected. The machine first dials using G4, but if the destination is PSTN, it switches automatically to G3.

Limitation

- This function requires the optional G4 Unit.

Note

- When the destination G3 uses TA (Terminal Identification) or is attached to a PABX, and connected to ISDN, it is detected as G4 and the machine does not switch to G3.

❖ **When you have stored the Line Select function in a User Function key**

When the optional G3 Unit or optional G4 Unit is installed, you can store the Line Select function in one of the User Function keys ((F1)-(F5)).

When sending a fax, pressing the User Function key enables you to select the line.

How to Select the Line

Preparation

Store the Line Select function in a User Function key ((F1)-(F5)).⇒ P.225 "Assigning User Function Keys"

1 Make sure that the G3 indicator is lit.

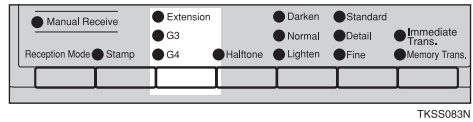

2 Press the User Function key ((F1)-(F5)) with the Line Select function stored in it.

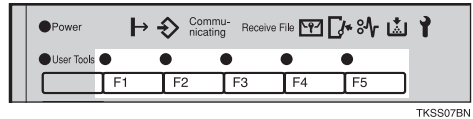

3 Press the (◀▶) keys to select the line.

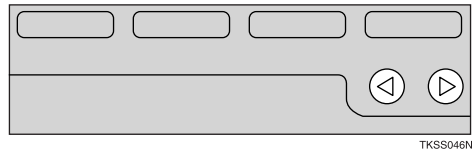
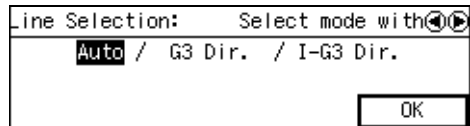

4 Press [OK].

Dialing

There are three main ways to dial a number:

❖ Number keys:

Enter numbers directly using the keypad on the right side of the operation panel.

❖ Quick Dials:

When you have stored a destination's number in a Quick Dial key, you can dial the number by just pressing that key. Additionally, you can store a name that will appear on the display whenever you press that Quick Dial.

❖ Speed Dials:

To dial a number stored in a Speed Dial, just press the Speed Dial key followed by a 2 or 3 digit code. Like Quick Dials, you can store a name along with the number.

This following section covers these features and others in more detail.

Number Keys

Enter numbers directly using the keypad on the right side of the operation panel.

Note

- Maximum length of a fax number: 254 digits.
- You can insert pauses and tones in a fax number. ⇒ P.82 "Pause", P.83 "Tone"
- If the optional G4 unit is installed, you can enter a subaddress or UUI. ⇒ P.87 "Sub-address"

❖ Restrictions when dialing with the Number Keys

Fax numbers entered with the number keys are stored in internal memory (separate from memory for storing document data). Therefore, you cannot program more than 100 numbers with the number keys in the following cases:

- Destinations specified in a Memory Transmission (including Confidential Transmission and Polling Reception)
- Transfer Stations and End Receivers specified in a Transfer Request
- Destinations and Transfer Stations specified in a Group

For example, when 90 destinations are registered in a Group with the Number keys, only 10 destinations can be dialed for Memory Transmission from the number keys.

Note

- When this machine is requested to transfer a call (i.e. becomes a Transfer Station), 2 fax numbers are automatically stored. Therefore, the number of destinations that can be dialed from the number keys decreases by two whenever this machine is requested to transfer a call.
- When a total of 100 fax numbers is stored, only Immediate Transmission is allowed.

- ❑ If a Group is defined when there are files queued for transmission, the message “Cannot add additional recipients: limit reached.” may be shown on the display and no additional fax numbers can be stored even if the number of destinations specified from the number keys is less than 100. That is because the fax numbers have been dialed from the number keys for some of the waiting files. When the waiting files have been sent and their fax numbers are deleted from memory, additional fax numbers can be dialed.
- ❑ The display shows the percentage of free space in memory for storing documents. Since fax numbers are stored in separate memory, dialing fax numbers from the number keys does not change the percentage on the display.

1 Set your document and select any scan settings you require.

Reference

- P.50 “How to Set a Document”
- P.76 “Scan Settings”

2 Enter the fax number with the number keys.

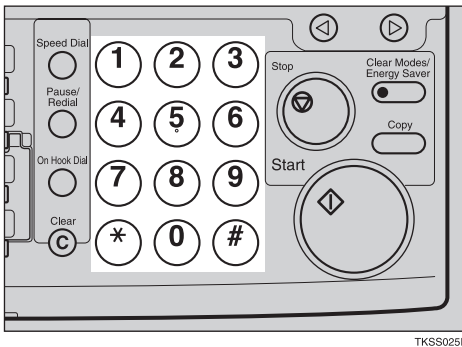

The digits appear on the display as you enter them.

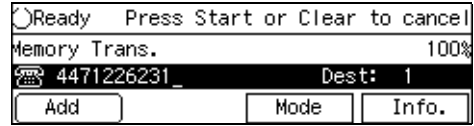

Note

- ❑ If you make a mistake, press the **[Stop]** key or **[Clear]** key and try again. The **[Clear]** key deletes one character at a time, and the **[Stop]** key deletes the whole line.
- ❑ If you wish to send this message to more than one destination, press **[Add]**, then enter the next destination.
- ❑ If the optional G4 unit is installed, select G3 or G4 before you go to the next step.⇒ P.79 “Selecting the Line”

3 Press the **[Start]** key.

Pause

Press the **[Pause/Redial]** key when dialing or storing a number to insert about a two-second pause.



Limitation

- ❑ You cannot insert a pause before the first digit of a fax number.

 **Note**

- A pause is shown as a “-” character on the display.
- You can insert a pause in numbers stored in Quick Dials and Speed Dials.

Tone

This feature allows a machine connected to a pulse dialing line to send tonal signals (for example if you want to use a special service on a tone dialing line). When you press the User Function key assigned with the Tone feature, the machine dials the number using tonal signals.

 **Preparation**

You need to assign the Tone feature to a User Function key beforehand.

 **Limitation**

- You cannot place a tone before the first digit of a fax number.
- Some services may not be available when using the Tone feature.

 **Note**

- A tone is shown as a “•” on the display.

 **Sending tone signals by ISDN (ISDN option Required)**

You can still send tone signals to a G3 user even if the machine is only connected to an ISDN line.

 **Note**

- This feature can only be used for Memory or Immediate Transmission. You cannot dial through ISDN using Manual Dial. When only connected to ISDN, you can use On Hook Dial.

SUB Code Transmission

Normally you can only use Confidential Transmission or Transfer Request to send to fax machines of the same make that have the Confidential Reception or the Transfer Request feature. However, if the other machine supports a similar feature called SUB/SID, you can send fax messages to the other party using this method instead.

You can also use SUB code Transmission to send messages to Personal Boxes and Transfer Boxes registered in other fax machines.

 **Preparation**

You need to assign the Dial Option feature to a User Function key beforehand.

You can only use this feature in a G3 communications (not with G4).

You cannot use Chain Dial with this feature.

 **Note**

- The ID can be up to 20 digits long and consist of digits, spaces, * and #.
- Make sure the ID matches the specification of the fax you are sending to.
- You can store IDs in Quick Dials, Speed Dials, Groups and Programs.
- Messages you send using this feature are marked “SUB” on the reports below:
 - File Reserve Report (Memory Transmission)
 - File Reserve Report (Polling Reception)
 - Communication Result Report

- Communication Failure Report
- Transmission Result Report

1 Set your document and make any changes to the scan settings if necessary.

2 Dial the destination fax number using the number keys.

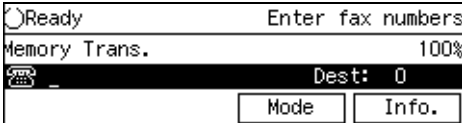

3 Press the User Function key assigned with the Dial Options feature.

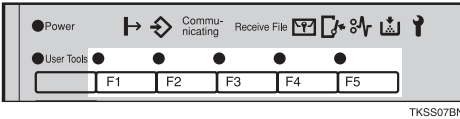

4 Enter the code for "SUB" with the number keys.

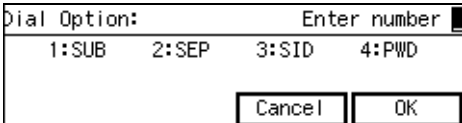

5 Enter the SUB code with the number keys, then press [OK].

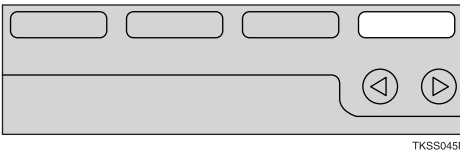
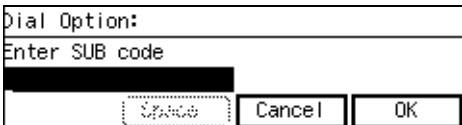

When a password (SID) is necessary

1 Enter the code for "SID" with the number keys.

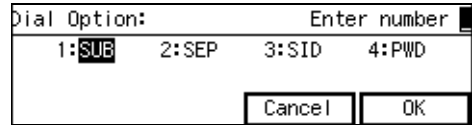

2 Enter the SID code then press [OK].

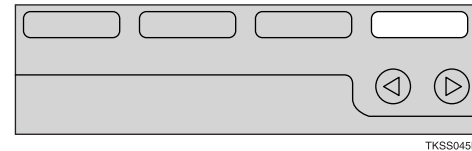
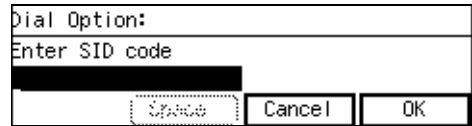

6 Press [OK].

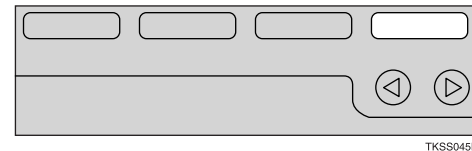
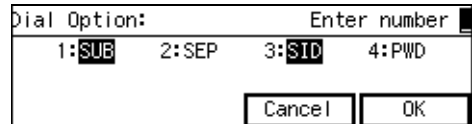

7 Press the [Start] key.

Note

- ❑ If you use Immediate Transmission and the destination fax machine does not support the SUB/SID feature, a message will appear on the display to inform you of this. In this case, press [OK] to cancel the transmission.

SEP Code Polling Transmission

Normally you can only use Polling Transmission/Reception between fax machines of the same make that have the Polling Transmission/Reception feature. However, if the other machine supports a similar feature called SEP/PWD, you can send fax or receive messages using this polling method instead.

You can also use SEP Code Polling Transmission to retrieve documents stored in information Boxes registered in other fax machines.

Preparation

You need to assign the Dial Options feature to a User Function key beforehand.

Limitation

- The ID can be up to 20 digits long and consist of digits, spaces, * and #.

Note

- Messages you send using this feature are marked “SEP” on the reports below:
 - File Reserve Report (Memory Transmission)
 - File Reserve Report (Polling Reception)
 - Communication Result Report
 - Communication Failure Report
 - Transmission Result Report
- Make sure that the ID you enter conforms with the specification of the other party's fax machine.

1 Press [Mode].

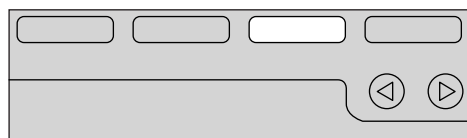
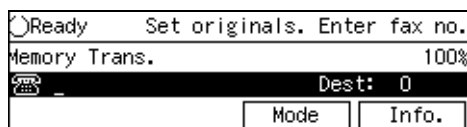

TKSS044N

Note

- The “Transmission Mode” menu appears.

2 Enter the code for “Polling RX” with the number keys.

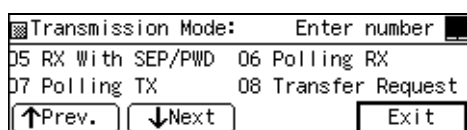

Note

- If the appropriate display is not shown, press [**Prev.**] or [**Next**].

3 Press the **◀** or **▶** key to select the Default ID and press [OK].

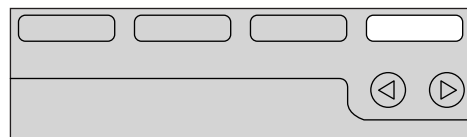
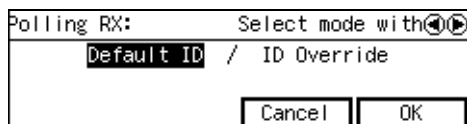

TKSS045N

Note

- To cancel Polling Reception, Press [**Cancel**]. The Transmission Mode menu is shown.

4 Press [Exit].

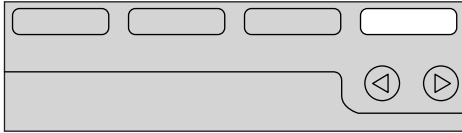

TKSS045N

The Transmission Mode menu is shown. A check mark is added to Polling Reception.

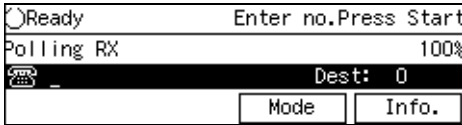

5 Dial the destination fax number using the number keys.

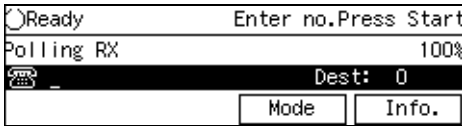

6 Press the User Function key assigned with the Dial Options feature.

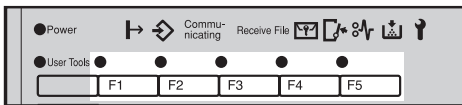

TKSS07BN

7 Enter the code for "SEP" with the number keys.

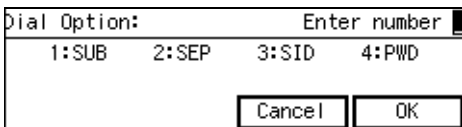

8 Enter the SEP code with the number keys, then press [OK].

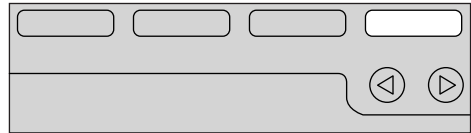
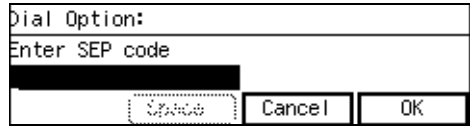

TKSS045N

When a password (PWD) is necessary

1 Enter the code for "PWD" with the number keys.



2 Enter the PWD code then press [OK].

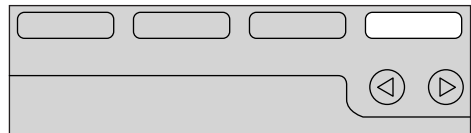
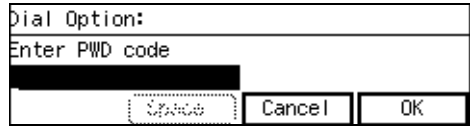

TKSS045N

9 Press [OK].

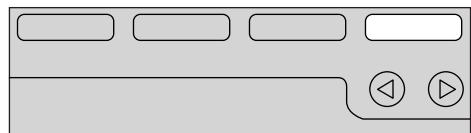
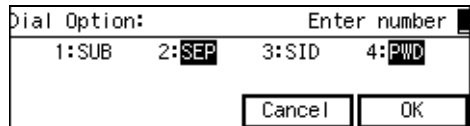

TKSS045N

10 Press the [Start] key.

Sub-address

The optional G4 Unit is required to use this function

Preparation

You need to assign the sub-address feature to a User Function key beforehand. ⇒ P.225 "Assigning User Function Keys", ⇒ P.199 "Registering Groups"

ISDN allows two or more terminals (such as a fax and digital telephone) to be connected to a single line. These terminals are identified by their sub-address numbers. If the terminals connected to the line at a destination are assigned sub-addresses, dialing a sub-address allows you to direct your fax message to a particular terminal at the destination.

Limitation

- Sub-address can only be used with ISDN.

Note

- You can program a sub-address number in a Quick Dial or Speed Dial.

- 1** Select G4 or ISDN-G3.
- 2** Set your document and make any changes to the scan settings if necessary.
- 3** Dial the fax number with the number keys.

- 4** Press the User Function key (**[F1]**-**[F5]**) in which the sub-address function has been registered.

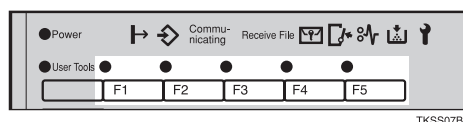

"/" will appear on the display.

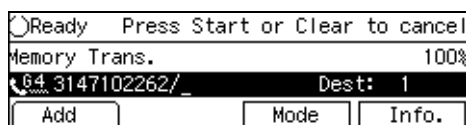

- 5** Enter the destination sub-address with the number keys.

- 6** Press the **[Start]** key.

Chain Dial

This allows you to compose a telephone number from various parts, some of which may be stored in Quick Dials or Speed Dials and some of which may be input using the number keys.

Limitation

- Maximum length of telephone or fax number: 254 digits

Note

- For Memory Transmission and Immediate Transmission, insert a pause between numbers. For On-hook Dial and Manual Dial, no pause is needed.

❖ (Example) 01133-1-555333

Assume that 01133 is stored in Quick Dial 01 and that 555333 is stored in Speed Dial 01.

- ① Place the document and select any scan settings you require.
- ② Press Quick Dial key **[01]**.

- ③ Press the **[Pause/Redial]** key.
- ④ Press **[1]** using the number keys.
- ⑤ Press the **[Speed Dial]** key and **[0]** and **[1]** using the number keys.
- ⑥ Press the **[Start]** key.

2

Dialing with Quick Dials

When you have stored a destination's number in a Quick Dial key, you can dial the number by just pressing that key.

Additionally, you can store a name that will appear on the display whenever you press that Quick Dial.

 **Note**

- To check the contents of the Quick dial, print the list. ⇒ P.223 "Reports/Lists"
- If the Quick Dial key is used as other functions like Groups, you cannot program the Quick Dial in it.
- Flip the Quick Dial plate over to access Quick Dial keys 01-32 or 33-64.
- You can have the label stored with a Quick Dial printed on the first page received at the other end. ⇒ P.196 "Label Insertion"

1 Set your document and select any scan settings you require.

2 Press the Quick Dial key in which the destination's number is programmed.

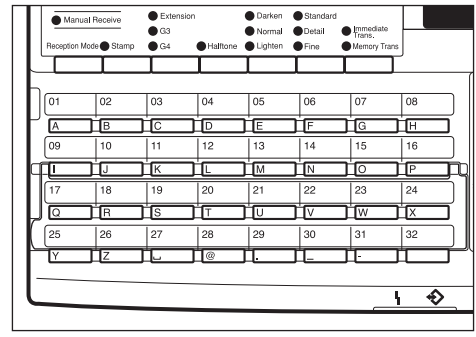

TKSS050N

If the destination's name has been stored, the name is shown on the display. Otherwise, the fax number is shown.

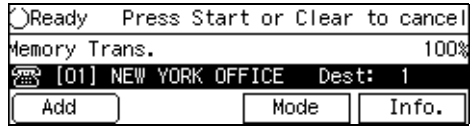

 **Note**

- If you make a mistake, press the **[Clear]** key or **[Stop]** key and try again. The **[Clear]** key deletes one character at a time, and the **[Stop]** key deletes the whole line.
- If you wish to dial another destination, press **[Add]** and dial another fax number.

3 Press the **[Start]** key.

Dialing with Speed Dials

If you store a number in a Speed Dial, when you want to dial it, just press the **[Speed Dial]** key and enter a 2 or 3 digit code. ⇒ P.209 "Registering Speed Dials"

Note

- To check the contents of all Speed Dials, print the Speed Dial list.
- As standard, you can use codes 00-99 for Speed Dials. If the optional Function Upgrade Card is installed, codes 000 to 999 become available.
- If a search letter is registered with a Speed Dial, you can find this number quickly using the Telephone Directory feature.⇒ P.89 "Telephone Directory"
- You can have the label stored with a Speed Dial printed on the first page received at the other end.⇒ P.211 "Turning Label Insertion on"

1 Place your document and select any scan settings you require.

2 Press the **[Speed Dial]** key.



TKSS021E

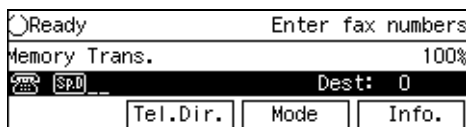

3 Enter the two-digit code (00 to 99) or three-digit code (000 to 999) of the Speed Dial with the number keys.

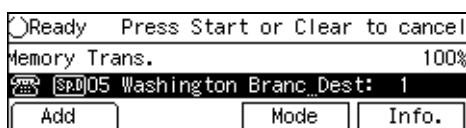

If the destination's name has been programmed, it flashes up on the display. Otherwise, the fax number appears.

Note

- When the optional Function Upgrade Card is installed, enter a Speed Dial code in the range 000 to 999.
- If you make a mistake, press the **[Clear]** key or **[Stop]** key and try again. The **[Clear]** key deletes one character at a time, and the **[Stop]** key deletes the whole line.
- If you wish to dial another destination, press **[Add]** and dial another fax number.

4 Press the **[Start]** key.

Telephone Directory

This feature lets you find a stored Speed Dial quickly by just entering a single letter, e.g., the first letter of the name stored for that number.

Preparation

To use the Telephone Directory function, you need to register a search letter when you program Speed Dials.⇒ P.209 "Registering Speed Dials"

Limitation

- Speed Dial codes cannot be searched for by symbol or number.

1 Set your document and select any scan settings you require.

2 Press the **[Speed Dial]** key.

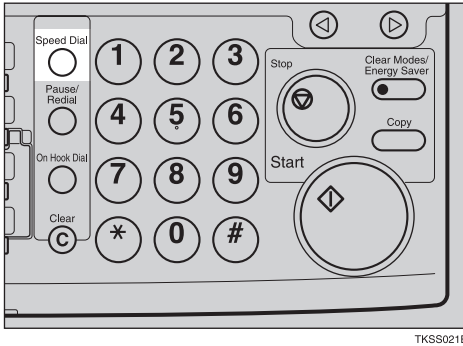

TKSS021E

3 Press **[Tel.Dir.]**.

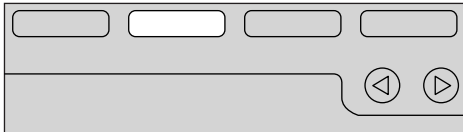
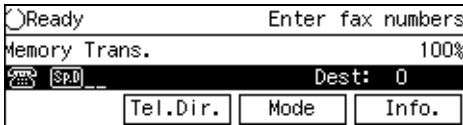

TKSS043N

4 Enter the search letter by pressing one of the Quick Dial keys (A to Z).

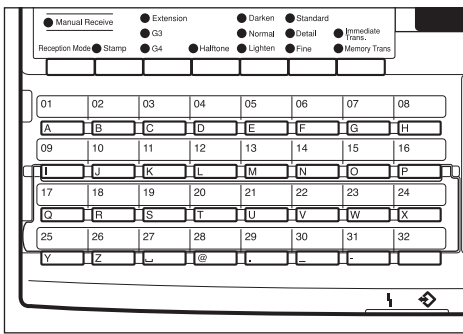

TKSS050N

The names or fax numbers registered in Speed Dials are shown in numerical order on the display.

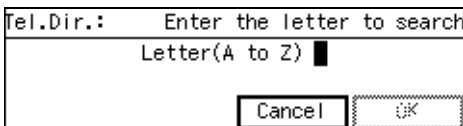

5 Enter the two-digit code (00 to 99) or three-digit code (000 to 999) of the Speed Dial with the number keys.

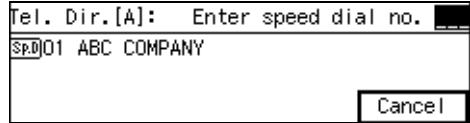

Note

- When the optional Function Upgrade Card is installed, enter a Speed Dial code in the range 000 to 999.
- If the list does not contain the desired destination, press **[↑Prev.]** or **[↓Next.]**.
- If you make a mistake, press the **[Clear]** or **[Stop]** key to try again. The **[Clear]** key deletes one character at a time, and the **[Stop]** key deletes the whole line.
- If you wish to dial another destination, press **[Add]** and dial another fax number.

6 Press the **[Start]** key.

Dialing with Groups

If you frequently send the same message to more than one place, program these numbers into a Group. Then you can send the messages to all the destinations in that Group with just a few keystrokes. You can also program a name for the Group (for example, "Branch Offices") which will be displayed before you press the **[Start]** key.

Note

- To check the contents of Groups, print the Group Dial List.

- You can program up to 9 Groups.
- When the optional Function Upgrade Card is installed, enter a Groups code in the range 01 to 30.
- You can store up to 250 destinations in a Group. If a Quick Dial or Speed Dial is registered in two Groups, it takes up the space of one destination.
- Groups can contain Transfer Station codes, but note that these Groups cannot be used for normal transmission because the Transfer Station codes are not dialable numbers. ⇒ P.203 "Multi-step Transfer Group settings"

To specify Group Number

Preparation

You need to assign the Group Dial feature to a User Function key and register Groups beforehand. ⇒ P.225 "Assigning User Function Keys"

- 1** Make sure the Memory Transmission indicator is lit.

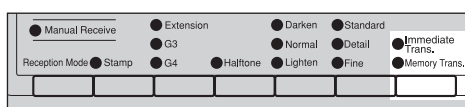

If it is not, press the **[Transmission Mode]** key.

- 2** Set your document and select any scan settings you require.
- 3** Press the User Function key with the Group Dial function stored in it.

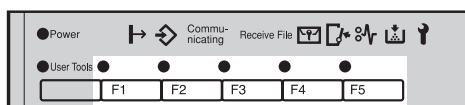

- 4** Enter the two-digit code (01 to 09) of the Group number with the number keys.

The Group number is shown on the display. If the Group name is programmed, the name is also shown on the display.

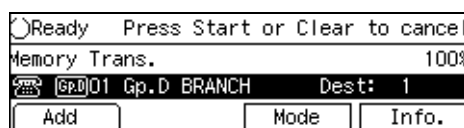

Note

- If you make a mistake, press the **[Clear]** key or **[Stop]** key and try again.
- If you wish to dial another destination, press **[Add]** and dial another fax number.

- 5** Press the **[Start]** key.

To specify Group stored in a Quick Dial

Preparation

You need to register Groups and assign the Group to a Quick Dial key beforehand. ⇒ P.199 "Registering Groups"

- 1** Make sure the Memory Transmission indicator is lit.

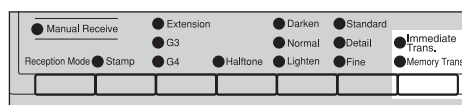

If it is not, press the **[Transmission Mode]** key.

- 2** See your document and select any scan settings you require.

3 Press the Quick Dial key in which the Group is programmed.

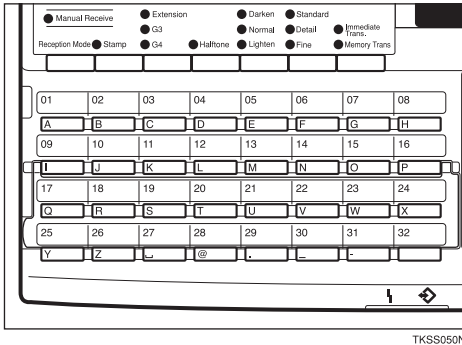

The Group number is shown on the display. If the Group name is programmed, the name is also shown on the display.

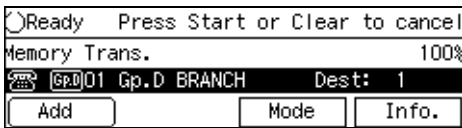

Note

- If you make a mistake, press the **[Stop]** key or **[Clear]** key and start again.
- If you wish to dial another destination, press **[Add]** and dial another fax number.

4 Press the **[Start]** key.

Redialing Numbers

The machine memorizes the last 10 destinations that have been dialed. If you wish to send a message to a destination which you faxed to recently, the Redial feature saves you finding and entering the number again.

Limitation

- The following kinds of destinations are not memorized:
 - Group Dials

- Destinations dialed by a Key-stroke Program
- Destinations dialed as End Receivers for Transfer Request
- Destination of Memory File Transfer
- Destinations dialed using the external telephone keypad
- Destinations dialed by Redial (regarded as already memorized)
- Any destinations after the first number if multiple destinations were dialed.

- Do not dial any digits before you press the Redial key. If you press the **[Pause/Redial]** key after entering digits using the number keys, a pause will be entered instead.
- The machine only remembers the most recent single number that was dialed with a Quick Dial or Speed Dial. If a transmission takes place dialing with the number keys after sending using a Quick Dial or Speed Dial, the previous 10 memorized numbers are erased.

1 Press the **[Pause/Redial]** key.



- 2** A list of previously dialed numbers will flash up. If you cannot see the number you need use the [↑Prev.] and [↓Next] keys to scroll through them. Then enter the code of the number you wish to redial e.g., "01".

Redial: Enter no. of destination	
D1 471312262	02 471316626
D3 226231471	04 7645
↑Prev.	↓Next
Cancel	

 **Note**

- If the receiver uses a fax of the same manufacturer that is capable of registering the RTI, that name may be shown on the display instead of the fax number.

Sending a Fax Using a Program

If you store a combination of settings by registering a series of key presses in a Program, you can have these settings applied to a transmission by just pressing a Quick Dial or entering a Speed Dial code.

2

Preparation

You must store the program in a Quick Dial or Speed Dial beforehand. ⇒ P.213 "Storing Keystroke Programs"

Limitation

- ❑ Keystroke Programs can only be stored in Speed Dials when the optional Function Upgrade Card is installed.

1 Make sure the Memory Transmission indicator is lit.

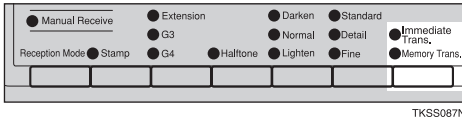

2 Set your document.

3 Do one of the following:

To Specify a Program Stored in a Quick Dial

1 Press a Quick Dial key with the program stored in it.

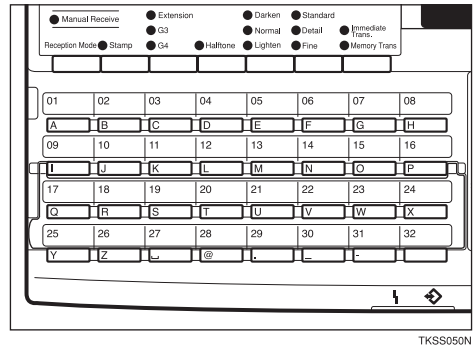

To Specify a Program Stored in a Speed Dial

1 Press the [Speed Dial] key.

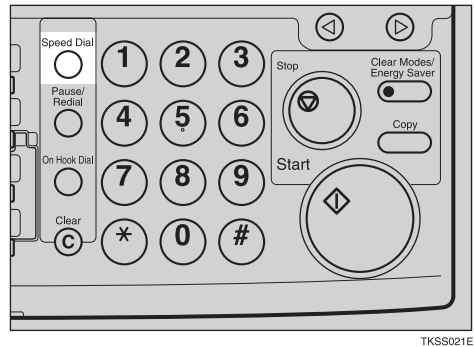

2 Enter the code of the Speed Dial with the program stored in it.

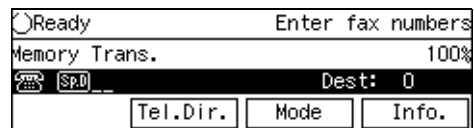

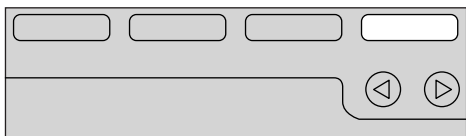
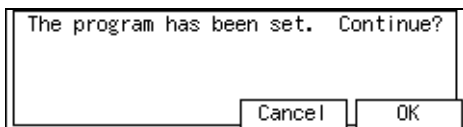
4 Press [OK].

TKSS045N

5 Press the [Start] key.

The machine starts scanning the document.

Transmission Features

No Document, No Dial

If you dial a destination fax number and for some reason take your document back to your desk and another person sets a different document, their document could be sent to the wrong destination. To avoid such mistakes, when this feature is turned on you cannot dial a destination unless your document is set.

Note

- When the machine is shipped, this feature is turned off by default. If you wish to turn this feature on, please contact your service representative.

Stamp

When sending a fax message, the machine can stamp a circle mark at the bottom of the document. This stamp indicates that the document has been successfully stored in memory for Memory Transmission, or that it has been successfully sent for Immediate Transmission.

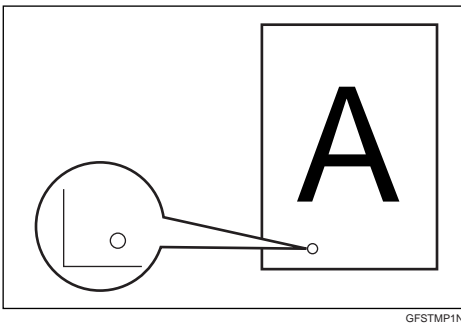

Limitation

- The Stamp feature does not apply to copy mode.

Note

- When the stamp starts getting lighter, replace the cartridge. ⇒ P.331 "Replacing the Stamp Cartridge"
- If a page was not stamped even though the Stamp feature is turned on, you need to re-send that page.
- By default, Stamp is turned off. If you use this feature often, you can adjust the User Parameters so that the home setting is on. In this case, Stamp can easily be turned off for any single transmission by pressing the **[Stamp]** key. ⇒ P.250 "Changing the User Parameters"

1 Press the **[Stamp]** key.

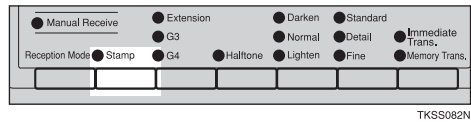

The Stamp indicator will light. Pressing the **[Stamp]** key again will turn it off.

Auto Reduction

If the other party's fax machine does not have paper loaded of the same width as your document, use this feature to have your document image reduced to a suitable width during transmission.

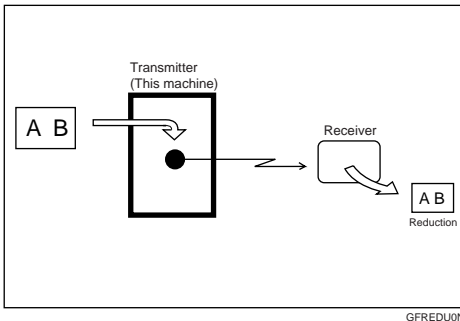

Important

- If you turn this feature off, the scale of the document is maintained and some parts of the image may be lost when printed at the other end.

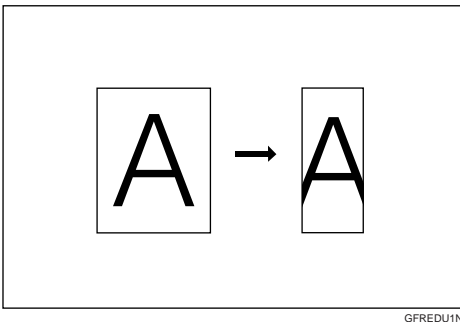

Note

- You can switch this feature on and off with the User Parameters(⇒ P.250). The default setting is on..

Duplex Original Settings

This feature lets you scan in each side of a double-sided document, then have both sides sent in a single operation.

Preparation

You need to store the Duplex Original function in a User Function key beforehand.

Limitation

- This feature is only available with Memory Transmission.

- 1** Make sure the Memory Transmission indicator is lit.

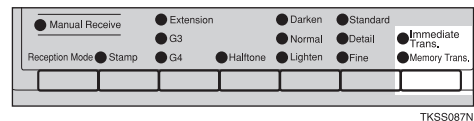

Note

- If it is not, press the [Transmission Mode] key.

- 2** Press the [User Function] key with the Duplex Original function stored in it.

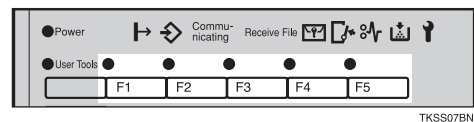

- 3** Set your double-sided document with the front page face-up.

- 4** Adjust any scan settings as necessary.

- 5** Dial the destination number.

- 6** Press the [Start] key.

Scanning of the front page will begin.

When scanning has finished, the following display will appear:

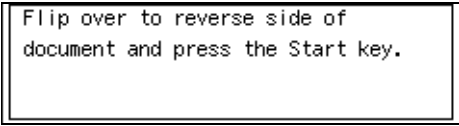

2

7 Set your document with the back page face-up.

Note

- Set the document within 60 seconds. If time runs out, an error will occur and transmission will not take place.

8 Press the **[Start]** key.

Label Insertion

With this feature you can have the receiver's name printed on the message when it is received at the other end. The name will be printed at the top of the page and will be preceded by "To".

Limitation

- If you select Label Insertion, the label might be printed over a portion of the image when received at the other end.

Auto Document

You can send an Auto Document along with another document, or just send it on its own.

Limitation

- Although you can specify scan settings when sending an Auto Document, these settings will only apply to the document you send along with the Auto Document. The settings used when you scanned in and stored the Auto Document will apply to the Auto Document itself.

Note

- If you send another document with an Auto Document, the Auto Document is sent first.
- To send just an Auto Document, start the following procedure from step **2**.

1 Set the document you wish to send along with the Auto Document, and adjust scan settings as necessary.

2 Specify the Auto Document to send in one of the following ways:

- Press the Quick Dial it is stored in.
- Press the **[Speed Dial]** key and enter the code of the Speed Dial it is stored in.

3 Press **[Yes]**.

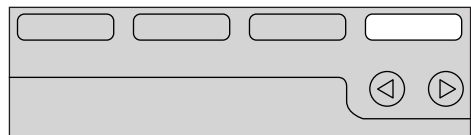
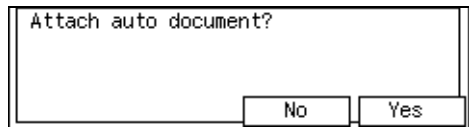

TKSS045N

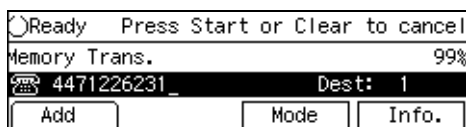
4 Dial the destination fax number.**5** Press the **[Start]** key.**TTI/CIL Print**

When you send using G3, your TTI is printed on faxes when received at the other end. When sending using G4, the CIL is printed on faxes at the other end.

Note

- If the CIL is added, the following information is printed on all pages:
 - The receiver's own number and ID
 - The sender's (i.e. this machine's) own number and ID
 - The communication time
 - Page number
- By default, TTI/CIL Print is turned on when the machine is shipped. For how to change this setting, see P.250 "Changing the User Parameters".

ID Transmission

If you use this feature, transmission is limited to destination machines of the same make and with the same stored Polling ID. This is useful when sending documents containing confidential or sensitive information.

Preparation

You need to program the Polling ID beforehand. ⇒ P.266 "Registering ID Codes"

Limitation

- ID Transmission is not available with the following functions:
 - Polling Transmission (⇒ P.134)
 - Backup Transmission (⇒ P.100)

Note

- When the machine is shipped, this feature is turned off by default. Turn in on or off with the User Parameters.

Skip Transmission

This feature requires the optional Function Upgrade Card.

By storing the scan area beforehand, only the designated area of the document page will be scanned and sent.

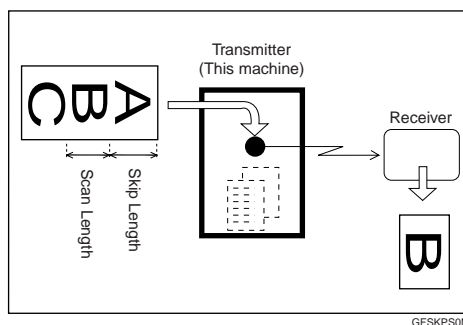
**Preparation**

You need to store the Skip Transmission feature in a User Function key beforehand.

Limitation

- You can only store one scan area.
- Skip Transmission is not available with the following features:
 - Immediate Transmission (⇒ P.69)
 - On Hook Dial Transmission (⇒ P.73)

- Manual Dial Transmission (⇒ P.75)
- Parallel Memory Transmission (⇒ P.64)

 **Note**

- Transmission time is shorter compared to sending the whole page. This feature is useful, for example, when you do not need to send the whole page, or when the page contains confidential information.
- Specify the scan area with the Program Scan Area setting.⇒ P.302 *“Program Scan Area”*
- When the machine is shipped, this feature is turned off by default. To turn it on, adjust the User Parameters.⇒ P.250 *“Changing the User Parameters”*

Backup File Transmission

When turned on, this feature sends a backup copy of all faxes you send to a destination that you can specify.

 **Preparation**

You must specify the backup destination beforehand.⇒ P.300 *“Backup File Transmission Settings”*

 **Limitation**

- This function works with the following features:
 - Memory Transmission
 - Transfer Request Transmission
 - Confidential Transmission
 - SUB Code Transmission
 - Mail Transmission (optional NIC FAX Kit required)

JBIG Transmission

Optional JBIG Unit required.

If you use JBIG (Joint Bi-level Image Experts Group) compression you can send photographic documents at high speed.

Normally, the JBIG method is used when sending to other fax machines. However, if connected to multiple lines and another JBIG transmission is in progress, transmission takes place without using JBIG.

 **Limitation**

- This feature requires that the other party's fax machine has both the JBIG function and ECM function (G3 communication only).
- When connected to multiple lines and a JBIG transmission is in progress, JBIG transmission is not possible until that transmission has finished.

 **Note**

- You can have the JBIG transmission feature selected when you press the **[Halftone]** key. Contact your service representative for details.

3. Receiving a Fax Message

Immediate Reception

Each page of a received fax message is printed as soon as it is received. This method is used for standard fax messages.

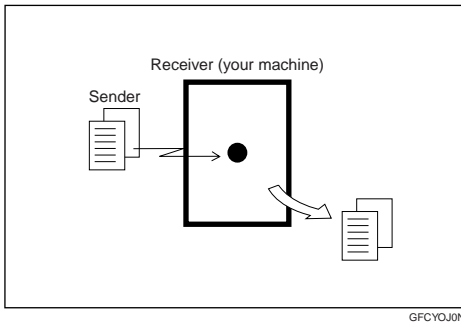

❖ Display during reception

The sender's RTI or CSI appears on the first line.

A4	P.1	Washington Branch
Memory Trans.		99%
Dest: 0		
Mode		Info.

❖ Reception resolution

This machine supports Standard and Detail resolutions. Even if the sender specifies the resolution as Fine or Super Fine, this machine will receive images as Detail. This may cause faxes to appear slightly different at your end than the sender intended.

Memory Reception

The machine waits until all pages of the message have been received into memory before printing the message.

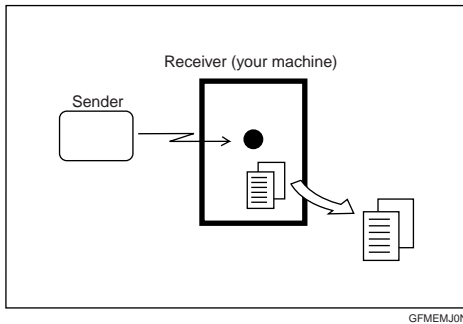

This method is used with the following features:

- Two In One(⇒ P.113)
- Image Rotation(⇒ P.114)
- Rotate Sort(⇒ P.114)
- Collate(⇒ P.276)
- Forwarding(⇒ P.111)
- TX/RX File Save(⇒ P.160)

⚠ Important

- If the functions listed above are turned on, you may not be able to receive very large or detailed faxes. If this happens, we recommend that you turn these functions off.
- If power is turned off for more than 1-hour, documents saved in memory are deleted.

💡 Limitation

- The machine may not be able to receive fax messages when the free memory space is low.

📌 Note

- If the memory free space reaches 0% during Memory Reception, the machine can no longer receive the current fax message and stops communicating.
- If free memory reaches 0% when printing messages received with any of the following functions, only the next fax is received using Immediate Reception:
 - Image Rotation
 - Two In One
 - Collate

Substitute Reception

If any of the conditions listed below are met, the machine automatically switches to Memory Reception mode and stores messages in memory instead of printing them. This reception mode, in which a received fax message is stored in memory and not printed, is called Substitute Reception. Messages received using Substitute Reception are automatically printed when the condition which caused the machine to use Substitute Reception is rectified. Substitute Reception takes place when:

- Paper runs out
- Toner runs out
- Paper is jammed
- The side cover is open
- A fax is received during a copy or print run

Limitation

- Reception may not take place if there is not enough free memory left.

Note

- The **Receive File** indicator lights to let you know when message(s) have been received using Substitute Reception.

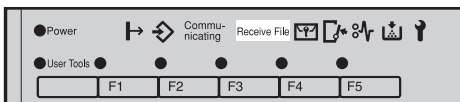

- By default this feature is turned on. Switch it off with the User Parameters.

- If free memory reaches 0% during Substitute Reception, any further reception becomes impossible and the current communication is terminated.

Screening Messages From Anonymous Senders

To help you screen out unwanted messages that may fill up your memory, the machine can be programmed to only use Substitute Reception for messages that arrive with RTI/CSI identification.

Two settings are available:

- “When RTI or CSI is received”
- “Free”

Note

- The default setting is “When RTI or CSI is received”, i.e. only store messages when the RTI/CSI is present. You can change this with the User Parameters.⇒ P.250 “Changing the User Parameters”

When RTI or CSI is received

The machine switches to Substitute Reception only when the sender has programmed their RTI or CSI. If the power is switched off for more than an

hour, all the messages received into memory are deleted. In such a case, the Power Failure Report or the Journal can be used to identify which messages are lost so you can ask the senders to transmit them again.

 **Important**

- ❑ If a sender has not programmed their RTI or CSI, the machine may reject an important fax message. We recommend that you ask important senders to register an RTI or CSI in advance.

 **Free**

The machine switches to Substitute Reception regardless of whether or not the sender has programmed their RTI or CSI.

Selecting the Reception Mode

There are two ways you can set up your machine to handle incoming calls:

- Fax mode (Auto Receive Mode)
- Tel mode (External telephone required)

Fax Mode (Auto Receive Mode)

When a telephone call comes in, the machine receives it automatically as a fax message. Use this setting for a dedicated fax line.

Telephone Mode

When a call comes in, you have to pick up the external telephone and decide whether the call is a fax message yourself. If you hear a voice, continue your conversation as you would using a normal telephone. If you hear high pitched beeps, instruct the machine to receive the fax by following the procedure below.

Use this setting if you wish to share the line between the fax machine and a telephone.

Receiving a fax in Telephone Mode

- 1 When the machine rings, pick up the handset.
- 2 If you hear beeps, press the **[Start]** key.
- 3 Replace the handset. The machine will start receiving.

How to Select the Reception Mode

- 1 Press the **[Reception Mode]** key.

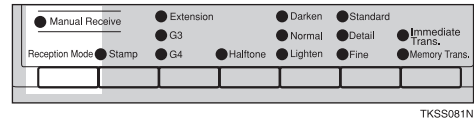

- 2 Press **⏪** or **⏩** to select the reception mode.

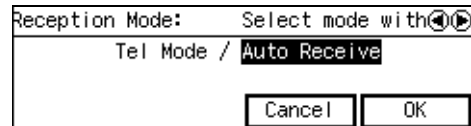

- 3 Press **[OK]**.

Note

- ❑ To cancel the selection and return to the fax standby mode, press **[Cancel]**.

Reception Functions

Transfer Station

Transfer Stations allow you to expand the standard features of your fax machine to set up complex networks. Transfer Stations must be machines of the same make.

The diagram below may make the concept clearer.

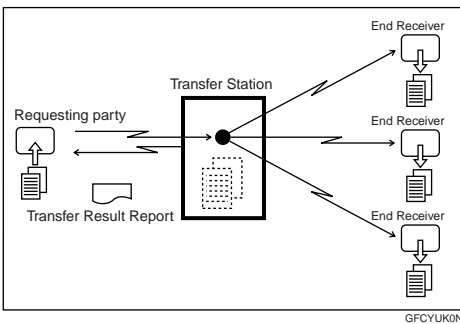

Preparation

Store the end receiver fax numbers beforehand in the transfer station's Quick Dials, Speed Dials or Groups.

The following terminology is used in this section.

❖ Requesting Party

The machine where the message originates from, i.e. the machine making a Transfer Request.

❖ Transfer Station

The machine that forwards the incoming message to another destination, i.e. the machine that receives the Transfer Request. In this section this refers to your machine.

❖ End Receiver

The final destination of the message, i.e. the machine that the Transfer Station sends to. End Receivers must be programmed into Quick Dials, Speed Dials or Groups in the Transfer Station (this machine).

💡 Limitation

- ❑ Polling ID's of the Requesting Party and Transfer Station must be identical for this feature to work.
- ❑ This machine will not receive a Transfer Request unless it has enough free memory to store two or more destinations dialed from the number keys.
- ❑ If one of the specified end receivers is not registered in the transfer station, the transfer is halted.
- ❑ If the Requesting Party specifies a Group for the End Receivers and the total number of End Receivers exceeds 250, the Transfer Station cannot transfer the message and sends a Transfer Result Report to the Requesting Party.

🔍 Reference

P.138 "Transfer Request"

❖ Multi-step Transfer

The principles of Transfer Stations can be used to build up a multi-step facsimile network where messages are passed through several Transfer Stations. By programming the end receivers in a Transfer Station Group, you can enable this machine to transfer messages onto other Transfer Stations.

For more information, contact your service representative.

This feature can only be used if the machines are made by the same maker.

Reference

P.203 "Multi-step Transfer Group settings"

❖ Sending the Transfer Result Report

This machine compares the own fax number of the Requesting Party with the Requesting Party's number programmed in a Quick Dial or Speed Dial, and if the lower five digits of the two numbers match, it sends the Transfer Result report to the Requesting Party. For example:

- Requesting Party's own dial number:
001813-11112222
- Transfer Station's Quick Dial:
03-11112222

Transfer Result Report

This reports whether transmission to the End Receivers was successful or not.

When the Transfer Station has transferred the message to all End Receivers, it sends the Transfer Result Report back to the Requesting Party. The machine prints the report if it cannot be sent back to the Requesting Party.

Preparation

You must program the fax number of the requesting party in a Quick Dial or Speed Dial in the Transfer Station.⇒ P.194 "Registering Quick Dials", ⇒ P.209 "Registering Speed Dials"

Register the fax number in advance.⇒ P.268 "Transfer Report"

Note

- ❑ By default, a portion of the document image is printed on this report. You can turn this off with the User Parameters.⇒ P.250 "Changing the User Parameters"

Remote Transfer

This feature allows same make or other make fax machines without the Transfer Request function to perform transfer requests to this machine.

Preparation

In order for this machine to be able to accept this function, you need to register the Remote ID, and the Transfer Result Report return address in the Quick Dial or Speed Dial.⇒ P.266 "Registering ID Codes", ⇒ P.194 "Registering Quick Dials", ⇒ P.209 "Registering Speed Dials"

Limitation

- ❑ The requesting party's fax machine must be able to send out a push signal.
- ❑ The remote transfer station function only works with the standard G3 line. The optional G3 Unit, G4 Unit and optional NIC FAX Kit are not supported.

Note

- ❑ You can select whether the machine accepts remote transfers or not with the User Parameters. When shipped, this feature is turned off by default.⇒ P.250 "Changing the User Parameters"

How to make a Remote Transfer Request (push signal)

This procedure describes how to make a Transfer Request to this machine from the requesting party's machine.

Note

- To cancel the operation in progress, press the **【#】** key twice.

1 Set your document and adjust any scan settings as necessary.

2 Dial using On Hook Dial, or lift the handset and dial.

3 When the connected line is a dial line, the machine switches over so it can send a push signal.

4 When you hear the "peeee-pee-yo-ro-ro-ro" tone, press the **【#】** key.

When the remote transfer is accepted, you will hear a confirmation "peeee" tone.

Note

- If remote transfer is turned off on the machine at the other end, you will not hear a confirmation tone and the tone mentioned in step **4** will continue.
- If the Transfer Request is not accepted, for example if memory is full or the Remote ID has been wrongly entered 5 times, you will hear five "pee-po" tones and the line will be cut off.

5 Enter the 4-digit Remote ID stored in the transfer station, then press the **【#】** key.

If you enter the wrong ID, you will hear a "pee pee pee" tone. If this happens, try again.

Important

- If you do not carry out steps **5** - **10** within 30 seconds, the line will be cut off.
- Enter the next tone within 5 seconds. If you wait too long, you will hear a "pee pee pee" tone and you must start the whole procedure again.
- If you enter the wrong Remote ID 5 times, the line will be automatically cut off, and if you do not change this machine's Remote ID, remote transfer will not be accepted. The figure of 5 carries over from previous non-valid attempts.

Note

- When you enter the correct ID, you will hear a "peeee" tone.

6 Press **【2】【4】【#】**.

7 Press the **【*】** key 3 times. Specify the Transfer Result Report return address stored in the transfer station using the procedure below, then press the **【#】** key.

If the return address is correct, you will hear a "peeee" tone.

Note

- If you hear a "pee pee pee" tone, press the **【*】** key 3 times and enter the return address again.
- If you keep on getting the error tone, the return address may not be registered in the Quick Dial or Speed Dial you are specifying.

When the Return Address is Stored in a Quick Dial

- ① Enter the number (01-64) of the Quick Dial.
-

When the Return Address is Stored in a Speed Dial

- ① Press the **[*]** key, then enter the Speed Dial code (00-99).
- ⑧ Specify the end receiver then press the **[#]** key.

If the end receiver is correct, you will hear a "peeee" tone.

 **Note**

- Specify an end receiver that has been stored in a Quick Dial, Speed Dial or Group.
 - If you hear a "pee pee pee pee" tone, specify the end receiver again.
 - If you keep on getting the error tone, the end receiver may not be registered in the Quick Dial or Speed Dial you are specifying.
-

Specifying the End Receiver with a Quick Dial

- ① Enter the number (01-64) of the Quick Dial.
-

Specifying the End Receiver with a Speed Dial

- ① Press the **[*]** key, then enter the Speed Dial code (00-99).
-

Specifying the End Receiver with a Group

- ① Press the **[*]** key twice, then enter the Group number (01-09).

- ⑨ Repeat step ⑧ for all end receivers.

 **Note**

- If you specify 30 end receivers, the Transfer Request is accepted and you will hear a "pee pee pee pee" tone. In this case, proceed to step ⑩.

- ⑩ Press the **[#]** key twice.

- ⑪ When you hear the "peeee-pee-yo-ro-ro-ro" tone again, press the **[Start]** key.

Your document will be sent.

Remote Transfer with UUI

This function requires the optional G4 unit.

It allows G4 faxes with the UUI feature to make Transfer Requests to this machine using UUI instead of a push signal.

 **Preparation**

You need to store the Tone (UUI) function in a User Function key beforehand. ⇒ P.225 "Assigning User Function Keys"

 **Limitation**

- You can specify up to 30 end receivers with UUI.

 **Note**

- You can select whether or not the machine accepts remote transfers or not with the User Parameters. When shipped, this feature is turned off by default.⇒ P.250 “Changing the User Parameters”

How to make a Remote Transfer Request (UUI)

This procedure describes how to make a Transfer Request to this machine from the requesting party's machine.

1 Set your document and adjust any scan settings as necessary.

2 Select G4 then enter the fax number of the transfer station.

3 Specify the UUI.

 **Note**

- E.g. on machines of this type, press the **[User Function]** key assigned to Tone (UUI) then enter the UUI.

4 Press the **[Start]** key.

Remote Transfer Example Input

- Destination (Transfer Station) telephone number = 061234567
 - Remote ID = 7777
 - Transfer Request Result Report return address = Speed Dial 01
 - End Receivers = Quick Dial 02, Speed Dial 03, Group 04
- 061234567 • [#] 7777 [#] 24
 [#] [*] [*] [*] [*] 01 [#] 02
 [#] [*] 03 [#] [*] [*] 04
 [#] [#] [#]
 (entering the underlined parts as the UUI)

 **Note**

- You can specify a maximum of 30 end receivers.

ID Reception

If you wish to limit reception of messages to those from machines of the same make and with the same Polling ID, contact your service representative to turn this feature on.

JBIG Reception

The optional JBIG Unit or optional G3 Unit is required to use this function.

Use this feature to receive messages sent to you using the high compression protocol known as JBIG.

Authorized Reception

This feature helps you to reject junk mail. It lets you specify which terminals you wish to receive fax messages from; the others will be shut out. This is useful if you are very annoyed with someone.

To use this feature, turn Authorized Reception on and register the Specified Senders.⇒ P.278 “Authorized Reception”

Specified Tray

This function requires the optional Paper Supply Unit.

If you store the fax numbers of other fax machines from which you often receive messages, you can have messages from these senders treated differently. The numbers you store are referred to in this manual as Specified Senders.

This function lets you have messages from Specified Senders, or messages from all senders other than Specified Senders, printed out on paper from a different paper tray/unit.

For example, imagine you have yellow paper loaded in the main paper tray and white paper loaded in the optional paper supply unit. You can specify that incoming messages from Specified Senders are printed on yellow paper, and all other messages printed on white paper so you can easily distinguish between them.

To use this feature, first turn on Specified Tray, then store the Specified Senders.⇒ P.281 “*Specified Tray*”

Forwarding

Using the feature, you can select messages from Specified Senders to be printed on your machine and then sent on to another fax machine.

This is useful if, for example, you are visiting another office and would like a copy of your messages sent to that office so you can read them.

In this section, the machines that messages are forwarded to are referred to as Forwarding Stations. The locations from which you would like messages forwarded from are referred to as Specific Senders.

To use this feature, first turn on Forwarding, then store the Specified Senders.⇒ P.284 “*Forwarding*”

Printing Functions

Checkered Mark

By default, a checkered mark is printed on the first page of fax messages to help you separate them.

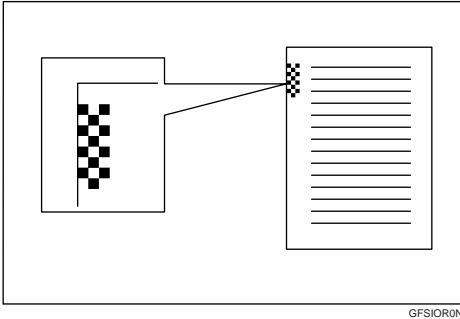

Note

- You can turn this feature off.⇒ P.250 "Changing the User Parameters"

Center Mark

By default, marks are printed halfway the left side and at the top center of each page received. This makes it easy for you to position a hole puncher correctly when you file received messages.

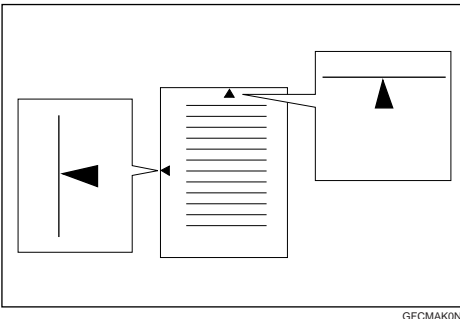

Note

- You can turn this feature on or off.⇒ P.250 "Changing the User Parameters"
- The center mark may deviate a little from the exact center of the edge.

Reception Time

You can have the date and time when a message was received printed at the bottom of the received image. This feature is turned off by default—turn it on with the User Parameters.⇒ P.250 "Changing the User Parameters"

Limitation

- When a received message is printed on two or more sheets, the date and time is printed on the last page.

Note

- The date and time printed on messages received using Memory Reception is the date and time when printed.

Collate

If you switch this feature on, multiple copies of each incoming fax message will be printed. You can also choose to have multiple copies made of messages from particular senders.

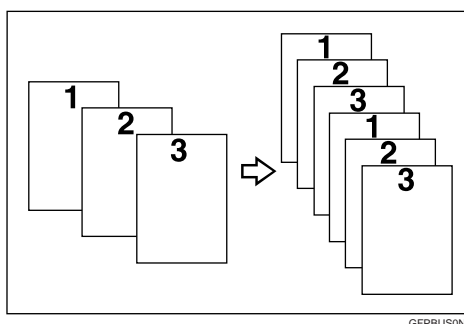

GFPBUSON

! Limitation

- The maximum number of copies that can be made of each message is 9. If you are using Collate with Specified Senders, the maximum number is 9.
- Only one set of prints is made when using the following features:
 - Confidential Reception
 - Memory Lock Reception
 - Polling Reception

📝 Note

- By default this feature is turned off. Switch it on and set the number of copies with the Collate.⇒ P.276 "Collate"
- Note that the machine will use Memory Reception for Collate.

Two In One

When two messages of the same size and direction are received consecutively, they are printed on a single sheet when you turn this feature on. This can help you economize on paper.

- Two A5 K messages are printed side by side on a sheet of A4 L .
- Two A4 K messages are printed side by side on a sheet of A3 L .

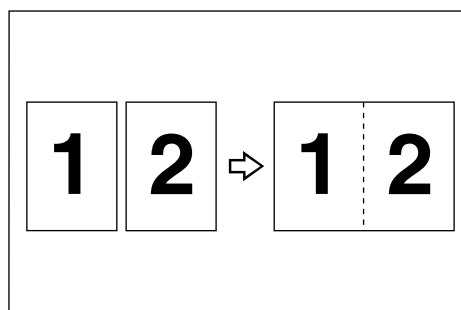

GFSYUION

! Limitation

- This feature does not work with messages larger than A4 , or LT . When LT size paper is loaded in the machine, each page of the received message is output on a single sheet.
- If paper matching the size and direction of a received document is not available, Two In One is not possible.
- This feature is not available with Polling Reception or when copying.
- If the sent pages are of different width, or were sent with different scan settings, this feature is not available.

Note

- By default this feature is turned off. Switch it on with the User Parameters.⇒ P.250 “Changing the User Parameters”
- This feature uses Memory Reception.

Image Rotation

If you have installed paper in the cassette sideways , incoming fax messages will be rotated automatically to fit on the paper.

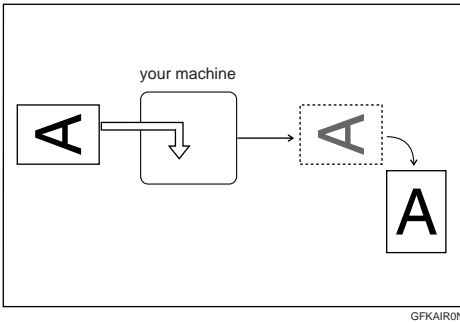

Limitation

- This feature is not available with Polling Reception.

Note

- You can choose to have received messages printed from the a specified tray.⇒ P.281 “Specified Tray”
- By default this feature is turned off. Switch it on with the User Parameters.⇒ P.250 “Changing the User Parameters”
- This feature uses Memory Reception.

Rotate Sort

When both A4 and A4 copy paper is loaded, A4 size incoming faxes are delivered alternating by message between and directions.

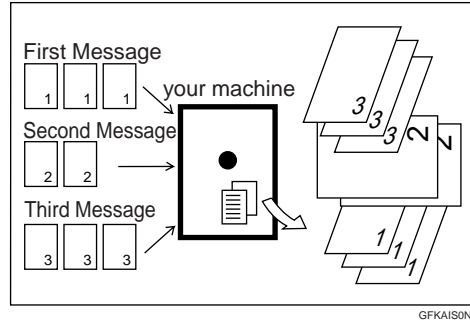

Rotate Sort is available with the following functions:

- Memory Reception
- Substitute Reception
- Confidential Reception
- Memory Lock Reception
- Lists and Reports

Limitation

- This feature is not available with Polling Reception.
- If the Specified Tray function is turned on, output may not alternate between and .
- Two In One output is not available.
- If the incoming message is wider than A4 width and neither A4 or A4 paper is loaded, this feature is not available.
- When A3 or B4 paper is loaded, if you receive long documents of A4 width, they are printed on A3 or B4 size paper.
- When Low Power Standby mode is exited, the machine may not use A4 .

Note

- When the machine is shipped, this feature is turned off by default. Turn it on or off with the User Parameters.⇒ P.250 “*Changing the User Parameters*”

Page Separation and Length Reduction (Not Available in Some Countries)

When the size of a received message is longer than the paper loaded in the machine, each page of the message can be split and printed on several sheets, or reduced and printed on a single sheet. For example, when A4 paper is loaded, this feature splits the received message if the excess length is about 20mm or more, and reduces it if the excess length is within about 20mm. When a message is split, the split mark (*) is inserted at the split position and about 10mm of the split area is duplicated on the top of the second sheet.

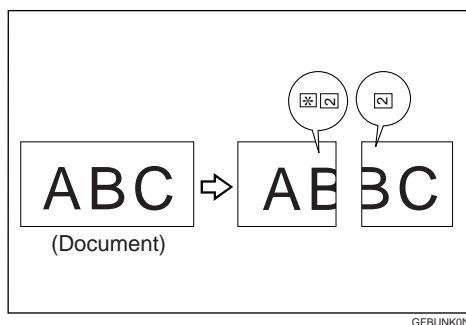
**Note**

- Your service representative can customize this feature with the following settings. Bracketed values are defaults.
 - Reduction (on)
 - Print split mark (on)
 - Overprinting (on)

- Overprinting length (10mm)
- Guideline for split (when message is 20mm longer than paper)
- You can adjust the overprinting length and length of reduction within the following ranges:
 - Guideline for split: 0 – 155mm

TSI Print

Usually the sender's TTI is printed on received messages. If the sender has not programmed their TTI, you will not be able to identify them. However, if you turn this feature on, the sender's RTI (⇒ P.35) or CSI (⇒ P.259) is printed instead so you can find out where the message came from.

Note

- When the machine is shipped, this feature is turned off by default. Turn it on or off with the User Parameters.⇒ P.250 “*Changing the User Parameters*”

CIL/TID Print

The optional G4 Unit is required to use this function.

Two features are provided for identification of messages received by G4 (ISDN). If turned on, this information will be printed on every page. Turn CIL and TID on and off with the User Parameters.⇒ P.250 “*Changing the User Parameters*”

The CIL (Call Identification Line) refers to the combination of the receiver's own fax number, name, the sender's own fax number and name, time, and page number. The default setting is on. The TID refers to the name registered by the sender in their TTI. The default setting is off.

 **Limitation**







- This feature is available only when receiving in G4 mode.

 **Note**

- You can turn CIL/TID on or off with the User Parameters.



When there is No Paper of the Correct Size

3

If there is no paper in your machine that matches the size of a received message, the machine will choose a paper size based upon the paper you have available. For example, if your machine has B4  and A5  installed and you receive an A4  size message, check the A4 column of the table below. The paper size at the top has the highest priority. In this case, since B4  is higher priority than A5 , the message is printed on B4 .

 **Priority Table**

Page Reduction	Disabled
Reduction in Sub-scan Direction	Enabled
Page Separation Threshold	20 mm
Width or Length Priority	Width

-   and   indicate that the message is split over two pages of paper with the orientation and size shown.

 **Limitation**

- Paper placed in the bypass tray is not usually selected for printing a received message.
- The paper size used to print a received message may be different from the size of the sent document.

 **Note**

- Widths that this machine can receive are A4, B4, A3 and LT. Any messages narrower than A4 or LT are sent as A4 or LT width with the length unchanged.

4. Advanced Transmission Features

Overview

Overview

This feature describes various options that you can choose when sending a fax message. The selections you make will only apply to the current fax message.

Send Later

Using this feature, you can instruct the machine to delay transmission of your fax message until a later time which you specify. This allows you to take advantage of off-peak telephone charges without having to be by the machine at the time.

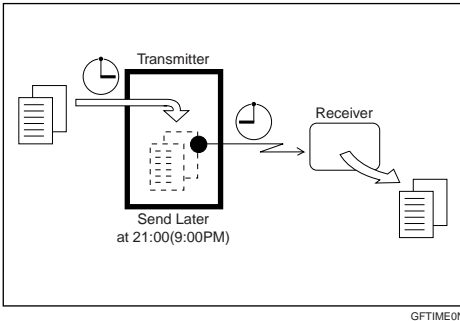

For ease of use, you can program the time when your phone charges become cheaper as the Economy Transmission time. => P.247 "Registering the Economy Transmission Time"

Then if you have a non urgent fax, just select Send Later with Economy Transmission when you scan it in. Faxes will be queued in memory and will start being sent at Economy Transmission time.

Note

- You can not specify a time more than 24 hours into the future.
- If you wish to use Economy Transmission, program the time when your phone charges get cheaper. => P.247 "Registering the Economy Transmission Time"
- This feature is only available with Memory Transmission.

1 Set your document and select any scan settings you require.

2 Press [Mode].

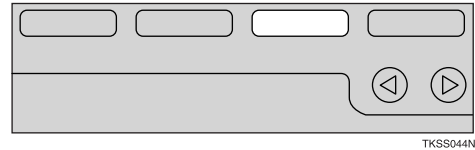
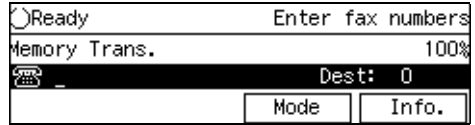

The "Transmission Mode" menu appears.

3 Enter the code for "Send Later" with number keys.

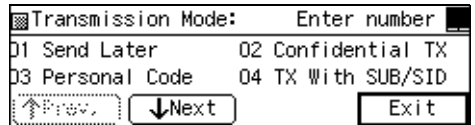

4 Enter the time with the number keys, or press [Economy TX].

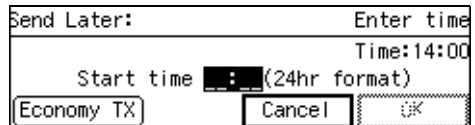

Note

- If the current time shown on the display is not correct, adjust it. => P.33 "Date/Time"
- When entering numbers smaller than 10, add a leading zero.
- If you make a mistake, press the [Clear] key or [Stop] key and try again. The [Clear] key deletes one character at a time, and the [Stop] key deletes the whole line.

- To cancel Send Later, press **[Cancel]** and the display will return to the Transmission Mode menu.

5 Press **[OK]**.

The “Transmission Mode” menu is shown on the display. A check mark is added to Send Later.

6 Press **[Exit]**.

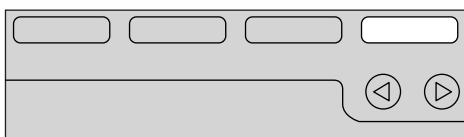
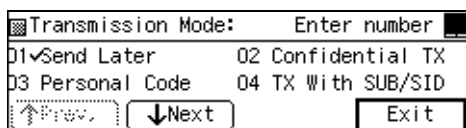

TKSS045N

The standby display is shown.

Note

- “Send Later” is shown on the display. If you set up another advanced transmission function (except Polling Reception), “Others” is displayed.

7 Dial and press the **[Start]** key.

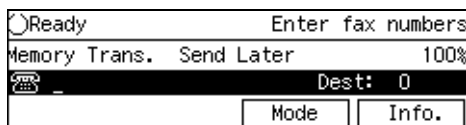

Note

- You can cancel transmission of a message set up for Send Later. ⇒ P.143 “Canceling a Transmission”

Confidential Transmission

If you do not want your message to be picked up casually at the other end, use this feature. The message will be stored in memory at the other end and will not be printed until an ID is entered.

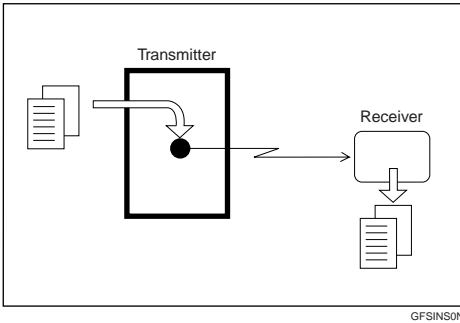

There are two types of Confidential Transmission:

❖ **Default ID**

The other party can print the message by entering the Confidential ID programmed in their machine.

❖ **ID Override**

Should you wish to send a confidential message to a particular person at the other end, you can specify the Confidential ID that person has to enter to see that message. Before you send the message, don't forget to tell the intended receiver the ID that must be entered to print it.

💡 **Limitation**

- ❑ The destination machine must be of the same make and have the Confidential Reception feature.
- ❑ The destination machine must have enough memory available.

Note

- ❑ We recommend that you program the Confidential ID beforehand.
- ❑ An ID can be any 4 digit number except 0000.

1 Set your document and select any scan settings you require.

2 Press [Mode].

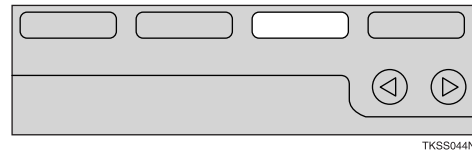
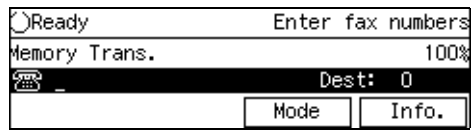

The “Transmission Mode” menu appears.

3 Enter the code for “Confidential TX” with the number keys.

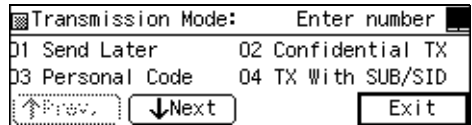

4 Depending on the Confidential Transmission type, use one of the following procedures:

Default ID

1 Press the ⏪ or ⏩ keys to turn Default ID on and press [OK].

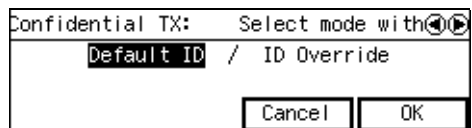



The Transmission Mode menu is shown again. A check mark is added to Confidential TX.

 **Note**

- To cancel the Confidential Transmission, press **[Cancel]**. The “Transmission Mode” menu is shown on the display.

Override ID

- 1** Press the  or  keys to turn **Override ID** on.

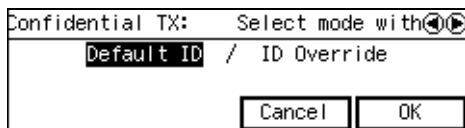

- 2** Enter the Confidential ID (4-digit number) with the number keys and press **[OK]**.

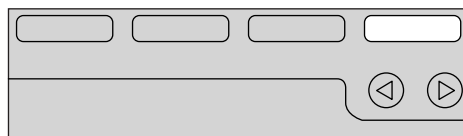
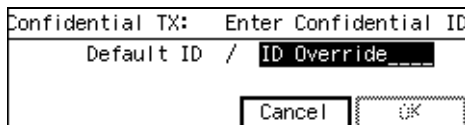

TKSS045N

The “Transmission Mode” menu is shown again. A check mark is added to Confidential TX.

 **Note**

- To Cancel the Confidential Transmission, press **[Cancel]**. The “Transmission Mode” menu is shown on the display.

- 5** Press **[Exit]**.

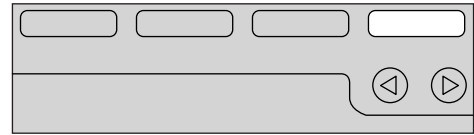
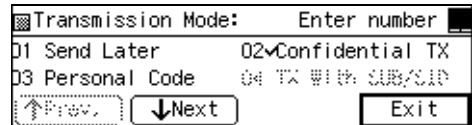

TKSS045N

The standby display is shown.

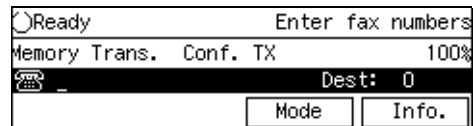

4

 **Note**

- “Conf. TX” is shown on the display. If you set up another advanced transmission function (except Polling Reception), “Others” is displayed.

- 6** Dial and press the **[Start]** key.

 **Note**

- You can cancel transmission of a message set up for Confidential Transmission. ⇒ P.143 “Canceling a Transmission”

Personal Code Transmission

Personal Codes allow you keep track of machine usage. If everybody uses a Personal Code when they use the fax machine, the codes or the names programmed for the codes will be printed in the Journal(⇒ P.156) and other reports. This will help you to check up on who has been using the machine and how often.

4 **Preparation**

To register Personal Codes, create a Personal Box for each user beforehand. The SUB code you specify will become the user's Personal Code.

1 Set your document and select any scan settings you require.

2 Press [Mode].

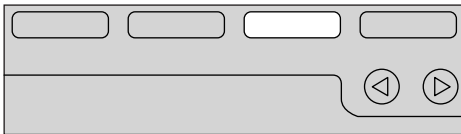
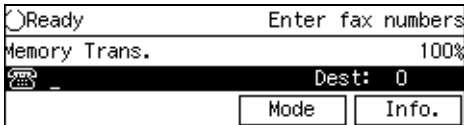

TKSS044N

The “Transmission Mode” menu appears.

3 Enter the code for “Personal Code” with the number keys.

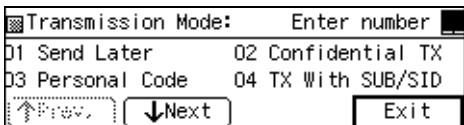

4 Enter a Personal Code/SUB Code (up to 20 digits) with the number keys.

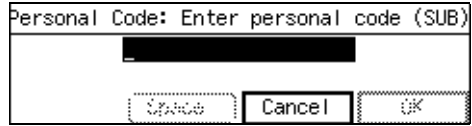

Note

- If a Personal Code is programmed with a name, it is shown below the Personal Code on the display.
- If you make a mistake, press the [Clear] key or [Stop] key and try again. The [Clear] key deletes one character at a time, and the [Stop] key deletes the whole line.
- To cancel the Personal Code Transmission, press [Cancel]. The “Transmission Mode” menu is shown on the display.

To enter a Personal Code with a Quick Dial key

1 Press the Quick Dial key the Personal Code has been assigned to.

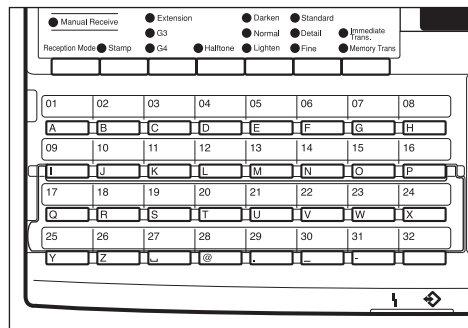

TKSS050N

2 Press [Yes].

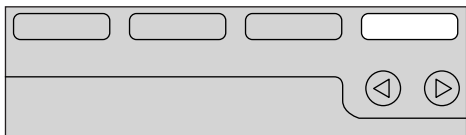
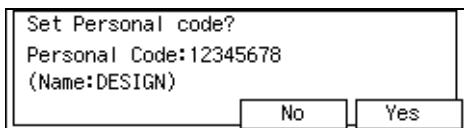

TKSS045N

Proceed to step **6**.

5 Press [OK].

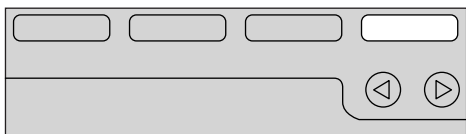
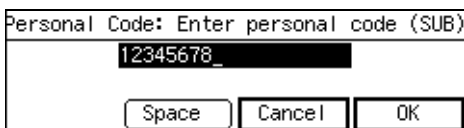

TKSS045N

The “Transmission Mode” menu is shown again. A check mark is added to “Personal Code”.

6 Press [Exit].

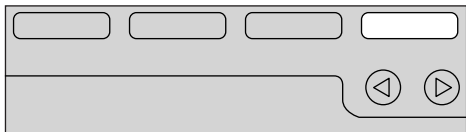
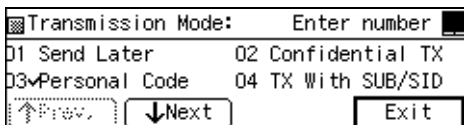

TKSS045N

The Personal Code screen appears.

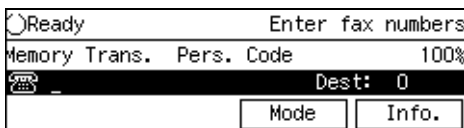

Note

- “Pers. Code” is shown on the display. If you set up another advanced transmission function (except Polling Reception), “Others” is displayed.

7 Dial and press the [Start] key.

Note

- You can cancel transmission of a message set up for Personal Transmission. ⇒ P.143 “Canceling a Transmission”

Entering a Personal Code with a Quick Dial Key

When a SUB Code (Personal Code) for a Personal Box has been assigned to a Quick Dial key, you can perform Personal Code Transmission by just pressing that key.

Reference

P.304 “Registering/Editing Personal Boxes”

1 Set your document and select any scan settings you require.

2 Press the Quick Dial key the Personal Code has been assigned to.

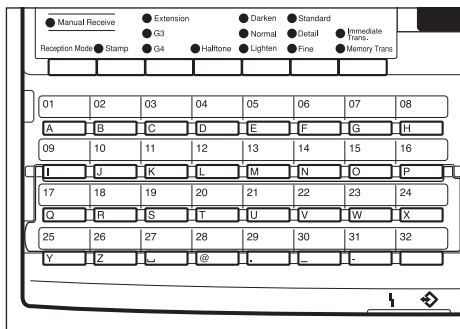

TKSS050N

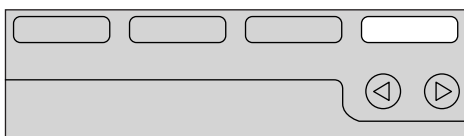
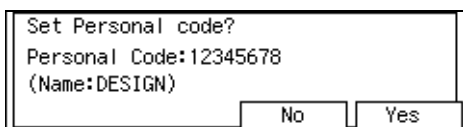
3 Press [Yes].

TKSS045N

The Personal Code screen appears.

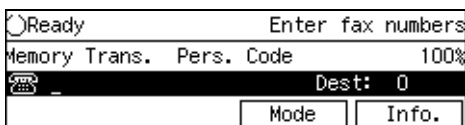

4

Note

- “Pers. Code” is shown on the display. If you set up another advanced transmission function (except Polling Reception), “Others” is displayed.

4 Dial and press the [Start] key.**Note**

- You can cancel transmission of a message set up for Personal Transmission.⇒ P.143 “Canceling a Transmission”

SUB Code Transmission with the Mode Key

Confidential Transmission is only possible with machines of the same make that have the Confidential Transmission feature. However, if you use the SUB/SID function, you can send and receive confidential faxes to and from other makers' machines that have the SUB/SID feature.

1 Set your document and adjust any scan settings as necessary.

2 Press [Mode].

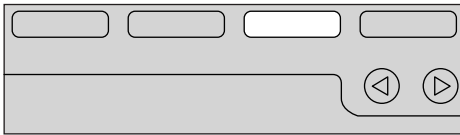
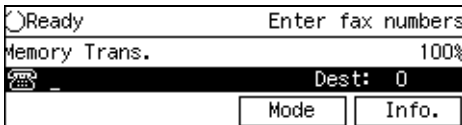

TKSS044N

The “Transmission Mode” menu appears.

3 Enter the code for “TX With SUB/SID” with the number keys.

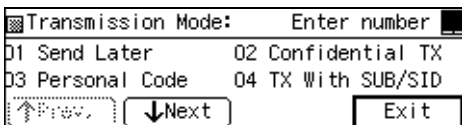

Note

- If the item you require is not displayed, press [**↑Prev.**] or [**↓Next**] until it is.

4 Check the display message, then press [OK].

A check mark appears next to “TX With SUB/SID”.

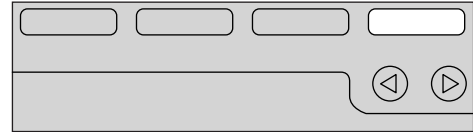
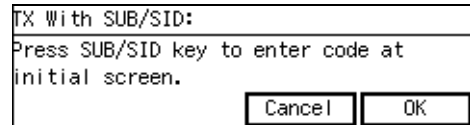

TKSS045N

5 Press [Exit].

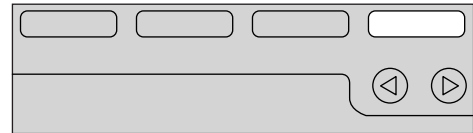
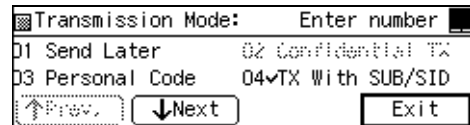

TKSS045N

Note

- SUB/SID is displayed. However, if other settings under the Mode menu other than Polling Reception are selected, the others is displayed.

6 Dial the destination fax number.

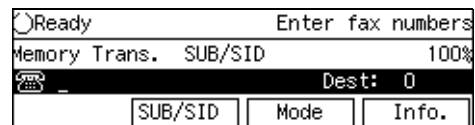

Note

- If you make a mistake, press the [**Clear**] key or [**Stop**] key and try again. The [**Clear**] key deletes one character at a time, and the [**Stop**] key deletes the whole line.

Reference

- P.81 "Number Keys"
- P.88 "Dialing with Quick Dials"
- P.88 "Dialing with Speed Dials"

7 Press [SUB/SID].

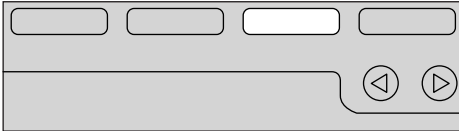
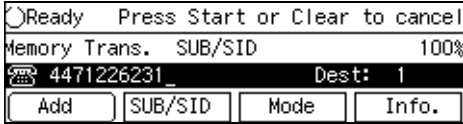

TKSS044N

8 Enter the SUB code.

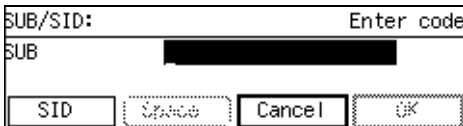

Note

- You can enter up to 20 characters.
- You can enter digits 0-9, #, * and spaces. To enter a space, press **[Space]** (the first character cannot be a space).
- If you make a mistake, press the **[Clear]** key or **[Stop]** key and try again. The **[Clear]** key deletes one character at a time, and the **[Stop]** key deletes the whole line.

When entering the SID (Password) is necessary

1 Press [SID].



TKSS042N

2 Enter the SID code.

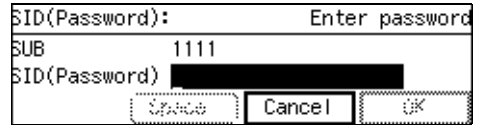

Note

- You can enter up to 20 characters.
- You can enter digits 0-9, #, * and spaces. To enter a space, press **[Space]** (the first character cannot be a space).
- If you make a mistake, press the **[Clear]** key or **[Stop]** key and try again. The **[Clear]** key deletes one character at a time, and the **[Stop]** key deletes the whole line.

3 Press [OK].

9 Press [OK].

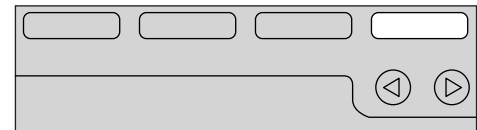
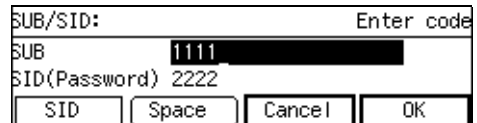

TKSS045N

If you wish to specify another destination

1 Press [Add].

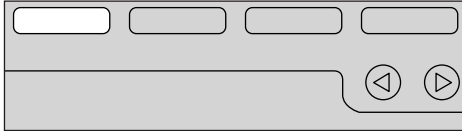
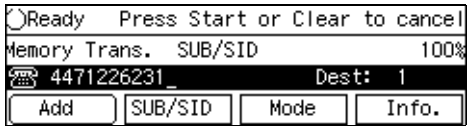

TKSS042N

2 Repeat steps 6-9.

10 Press the [Start] key.

Note

- You can cancel transmission of a message set up for SUB Code Transmission. ⇒ P.143 "Canceling a Transmission"

SEP Code Polling Reception

If you wish receive a message stored in the memory of another party's fax machine, use this feature. The machine will receive the message with the SEP and PWD code that matches the SEP and PWD code you enter in the procedure below.

1 Press [Mode].

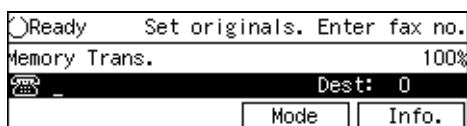

The "Transmission Mode" menu appears.

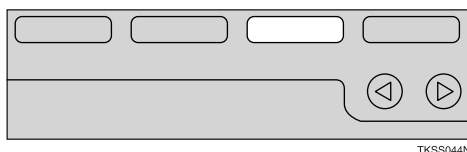

2 Enter the code for "RX WITH SEP/PWD" with the number keys.

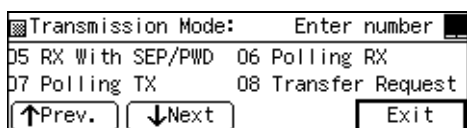

Note

- ❑ If the item you require is not displayed, press [**↑Prev.**] or [**↓Next**] until it is.

3 Check the display message, then press [OK].

A check mark appears next to "RX WITH SEP/PWD".

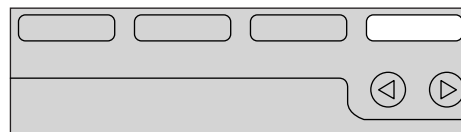
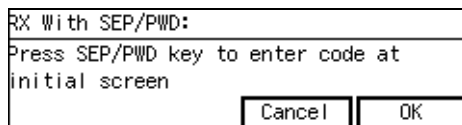

4 Press [Exit].

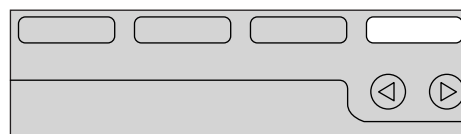
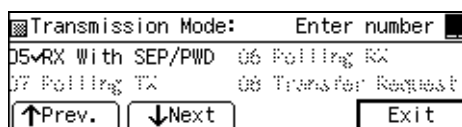

5 Dial the destination fax number.

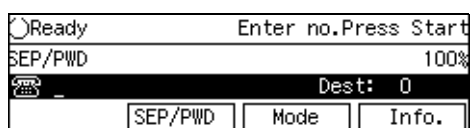

Note

- ❑ If you make a mistake, press the [**Clear**] key or [**Stop**] key and try again. The [**Clear**] key deletes one character at a time, and the [**Stop**] key deletes the whole line.

Reference

P.81 "Number Keys"

P.88 "Dialing with Quick Dials"

P.88 "Dialing with Speed Dials"

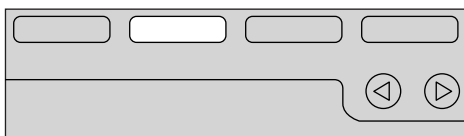
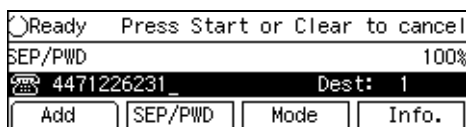
6 Press [SEP/PWD].

TKSS043N

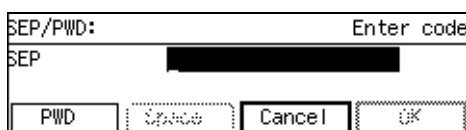
7 Enter the SEP code.**Note**

- You can enter up to 20 characters.
- You can enter digits 0-9, #, * and spaces. To enter a space, press [Space] (the first character cannot be a space).
- If you make a mistake, press the [Clear] key or [Stop] key and try again. The [Clear] key deletes one character at a time, and the [Stop] key deletes the whole line.

When entering the PWD (Password) is necessary

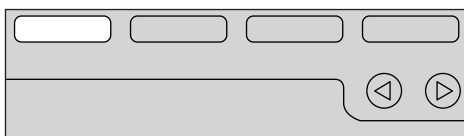
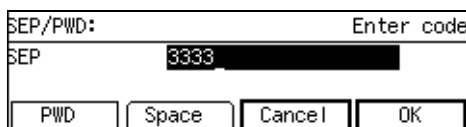
1 Press [P.W.D.].

TKSS042N

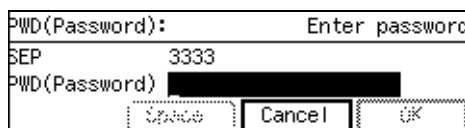
2 Enter the PWD code.**Note**

- You can enter up to 20 characters.
- You can enter digits 0-9, #, * and spaces. To enter a space, press [Space] (the first character cannot be a space).
- If you make a mistake, press the [Clear] key or [Stop] key and try again. The [Clear] key deletes one character at a time, and the [Stop] key deletes the whole line.

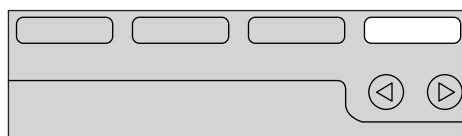
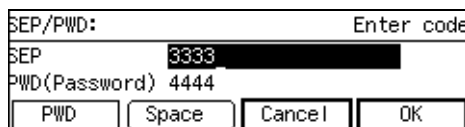
3 Press [OK].**8** Press [OK].

TKSS045N

If you wish to specify another destination

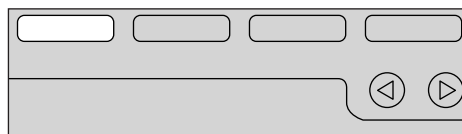
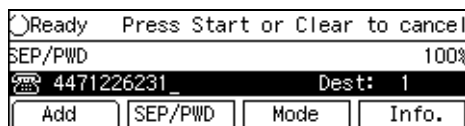
1 Press [Add].

TKSS042N

② Repeat steps ⑤-⑧.

⑨ Press the **[Start]** key.

 **Note**

- You can cancel SUB Code Reception.⇒ P.143 *“Canceling a Transmission”*

Polling Reception

Use this function if you want to poll a message from another terminal. You can also poll documents from many terminals with only one operation (use Groups and Keystroke programs to fully exploit this feature).

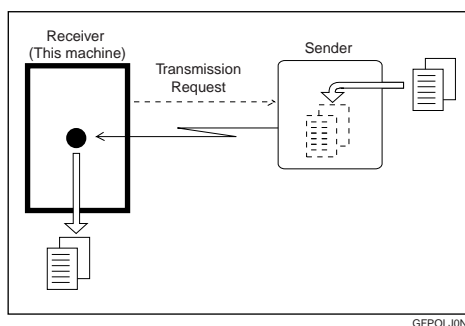

There are two types of Polling Reception.

❖ Default ID Polling Reception (Free Polling Reception)

Use this method for Free Polling or Default ID Polling. If the Polling ID is programmed in your machine, any messages waiting in the transmitting machine with the same ID are received. If the other machine does not have any messages waiting with the same Polling ID, any messages that do not require ID are received (Free Polling).

❖ Override ID Polling Reception

You must enter an Override Polling ID unique to this transmission. This ID overrides that stored in the Polling ID.

Your machine will receive any messages waiting in the transmitting machine with matching ID's. If no ID's match, any messages that do not require ID are received (Free Polling).

📌 Limitation

- Polling Reception requires that the other machine can perform Polling Transmission.
- To receive a message sent by any Default ID Polling Transmission or Override ID Polling Transmission, it is necessary to specify the same Polling ID as the sender's.
- To receive a message sent by Default ID Polling Transmission or Override ID Polling Transmission, the sender must use a machine of the same make that has polling capability. With Free Polling Reception, a message can be also received from other manufacturer's machines as long as they have polling capability.

📌 Note

- A Polling ID may be any four numbers (0 to 9) and characters (A to F) except 0000 and FFFF.
- A total of up to 250 files for varying ID's can be stored.
- Polling Documents from Other Manufacturers' Fax Machines Standard Polling Reception only works with machines of the same make that have the Polling Reception feature. However, if the other party's fax machine supports SEP Transmission, you can receive documents from them using SUB/SEP Reception.

1 Press [Mode].

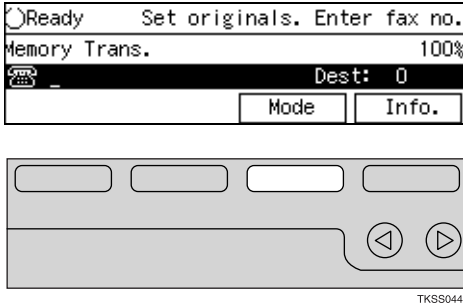

The “Transmission Mode” menu appears.

2 Enter the code for “Polling RX” with the number keys.

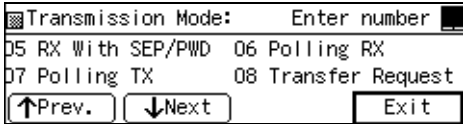

Note
 If the appropriate display is not shown, press [↑Prev.] or [↓Next].

3 Depending which method you are using, choose one of the following procedures:

Default ID Polling Reception

1 Press the [Left] or [Right] key to select “Default ID”.

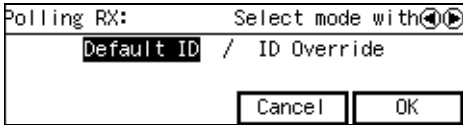

ID Override Polling Reception

1 Press the [Left] or [Right] key to select “Override ID”.

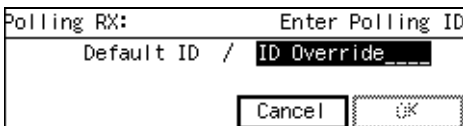

2 Enter a Polling ID (4 characters) with the number keys and Quick Dial keys A-F.

Note
 If you make a mistake, press the [Clear] key or [Stop] key and try again. The [Clear] key deletes one character at a time, and the [Stop] key deletes the whole line.
 Codes 0000 and FFFF are not available.

4 Press [OK].

The “Transmission Mode” menu is shown. A check mark is added to Polling Reception.

Note
 To cancel Polling Reception, press [Cancel]. “The Transmission Mode” menu is shown.

5 Press [Exit].

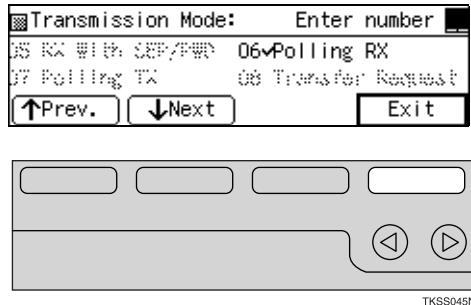

The following display is shown.

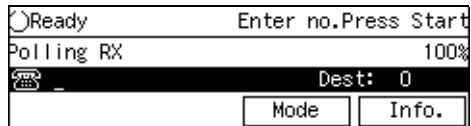

Note
 “Polling RX” is displayed.

6 Dial and press the [Start] key.

 **Note**

- You can cancel Polling Reception.⇒ P.143 *“Canceling a Transmission”*

File Reserve Report (Polling Reception)

This report is printed after Polling Reception has been set up.

 **Note**

- By default this report is turned off. Turn it on with the User Parameters.⇒ P.250 *“Changing the User Parameters”*

Communication Result Report (Polling Reception)

This report is printed after a Polling Reception has been completed and shows the result of the Polling Reception.

 **Note**

- You can also check the result of a Polling Reception with the Journal.
- By default this report is turned on. Turn it on with the User Parameters.⇒ P.250 *“Changing the User Parameters”*

Polling Transmission

Use Polling Transmission when you want to leave a document in the machine's memory for others to pick up. The message will be sent when the other party calls you up.

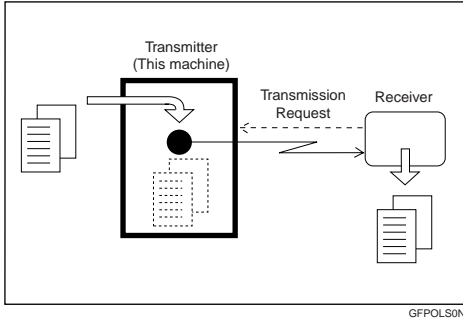

There are three types of Polling Transmission.

Preparation

Before using Polling Reception you must store the Polling ID in your machine beforehand.

❖ Default ID Polling Transmission

The message will only be sent if the Polling ID of the machine trying to poll your message is the same as the Polling ID stored in your machine. Make sure that both machines' Polling IDs are identical in advance.

❖ Free Polling Transmission

Anybody can poll the message from your machine. The machine sends it regardless of whether Polling ID's match.

❖ Override ID Polling Transmission

You must enter an Override Polling ID unique to this transmission. This ID overrides that stored in the Polling ID. The user must supply this ID when they poll your machine and if the IDs match, the message is sent. Make sure the other end knows the ID you are using in advance.

💡 Limitation

- Polling Transmission is allowed only if the receiver's machine has the Polling Reception feature. With Free Polling, a message can also be sent to other manufacturer's machines as long as they have the Polling Reception feature. With Default ID and Override ID Polling Transmission, a document can be sent only to a the machine of the same make with the Polling Reception feature.
- Free Polling and Default ID Polling Transmission allow only one file to be stored in memory. Override ID Polling Transmission allows a file to be stored in memory for each ID; a total of up to 250 files for varying ID's can be stored.
- Before using "Default ID Polling" and "Override ID Polling", you need to program the Polling ID.
- A Polling ID may be any string of four numbers (0 to 9) and characters (A to F) except 0000 and FFFF.

Note

- The communication fee is charged to the receiver.

- Polling Transmission to Other Manufacturer's Fax Machines. Standard Polling Transmission only works with machines of the same make that have the Polling Reception feature. However, if the other party's fax machine supports SEP polling function, you can send documents to them using SUB Code Transmission. ⇒ P.125 "SUB Code Transmission with the Mode Key"

1 Set your document and select any scan settings you require.

2 Press [Mode].

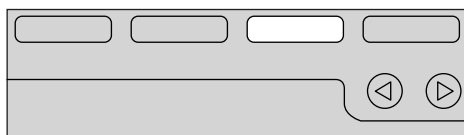
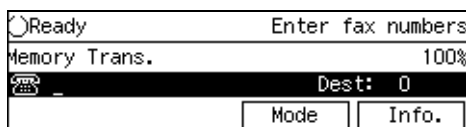

TKSS044N

The "Transmission Mode" menu appears.

3 Enter the code for "Polling TX" with the number keys.

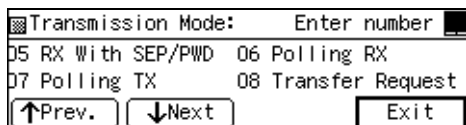

Note

- If the appropriate display is not shown, press [↑Prev.] or [↓Next].

4 Depending on the Polling Transmission type, use one of the following procedures.

Default ID Polling Transmission

1 Press the ◀ or ▶ key to select "Default ID".

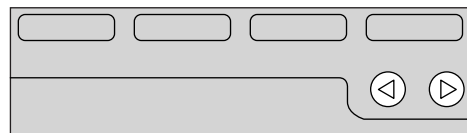
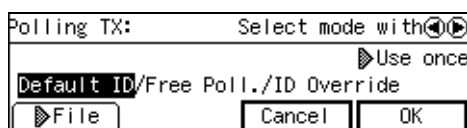

TKSS046N

2 Press [▶ File] to specify whether to save the stored document or not.

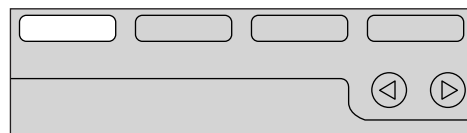
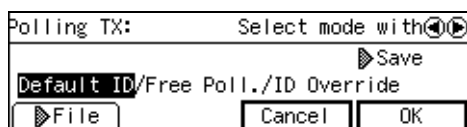

TKSS042N

Each time you press the key, the text at the middle right corner of the display toggles between "Save" and "Use once".

Note

- To delete the document immediately after transmission, select "Use once". To repeatedly send the document, select "Save".

Free Polling Transmission

1 Press the ◀ or ▶ key to select "Free Poll."

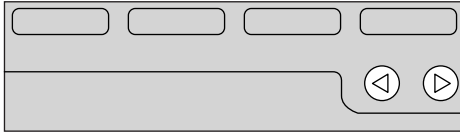
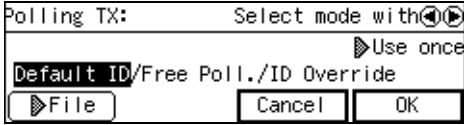

TKSS046N

2 Press [▶ File] to specify whether to save the stored document or not.

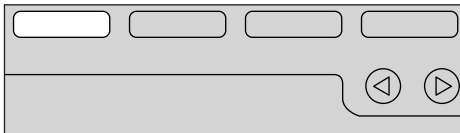
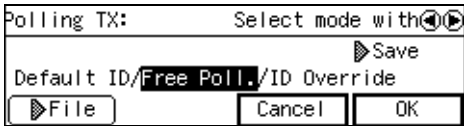

TKSS042N

Each time you press the key, the text at the middle right corner of the display toggles between "Save" and "Use once".

Note

- ❑ To delete the document immediately after transmission, select "Use once". To repeatedly send the document, select "Save".

ID Override Polling Transmission

1 Press the ◀ or ▶ key to select "ID Override".

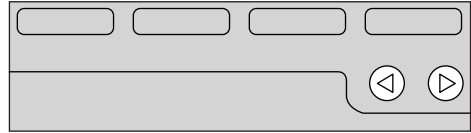
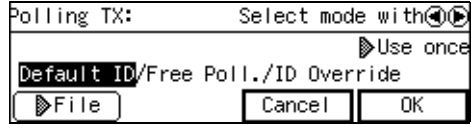

TKSS046N

2 Enter the 4 character Polling ID with the number keys and Quick Dial keys A-F.

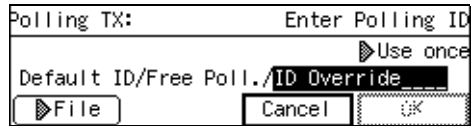

Note

- ❑ If you make a mistake, press the [Clear] key or [Stop] key and try again. The [Clear] key deletes one character at a time, and the [Stop] key deletes the whole line.
- ❑ Codes 0000 and FFFF are not available.

3 Press [▶ File] to specify whether to save the stored document.

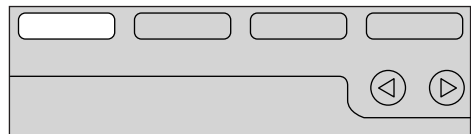
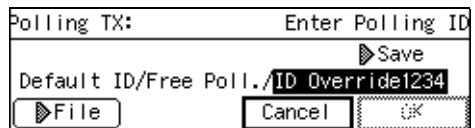

TKSS042N

Each time you press the key, the text at the middle right corner of the display toggles between “Save” and “Use once”.

 **Note**

- To delete the document immediately after transmission, select “Use once”. To repeatedly send the document, select “Save”.

5 Press [OK].

The “Transmission Mode” menu is shown. A check mark is added to “Polling TX”.

 **Note**

- To cancel the Polling Transmission, press [Cancel]. The Transmission Mode menu is shown.

6 Press [Exit].

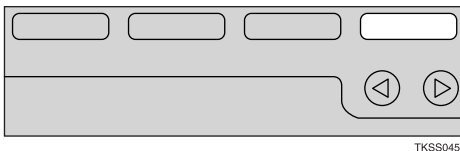
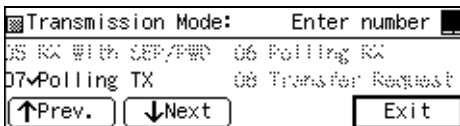

TKSS045N

The standby display is shown.

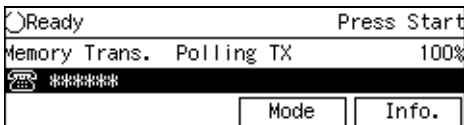

 **Note**

- “Polling TX” is displayed. If you set up other advanced transmission functions (except Polling Reception), “Others” is displayed.

7 Press the [Start] key.

 **Note**

- You can cancel transmission of a message set up for Polling Transmission.⇒ P.143 “Canceling a Transmission”

Polling Transmission Clear Report

This report allows you to verify whether Polling Transmission has taken place.

 **Limitation**

- This report is not printed if the User Parameters are set to allow the stored documents to be repeatedly sent (“Standby”).⇒ P.250 “Changing the User Parameters”

 **Note**

- This report is turned on by default. You can turn it off if you wish.⇒ P.250 “Changing the User Parameters”
- By default, a portion of the sent image is printed on the report. You can turn this off with the User Parameters.⇒ P.250 “Changing the User Parameters”
- You can also check the result of a Polling Transmission with the Journal.⇒ P.156 “Printing the Journal”

Transfer Request

Transfer Request allows fax machines that have this feature to automatically distribute incoming messages onto multiple fax destinations. This feature helps you save costs when you send the same message to more than one place in a distant area, and saves time since many messages can be sent in a single operation.

The diagram below may make the concept clearer.

4

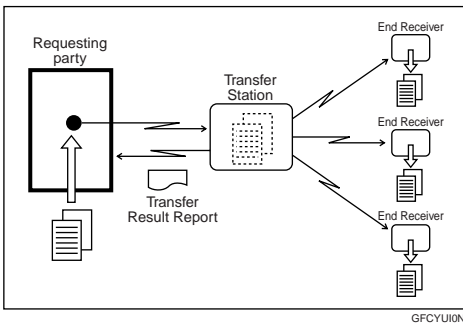

Preparation

Before you can use this feature you must program the Polling ID and your G3 Direct Number (when the optional G4 unit is installed, register the G4 Fax Number). ⇒ P.266 "Registering ID Codes", ⇒ P.268 "Transfer Report"

Polling ID's of the requesting party (this machine) and Transfer Stations must be identical.

The following terminology is used in this section.

❖ Requesting Party

The machine where the message originates from, i.e. the machine making a Transfer Request (in this section, this machine).

❖ Transfer Station

The machine that forwards the incoming message to another destination, i.e. the machine that receives the Transfer Request.

❖ End Receiver

The final destination of the message, i.e. the machine that the Transfer Station sends to. End Receivers must be programmed into Quick Dials, Speed Dials or Groups in the Transfer Station.

💡 Limitation

- The Transfer Stations you specify must be machines of the same make as this machine and have the Transfer Station function.
- You can specify up to 100 Transfer Stations in a Transfer Request.
- You can have up to 30 End Receivers per Transfer Station. If you specify a Transfer Station Group, the Group counts as a single receiver.
- The combined total of End Receivers and Transfer Stations you specify with the number keys cannot exceed 100.

1 Set a document and select any scan settings you require.

2 Press [Mode].

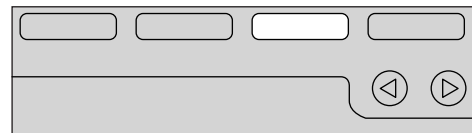
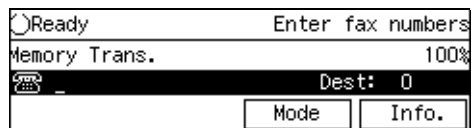

TKSS044N

The “Transmission Mode” menu appears.

- 3 Enter the code for “Transfer Request” with the number keys.

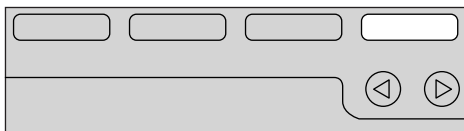

TKSS045N

Note

- If the appropriate display is not shown, press [**↑Prev.**] or [**↓Next**].

- 4 Enter a Transfer Station and press [**Recv. Stn**].

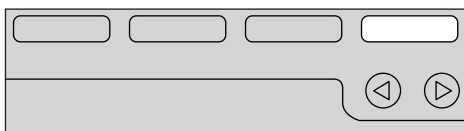

TKSS045N

Limitation

- You cannot specify a transfer station and a normal fax destination at the same time.

Note

- Enter the fax numbers of the Transfer Stations with either Quick Dials, Speed Dials or the number keys.
- If you make a mistake, press the [**Clear**] key or [**Stop**] key and try again. The [**Clear**] key deletes one character at a time, and the [**Stop**] key deletes the whole line.

- To cancel the Transfer Request, press [**Cancel**]. The “Transmission Mode” menu is shown again.

- 5 Enter one or more End Receivers.

Note

- You cannot enter the numbers of the End Receivers directly. The numbers must be stored in Quick Dials, Speed Dials or Groups in the Transfer Station(s). To specify an End Receiver, use the special format described in⇒ P.140 “*Specifying an End Receiver*”.
- Press [**Add RcvStn**] if you wish enter more End Receivers.
- Press **⏪** or **⏩** to see the End Receivers already entered. You can select an End Receiver from this list and cancel it by pressing the [**Stop**] key or [**Clear**] key.
- To cancel the Transfer Request, press [**Cancel**].

- 6 When you have specified all the End Receivers, press [**OK**].

- 7 If you want to enter an additional Transfer Station, press [**Enter**] and repeat steps 4 to 6.

If you press [**No**], the “Transmission Mode” menu is shown and a check mark is added to Transfer Request.

8 Press [Exit].

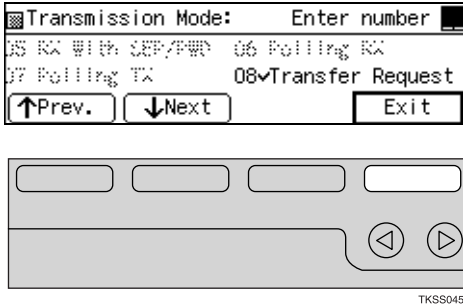

The following display is shown.

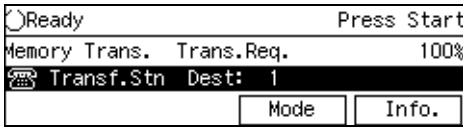

Note

- The numbers of Transfer Stations and End Receivers are displayed.

9 Press the [Start] key.

Note

- You can cancel transmission of a message set up for Transfer Request. ⇒ P.143 "Canceling a Transmission"

❖ **Quick Dial**

Enter [#] followed by the number (2 digits) of the Quick Dial where the End Receiver is stored. For example, to choose the number stored in Quick Dial 01 in the Transfer Station, enter: [#][0][1]

❖ **Speed Dial**

Enter [#], [*], [*] followed by the Speed Dial code (2 or 3 digits). For example, to choose the number stored in Speed Dial 12 in the Transfer Station, enter: [#][*][*][1][2]

❖ **Group Dial**

Enter [#], [*], [*] followed by the Group number (2 digits). For example, to choose the number stored in Group 04 in the Transfer Station, enter: [#][*][*][0][4]

Specifying an End Receiver

When you make a Transfer Request, you must specify the final destinations (End Receivers) for your message.

You cannot enter the numbers of the End Receivers directly. Instead, enter a simple code that describes where the numbers are stored in the Transfer Station (in Quick Dials, Speed Dials or Groups).

The numbers must first have been stored in Quick Dials, Speed Dials or Groups in the Transfer Station(s).

TTI Print

By default, the machine adds your TTI (Transmit Terminal Identification) to each message you send so it appears on the printed fax at the other end. You can change your TTI with the RTI/TTI.⇒ P.35 “Registering your RTI and TTI”

Important

- ❑ In the USA, this must contain the telephone number of the line your machine is connected to. It will be printed on the header of every page you send. Required in the USA.

Note

- ❑ You can switch this feature off with the User Parameters.⇒ P.250 “Changing the User Parameters”

1 Set the document and select any scan settings you require.

2 Press [Mode].

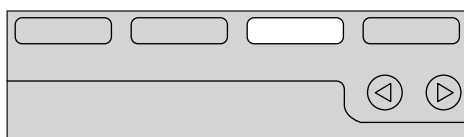
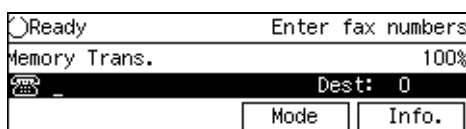

TKSS044N

The “Transmission Mode” menu appears.

3 Enter the code for “TTI Print” with the number keys.

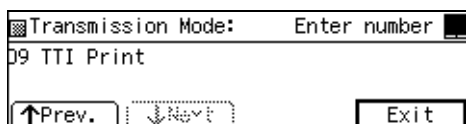

Note

- ❑ If “TTI Print” is not shown, press [↑Prev.] or [↓Next].

4 Press the ◀ or ▶ key to switch TTI Print on or off.

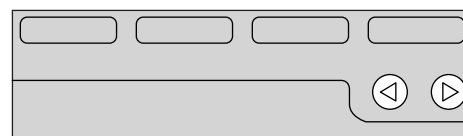
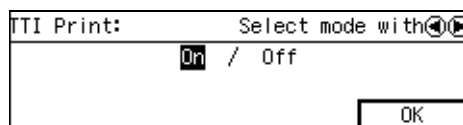

TKSS046N

Note

- ❑ The default setting is on.

5 Press [OK].

The “Transmission Mode” menu is shown. A check mark is added to options.

6 Press [Exit].

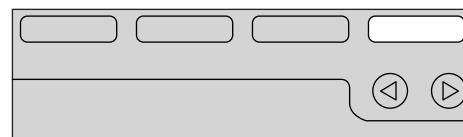
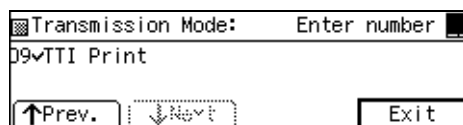

TKSS045N

The standby display is shown.

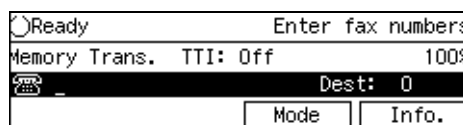

 **Note**

- ❑ “TTI: Off” is shown. If you set up another advanced transmission function (except Polling Reception), “Others” is shown.

7 Dial and press the **[Start]** key.

5. Communication Information

Checking and Canceling Transmission Files

Transmission files are documents that have been stored in memory and are awaiting transmission. The features that produce transmission files are Memory Transmission, Confidential Transmission, Transfer Request, Polling Reception and Polling Transmission. These features are described in detail elsewhere in this document.

This section describes how you can:

- Delete a file (cancel a transmission)
- Print a file ^{*1}
- Check the destination(s) and options selected
- Alter when a file will be sent
- Resend a file
- Change destinations
- Delete destinations
- Add destinations

^{*1} This does not apply to Polling Reception or Confidential Transmission.

Limitation

- If you cancel a file being sent, the communication is immediately stopped and the file is canceled. A page which has already been sent cannot be canceled.
- You cannot change the start time add/delete a destination while a file is being sent.

Canceling a Transmission

1 Press [Info.].

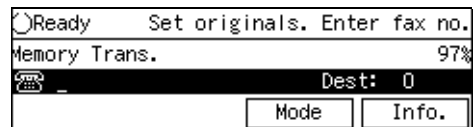

The "Information" menu is shown.

2 Enter the code for "Check/Cancel TX Files" with the number keys.

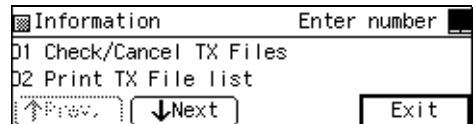

Note

- If "Check/Cancel TX Files" is not shown, press [↑Prev.] or [↓Next].

3 Press the **◀** or **▶** key until the file you want to delete is shown and press **[Delete]**.

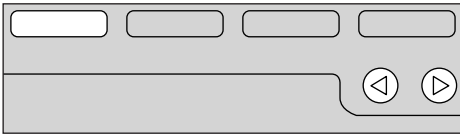
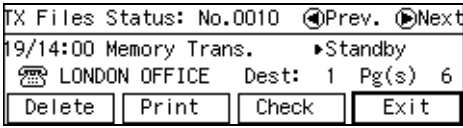

TKSS047N

4 Press **[Yes]**.

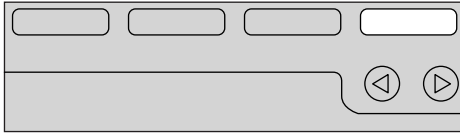
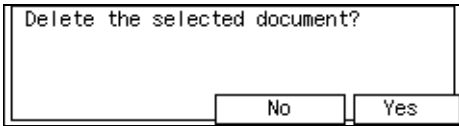

TKSS045N

The file is erased.

5 Press **[Exit]**.

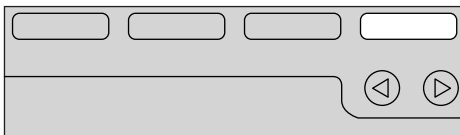
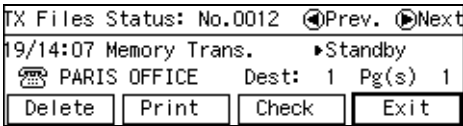

TKSS045N

Note

- To delete another file, repeat steps **3** and **4**.
- If no faxes are on transmission standby, the display in step **6**.

6 Press **[Exit]**.

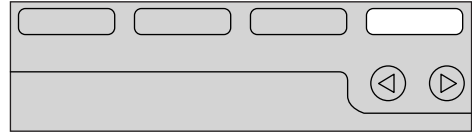
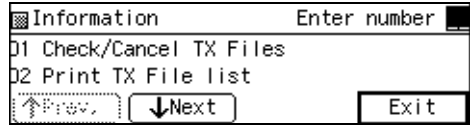

TKSS045N

The standby display is shown.

Printing a File

If you wish to check the contents of a fax that is stored in memory and has not been sent yet, use this procedure to print it out.

1 Press **[Info.]**.

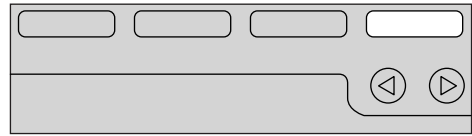
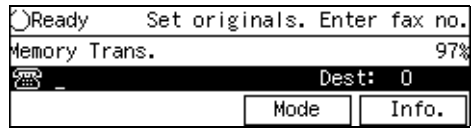

TKSS045N

The “Information” menu is shown.

2 Enter the code for “Check/Cancel TX Files” with the number keys.



Note

- If “Check/Cancel TX Files” is not shown, press **[↑Prev.]** or **[↓Next]**.

- 3** Press the **[Left]** or **[Right]** key until the file you want to print is shown and press **[Print]**.

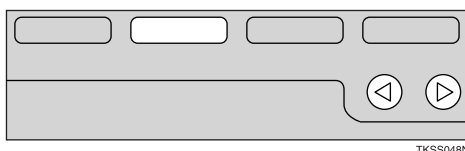
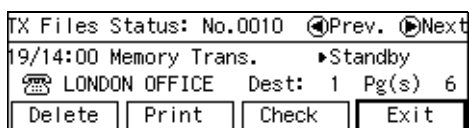

- 4** Press the **[Start]** key.

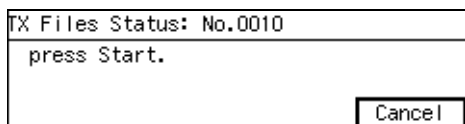

The file is printed.

Note

- Press **[Cancel]** to stop printing the file and return to the step **3** display.

- 5** Press **[Exit]**.

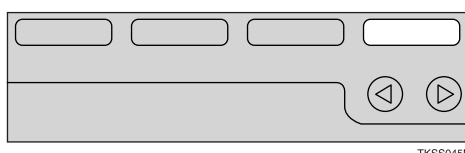
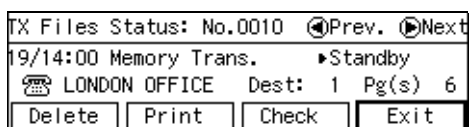

The “Information” menu is shown again.

- 6** Press **[Exit]**.

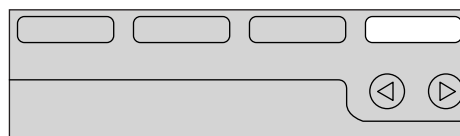
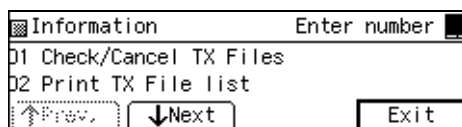

The standby display is shown.

Checking and Editing a File

Use this procedure to check or edit destination(s), check options selected or alter the transmission time.

5

- 1** Press **[Info.]**.

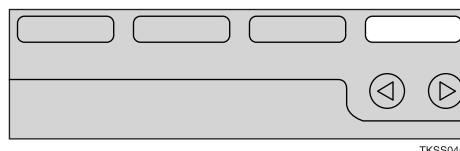
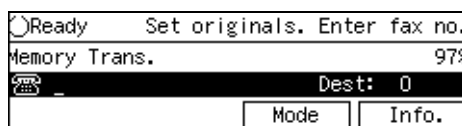

The “Information” menu is shown.

- 2** Enter the code for “Check/Cancel TX Files” with the number keys.

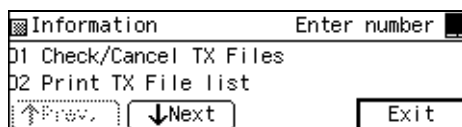

Note

- If “Check/Cancel TX Files” is not shown, press **[Up]Prev.** or **[Down]Next**.

3 Press the **⏪** or **⏩** key until the file you want to print is shown. Then press **[Check]**.

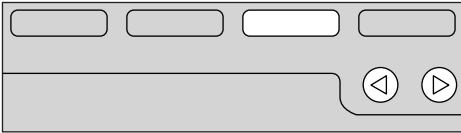
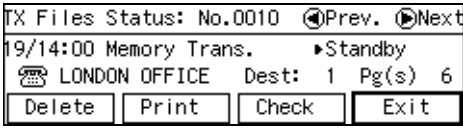

TKSS049N

4 Depending on the setting you want to check or change, use one of the following procedures.

5

Checking destinations (Destination List)

1 Enter the code for "Destination List" with the number keys.

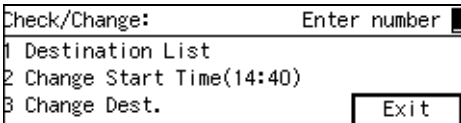

The total number of destinations and the fax number or each destination's name is shown.

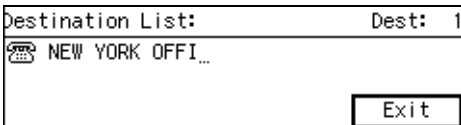

Note

- To see hidden destinations, press **[↑Prev.]** or **[↓Next]**.

Changing the transmission time

1 Enter the code for "Change Start Time" with the number keys.

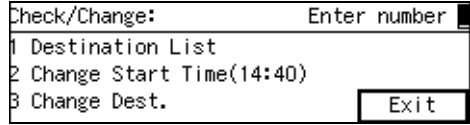

2 Enter the transmission time (4 digits) with the number keys.

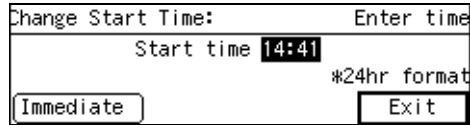

Note

- You can not specify a start time more than 24 hours into the future.
- To start transmission immediately, press **[Immediate]**. If memory contains other files queued for transmission, those files are sent first.

Re-sending a file

If you select the failed transmission file, you can resend it. This feature allows you to transmit a fax message again. You can choose to have files that were not transmitted successfully stored in memory with the File Retention feature. These files will be kept for either up to 24 or 72 hours depending on how you program File Retention feature. ⇒ P.258 "File Retention"

- 1 Enter the code for "Retransmit" with the number keys.

```

Check/Change:      Enter number
1 Destination List
2 Retransmit
3 Change Dest.      Exit
    
```

- 2 Press [Yes].

```

Resend document?
[ ] No [ ] Yes
    
```

TKS045N

Note

- If you do not want to send the file, press [No].
- 3 Enter the code for "Change Start Time" with the number keys.

- 4 Enter the start time with the number keys.

```

Change Start Time:  Enter time
Start time  :
#24hr format
Immediate      Exit
    
```

Note

- You can not specify a start time more than 24 hours into the future.
- To start transmission immediately, press [Immediate]. If memory contains other files queued for transmission, those files are sent first.

Changing a destination

You can delete or add destinations.

- 1 Enter the code for "Change Dest." with the number keys.

```

Check/Change:      Enter number
1 Destination List
2 Change Start Time(14:40)
3 Change Dest.      Exit
    
```

- 2 Change the destination.

```

Change Dest.:      Add/change destination
1/1
[01] NEW YORK OFFICE Dest: 1
Add      Exit
    
```

Note

- To cancel a destination, press the ⏪ or ⏩ key until the destination you want to cancel is shown and press the [Stop] key or [Clear] key.
- To add a destination, press [Add] and enter the fax number with the number keys. Destinations can be specified only by using the number keys. The destination is added to the end of the list.
- If you change a destination of a file that is automatically being dialed or awaiting redial, redial is canceled so you will need to resend that file.

- 5 Press [Exit].

6 Press [Exit].

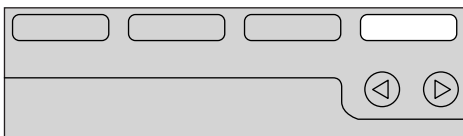
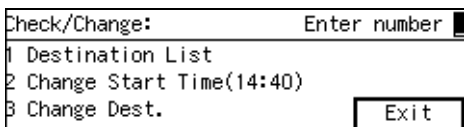

TKSS045N

7 Press [Exit].

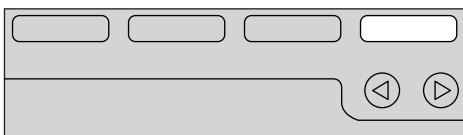
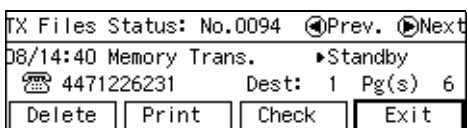

TKSS045N

The “Information” menu is shown.

8 Press [Exit].

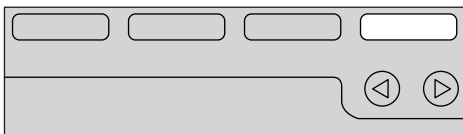
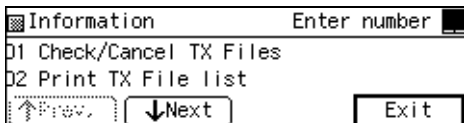

TKSS045N

The standby display is shown.

5

Printing a List of Files in Memory (Print TX File List)

Print this list if you wish to find out which files are stored in memory and what their file numbers are. Knowing the file number can be useful (e.g., when erasing files).

Note

- The contents of a document stored in memory can also be printed. ⇒ P.144 "Printing a File"

1 Press [Info.].

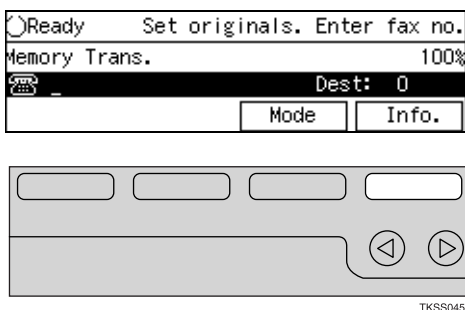

The "Information" menu is displayed.

2 Enter the code for "Print TX File list" with the number keys.

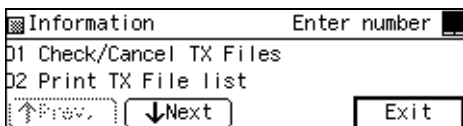

Note

- If "Print TX File list" is not shown, press [↑Prev.] or [↓Next].

3 Press the [Start] key.

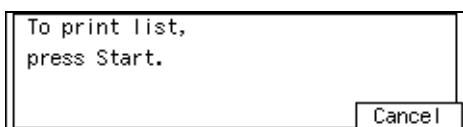

The transmission file list is printed. When the printing is completed, the "Information" menu is shown.

Note

- Press [Cancel] to stop printing the file list and return to the "Information" menu.

4 Press [Exit].

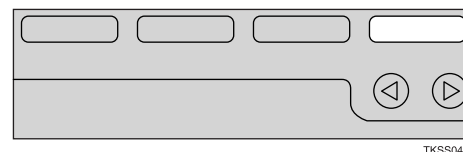
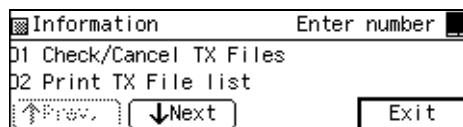

The standby display is shown.

Checking the Transmission Result (TX Status)

If you wish to find out whether a file was sent successfully, you don't have to always print the Journal. With this function you can browse through the last 250 completed transmissions on the display.

Limitation

- ❑ Only the last 250 transmissions are shown. Earlier transmissions are not available.
- ❑ If a transmission is completed while you are using this function, the result will not be shown until you exit TX Status and start it again.

Note

- ❑ When the optional Function Upgrade card is installed, you can check up to 1,000 communications.

1 Press [Info.].

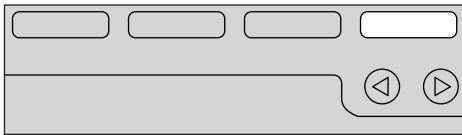
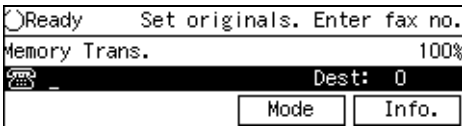

TKSS045N

The "Information" menu is shown.

2 Enter the code for "TX Status" with the number keys.

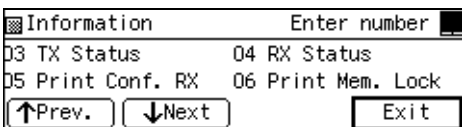

Note

- ❑ If "TX Status" is not shown, press [↑Prev.] or [↓Next].

3 Press [↑Prev.] or [↓Next] to scroll through the list.



The results are shown two at a time with the most recent above.

4 Press [OK].

The standby display is shown.

5 Press [Exit].

Checking the Reception Result (RX Status)

This function lets you check up on the last 250 messages received without having to print the Journal. You can browse through the received messages on the display.

Limitation

- ❑ Only the last 250 messages are displayed. Earlier messages are not available.
- ❑ If a message is received while you are using this function, the result will not be shown until you exit RX File Status and start it again.

Note

- ❑ When the optional Function Upgrade card is installed, you can check up to 1,000 communications.

1 Press [Info.].

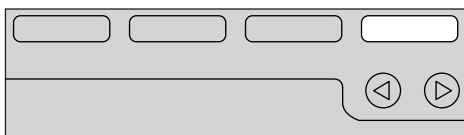
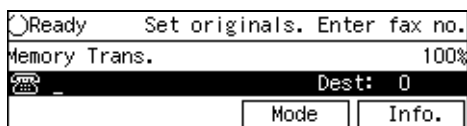

TKSS045N

The "Information" menu is shown.

2 Enter the code for "RX Status" with the number keys.

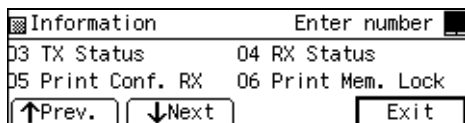

Note

- ❑ If "RX Status" is not shown, press [Prev.] or [Next].

3 Press [Prev.] or [Next] to scroll through the messages.

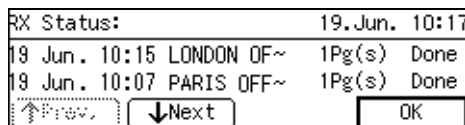

The results are shown two at a time with the most recent above.

4 Press [OK].

The standby display is shown.

5 Press [Exit].

Printing a Confidential Message

This feature is designed to prevent messages being picked up casually by anyone when they are received. If someone sends you a message using Confidential Transmission, it is stored in memory and not automatically printed. To print the message you have to enter the Confidential ID code. When your machine has received a confidential message, the  indicator lights.

Preparation

Before using this function, program your Confidential ID. ⇒ P.266 "Registering ID Codes"

Important

- If the Main Power switch is off more than an hour, all Confidential Messages are deleted. In such a case, use the Power Failure Report to identify which messages have been lost. ⇒ P.192 "When Power is Turned Off or Fails"

Limitation

- You must program the Confidential ID for Confidential Reception to work.

- 1** Make sure that the  indicator is lighting.

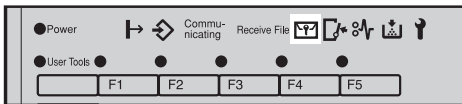

- 2** Press [Info.].



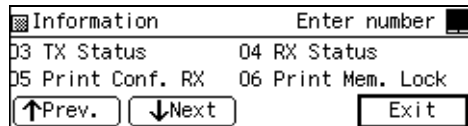

The "Information" menu is shown.

- 3** Enter the code for "Print Conf. RX" with the number keys.



Note

- If "Print Conf. RX" is not shown, press [Prev.] or [Next].

- 4** Enter the Confidential ID (4-digit number) with the number keys.

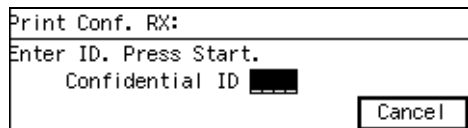

Note

- If you receive a fax by Confidential ID Override Reception, enter the override Confidential ID.
- You need to obtain the override Confidential ID from the sender.

- 5** Press the [Start] key.

The received messages are printed. When printing has finished, the "Information" menu is shown.

Note

- ❑ If no Confidential Messages have been received, the message “No matching file found.” is shown. Press **[OK]**.
- ❑ If the Confidential IDs or Personal Confidential IDs do not match, the message “No matching file found.” is displayed. Press **[OK]** to cancel the operation, check the Confidential ID or Personal Confidential ID with the other party and try again.

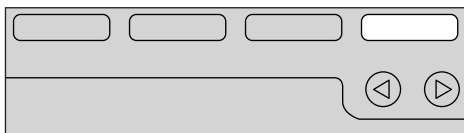
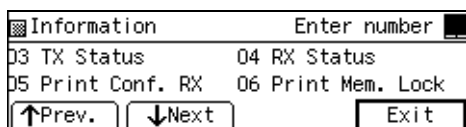
6 Press **[Exit]**.

TKSS045N

The standby display is shown.

Confidential File Report

By default, this report is printed whenever your machine receives a Confidential Message.

Note

- ❑ You can turn this report off with the User Parameters.⇒ P.250 “Changing the User Parameters”

Printing a File Received with Memory Lock

This is a security feature designed to prevent unauthorized users from reading your messages. If Memory Lock is switched on, all received messages are stored in memory and are not automatically printed. To print the messages, you have to enter the Memory Lock ID code. When your machine has received a message with Memory Lock, the  indicator blinks.

Preparation

Before you start, program your Memory Lock ID.⇒ P.266 “Registering ID Codes”

Note

- Messages received by Polling Reception are automatically printed even if this feature is switched on.
- If the Main Power Switch is turned off for more than an hour, all messages protected by Memory Lock will be deleted. In such a case, the Power Failure Report will be printed so you can confirm which messages have been lost.⇒ P.192 “When Power is Turned Off or Fails”
- Memory Lock is switched off by default. Turn it on with the User Tools.⇒ P.292 “Memory Lock”
- You can also apply Memory Lock to messages that come only from certain senders.⇒ P.292 “Memory Lock”

1 Make sure that the  indicator is flashing. Press [Info].

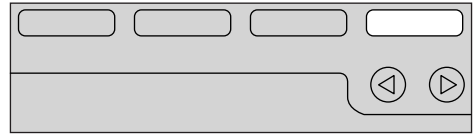
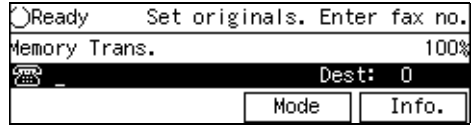

TKSS045N

The "Information" menu is shown.

2 Enter the code for “Print Mem. Lock” with the number keys.

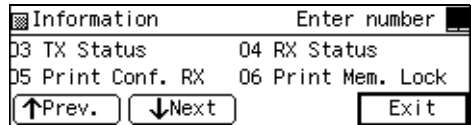

Note

- If “Print Mem. Lock” is not shown on the display, press [↑Prev.] or [↓Next].

3 Enter the Memory Lock ID (4-digit number).

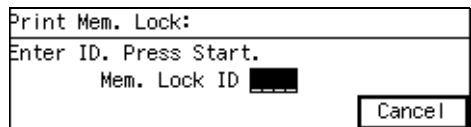

4 Press the [Start] key.

The received messages are printed. When the printing is completed, the "Information" menu is shown.

Note

- If no messages have been received, the following message will appear. “No matching file found.” Press [OK].

- ❑ If the Memory Lock IDs do not match, the following message will appear: “No matching file found.”. Press **[OK]** and retry after checking the Memory Lock ID.

5 Press **[Exit]**.

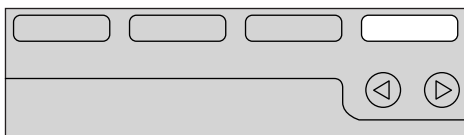
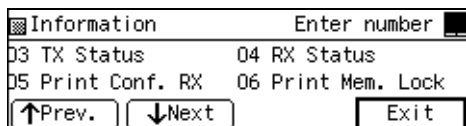

TKS045N

The standby display is shown.

Printing the Journal

The Journal contains information about the last 250 communications made by your machine. By default, it is printed automatically after every 50 communications (receptions + transmissions).

You can also print a copy of the Journal at any time by following the procedure below.

Note

- The sender's name column of the Journal is useful when you need to register a Specified Sender.
- If you do not want the Journal printed, you can turn it off. ⇒ P.250 "Changing the User Parameters"
- When the optional Function Upgrade Card is installed, you can check up to 1,000 communications.

1 Press [Info.].

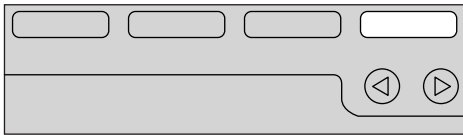
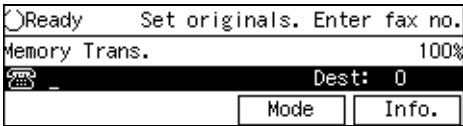

TKSS045N

The "Information" menu is shown.

2 Enter the code for "Print Journal" with the number keys.

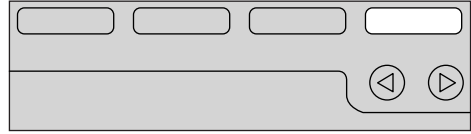
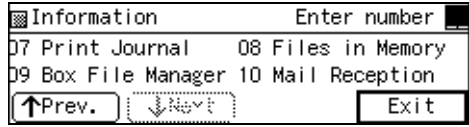

TKSS045N

Note

- If "Print Journal" is not shown, press [↑Prev.] or [↓Next].

3 Press the ◀ or ▶ key to select the format you require.

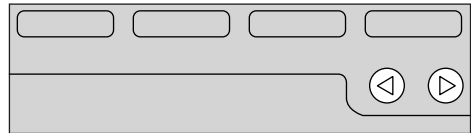
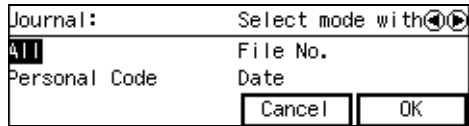

TKSS046N

When choosing "All"

1 Press [OK].

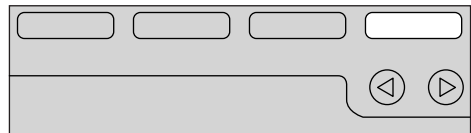
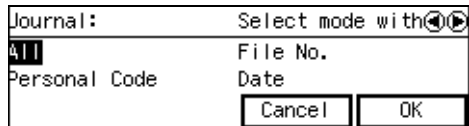

TKSS045N

When choosing "File No."

- 1 Press [OK].

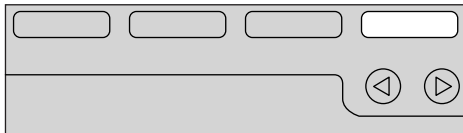
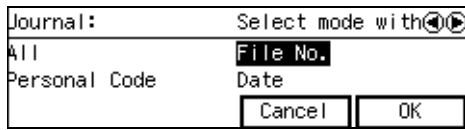

TKSS045N

- 2 Enter a 4-digit file number with the number keys.

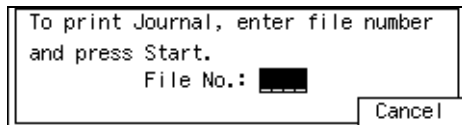

When choosing "Date"

- 1 Press [OK].

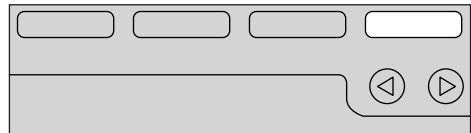
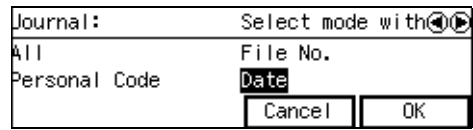

TKSS045N

- 2 Enter the day with the number keys.

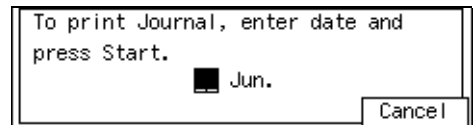

When choosing "Personal Code"

- 1 Press [OK].

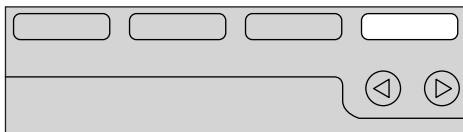
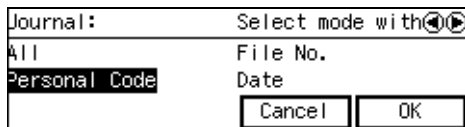

TKSS045N

- 2 Enter a Personal Code (up to 20 digits) with the number keys.

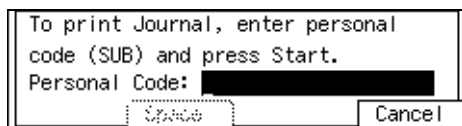

- 3 Press the [Right] key, then choose the month with [UpMonth] or [DownMonth].

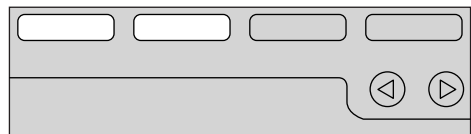

TKSS045N

- 4 Press the [Start] key.
The Journal is printed.

Note

- Press [Cancel] to return to the "Information" menu.

5 Press [Exit].

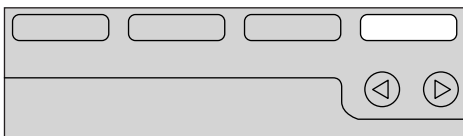
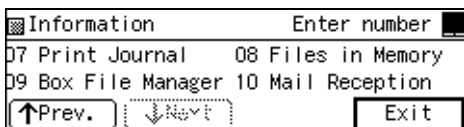

TKSS045N

The standby display is shown.

Displaying the Files in Memory

Use this function to display a summary of current memory usage. Items shown are the percentage of free memory space, the number of received confidential messages, the number of files to be sent, and the number of received messages to be printed.

1 Press [Info.].

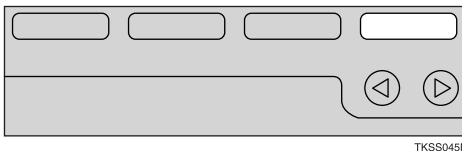
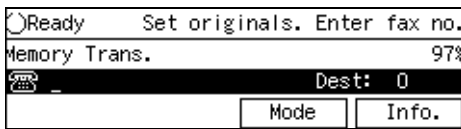

TKSS045N

The "Information" menu is shown.

2 Enter the code for "Files in Memory" with the number keys.

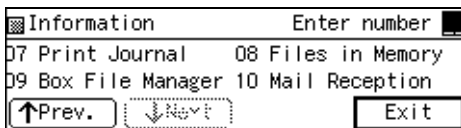

Note

□ If "Files in Memory" is not shown, press [↑Prev.] or [↓Next].

3 The usage is displayed. When you have finished, press [OK].

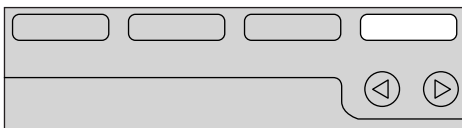
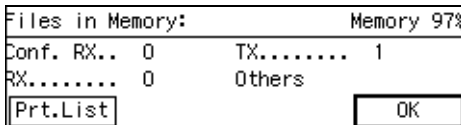

TKSS045N

Note

- "Others" is displayed for the following kinds of files:
 - Auto Documents(⇒ P.218)
 - Incoming messages sent with the Transfer Request feature(⇒ P.138)
 - Messages that have been received into Transfer Boxes(⇒ P.43)

To print the transmission file list

1 Press [Prt. List].

2 Press the [Start] key.

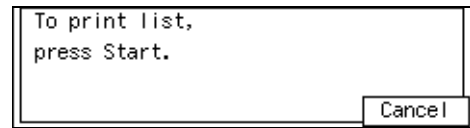

Note

□ Press [Cancel] to stop printing the Transmission File List and return to step **3**.

4 Press [Exit].

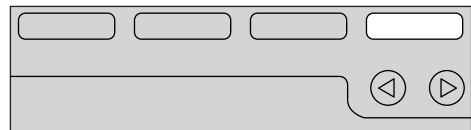
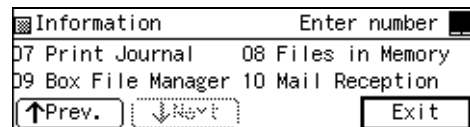

TKSS045N

The standby display is shown.

TX/RX File Save

This feature requires the optional Function Upgrade Card and optional 40M Expanded Memory Card.

When the TX/RX File In HD feature is turned on, you can print out sent or received documents that are stored in memory.

The following functions are available with TX/RX File Save:

- Search TX File⇒ P.161
Search memory for sent faxes
- Search RX File⇒ P.163
Search memory for received faxes
- Disk File Search List/Visual List⇒ P.166
Print either of these lists for a hard copy of the search results generated by the Search TX File and Search RX File functions.
- Print File⇒ P.166
Print out faxes stored in memory
- Delete File⇒ P.167
Delete faxes stored in memory

Preparation

These features require that the TX/RX File In HD feature is turned on. When the machine is shipped, this feature is turned off by default. For how to turn it on, see P.295 "TX/RX File In HD".

Important

- If a TX/RX file is saved in memory, it does not guarantee that the communication was successful. Messages that were not delivered or generated an error are also stored.

Limitation

- If the "Memory Reception if no RTI or TTI received" settings in the User Parameters is set to "Not Possible" and neither the CSI nor RTI is stored in the other party's fax machine, the TX/RX file feature can not be used. Set "Memory Reception if no RTI or TTI received" to "Possible" or request the other party to store their RTI/CSI.
- When free memory goes below 50%, the oldest stored message is erased.

Note

- You can have this feature used only for messages received from Specified Senders.⇒ P.295 "TX/RX File In HD"
- By default, both transmissions and receptions are stored. Your service representative can change this to one of the following options:
 - Transmissions Only
 - Receptions Only

Searching Memory for Sent Faxes

1 Press [Info.].

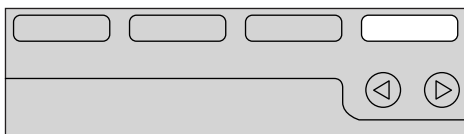
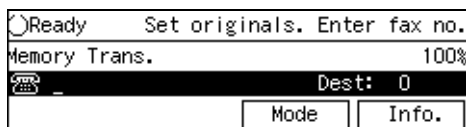

TKSS045N

2 Enter the code for "TX/RX File Save" with the number keys.

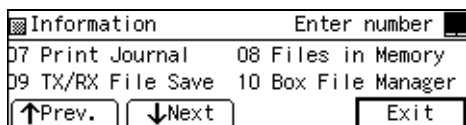

Note

- If the item you require is not displayed, press [**↑Prev.**] or [**↓Next**] until it is.

3 Enter the code for "Search TX File" with the number keys.

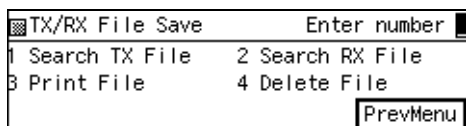

4 Press [Search].

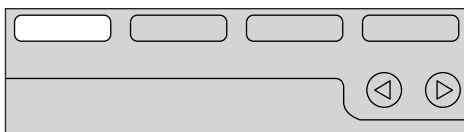
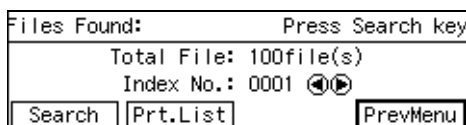

TKSS042N

Note

- To print a list off all files, press [**Prt. List**].

5 Enter the code of the search method you require.

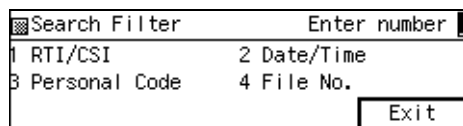

6 Do one of the following:

Searching By RTI/CSI

1 Enter the RTI or CSI using the Quick Dials or number keys.

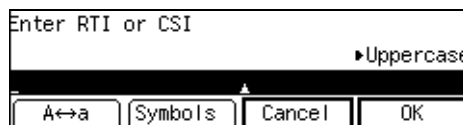

Note

- Press [**A↔a**] to switch between upper and lower case.
- Press [**Symbols**] if you wish to enter symbols.

2 Press [OK].

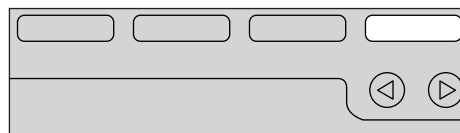
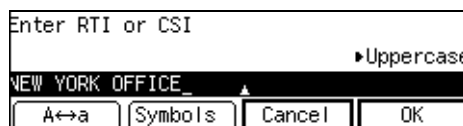

TKSS045N

Note

- If you press [**Cancel**], the machine returns to the display in step 5.

Searching By Date/Time

- 1 Enter the day with the number keys. Choose the month with [↑Month] or [↓Month]. Press the [▶] key, then enter the year and time with the number keys.

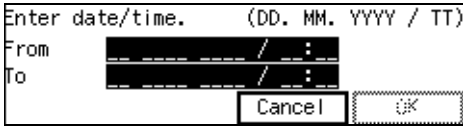

- 2 Press [OK].

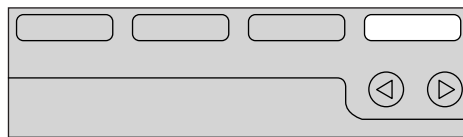
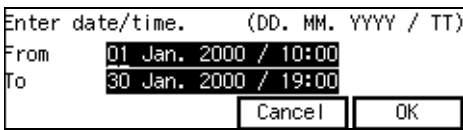

TKSS045N

Note

- If you press [Cancel], the machine returns to the display in step 5.

Searching By Personal Code (SUB Code)

- 1 Enter the Personal Code/SUB Code (up to 20 digits) with the number keys.

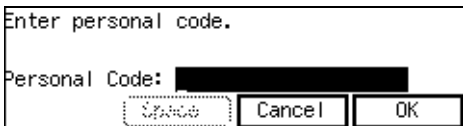

- 2 Press [OK].

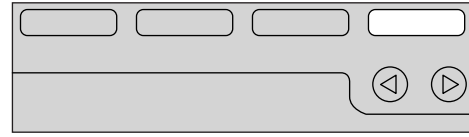
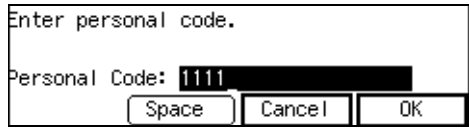

TKSS045N

Reference

P.122 "Personal Code Transmission".

Note

- If you press [Cancel], the machine returns to the display in step 5.

Searching By File Number

- 1 Enter the file number (4 digits) with the number keys.

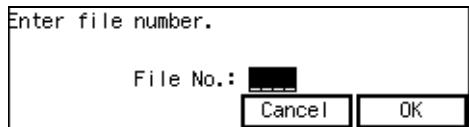

- 2 Press [OK].

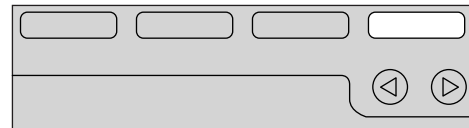
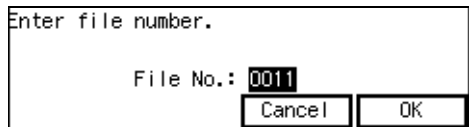

TKSS045N

Note

- If you press [Cancel], the machine returns to the display in step 5.

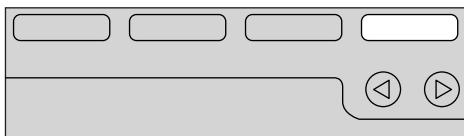
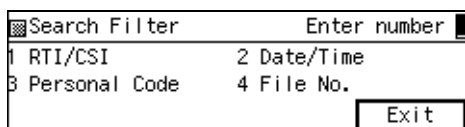
7 Press [Exit].

TKSS045N

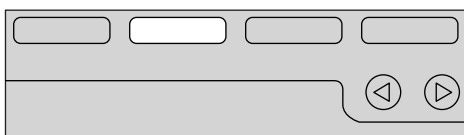
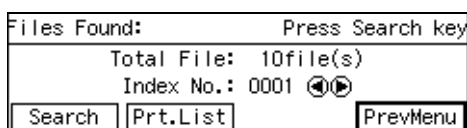
8 Press [Prt. List].

TKSS043N

Note

- If you want to do a fresh search, press [Search] and return to step **5**.
- Press ⏪ or ⏩ to check through the file numbers of the search results.

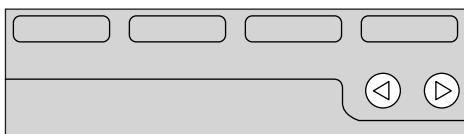
9 Press ⏪ or ⏩ to choose whether the image is printed on the list.

TKSS046N

Note

- To cancel this operation, press [Cancel]. The display in step **9** reappears.

10 Press the [Start] key to print the list.**11** Press [PrevMenu].**12** Press [Exit] to return to standby mode.

Searching Memory for Received Faxes

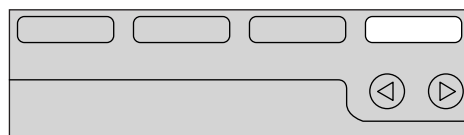
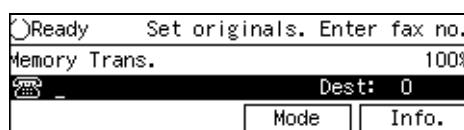
1 Press [Info.].

TKSS045N

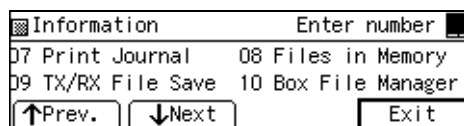
2 Enter the code for "TX/RX File Save" with the number keys.**Note**

- If the item you require is not displayed, press [↑Prev.][↓Next] until it is.

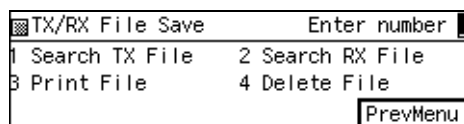
3 Enter the code for "Search RX File" with the number keys.

4 Press [Search].

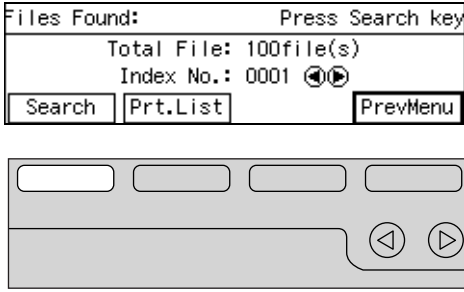

TKSS042N

Note

- To print a list off all files, press [Prt. List].

5 Enter the code of the search method you require.

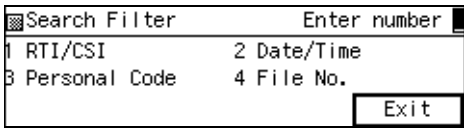

6 Carry out one of the following procedures appropriate the search method:

To Search By RTI/CSI

1 Enter the RTI or CSI using the Quick Dials or number keys.

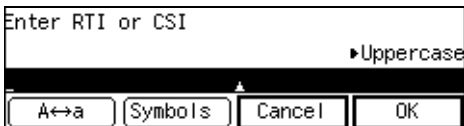

Note

- Press [A↔a] to switch between upper and lower case.
- Press [Symbols] if you wish to enter symbols.

2 Press [OK].

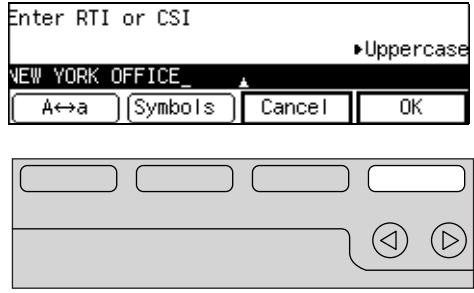

TKSS045N

Note

- If you press [Cancel], the machine returns to the display in step 5.

To Search By Date/Time

1 Enter the day with the number keys. Choose the month with [↑Month] or [↓Month]. Press the [▶] key, then enter the year and time with the number keys.

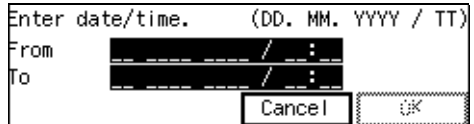

2 Press [OK].

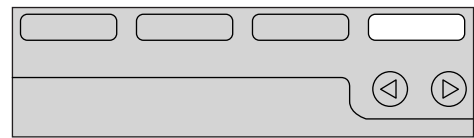
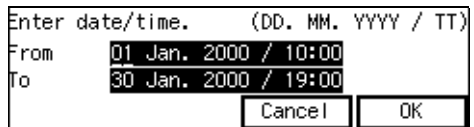

TKSS045N

Note

- If you press [Cancel], the machine returns to the display in step 5.

To Search By Personal Code (SUB Code)

- 1 Enter the Personal Code/SUB Code (up to 20 digits) with the number keys.

Enter personal code.

Personal Code:

Space Cancel OK

- 2 Press [OK].

Enter personal code.

Personal Code: 1111

Space Cancel OK

TKSS045N

Reference

P.122 "Personal Code Transmission".

Note

- ❑ If you press [Cancel], the machine returns to the display in step 5.

To Search By File Number

- 1 Enter the file number (4 digits) with the number keys.

Enter file number.

File No.:

Cancel OK

- 2 Press [OK].

Enter file number.

File No.: 0011

Cancel OK

TKSS045N

Note

- ❑ If you press [Cancel], the machine returns to the display in step 5.

- 7 Press [Exit].

Search Filter Enter number

1 RTI/CSI	2 Date/Time
3 Personal Code	4 File No.

Exit

TKSS045N

- 8 Press [Prt. List].

Files Found: Press Search key

Total File: 10file(s)

Index No.: 0001

Search Prt.List PrevMenu

TKSS043N

Note

- ❑ If you want to do a fresh search, press [Search] and return to step 5.
- ❑ Press to ⏪ ⏩ check through the file numbers of the search results.

- 9 Press **◀▶** to choose whether the image is printed.

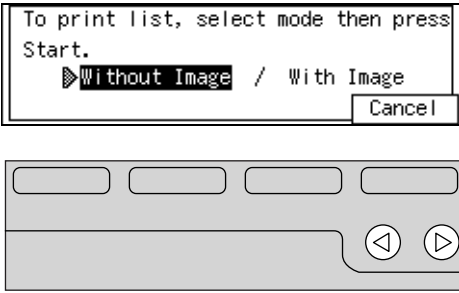

TKSS046N

Note

- To cancel this operation, press **[Cancel]**. The display in step 8 reappears.

5

- 10 Press the **[Start]** key to print the list.

- 11 Press **[PrevMenu]**.

- 12 Press **[Exit]** to return to standby mode.

Disk File Search List/Visual List

Print either of these lists for a hard copy of the search results generated by the Search TX File and Search RX File functions. You can choose to have the transmitted and received document images printed on this list.

If you choose “Without Image”, the Disk File Search List is printed.

If you choose “With Image” the Disk File Visual List is printed.

Printing Files

- 1 Press **[Info.]**.

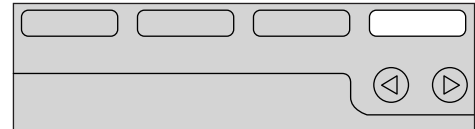

TKSS045N

- 2 Enter the code for “TX/RX File Save” with the number keys.

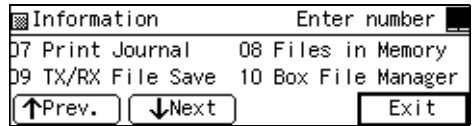

Note

- If the item you require is not displayed, press **[↑Prev.]** or **[↓Next]** until it is.

- 3 Enter the code for “Print File” with the number keys.

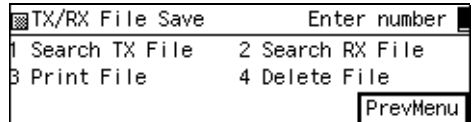

- 4 Enter the file number of the message you wish to print with the number keys.

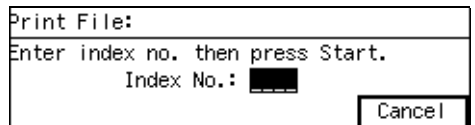

Note

- If you press **[Cancel]**, the machine returns to the display in step 3.

- If there is no matching file, “No matching file found.” is displayed.

5 Press the [Start] key to print the message.

6 Press [PrevMenu].

7 Press [Exit] to return to standby mode.

Deleting Files

1 Press [Info.].

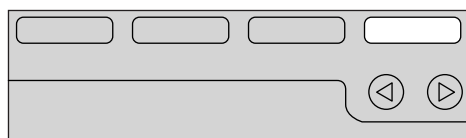

TKSS045N

2 Enter the code for “TX/RX File Save” with the number keys.

Note

- If the item you require is not displayed, press [↑Prev.] or [↓Next] until it is.

3 Enter the code for “Delete File” with the number keys.

4 Enter the file number of the message you wish to delete with the number keys.

Note

- If there is no matching file, “No matching file found.” is displayed.

5 Press [OK].

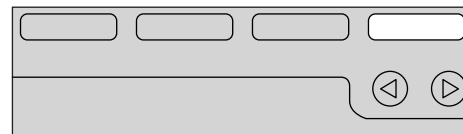

TKSS045N

Note

- If you press [Cancel], the machine returns to the display in step 3.

6 Press [Yes].

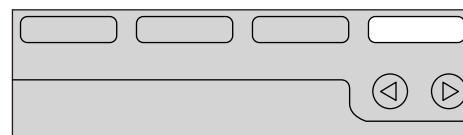

TKSS045N

Note

- If you press [No], the machine returns to the display in step 3.

7 Press [PrevMenu].

8 Press **[Exit]** to return to standby mode.

Box File Manager Functions

See the following pages for how to register, print and delete messages stored in box functions.

❖ Printing Personal Box Messages⇒ P.169

Print a message that has been received into a Personal Box.

❖ Storing Messages in Information Boxes⇒ P.170

Store a message in an Information Box.

❖ Printing Information Box Messages⇒ P.171

Print a message stored in a Information Box.

❖ Deleting Information Box Messages⇒ P.173

Delete a message stored in a Information Box.

Printing Personal Box Messages

Follow these steps to print a message that has been received into a Personal Box.

Note

- The  indicator lights when a message has been received into a Personal Box.
- If you print a Personal Box message, it is deleted.

1 Press [Info.].

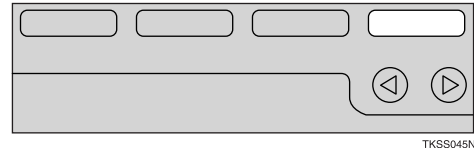
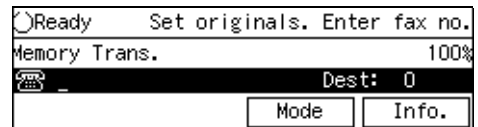

TKSS045N

2 Enter the code for “Box File Manager” with the number keys.

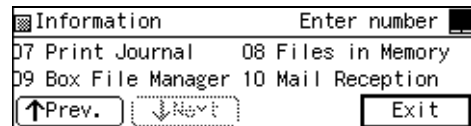

Note

- If the item you require is not displayed, press [↑Prev.] or [↓Next] until it is.

3 Enter the code for “Personal Box Prt.” with the number keys.

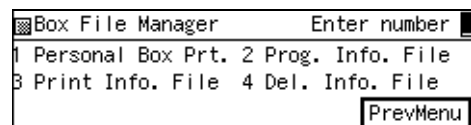

4 Enter the SUB code of the Personal Box you wish to print, then press [OK].

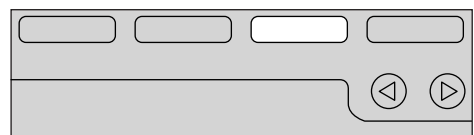
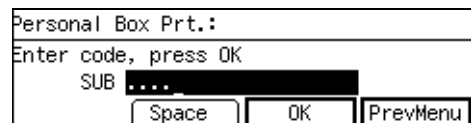

TKSS044N

Note

- ❑ If a password is stored, enter the password then press **[OK]**.

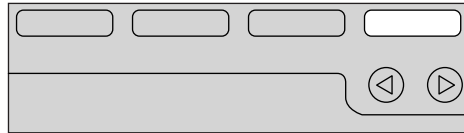
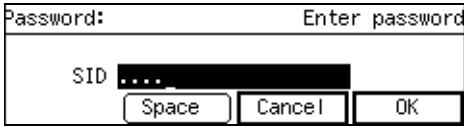

TKSS045N

- ❑ If you press **[Cancel]**, the machine returns to the display in step 4.
- ❑ If there are no received messages, “No matching file found.” is displayed then the screen in step 5 reappears.

5 Press the **[Start]** key to print the message.

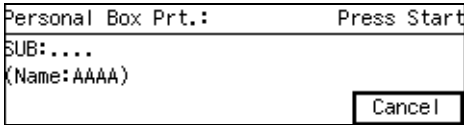

Note

- ❑ To stop printing, press the **[Stop]** key. The display in step 4 will reappear.

6 Press **[PrevMenu]**.

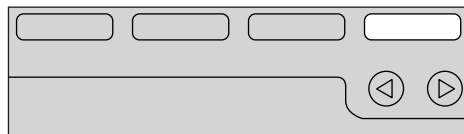
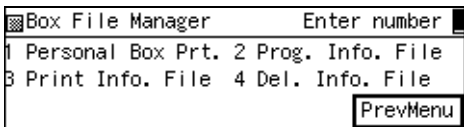

TKSS045N

Note

- ❑ If there are messages in other Personal Boxes, the display in step 4 will reappear, so press **[PrevMenu]** twice.

7 Press **[Exit]** to return to standby mode.

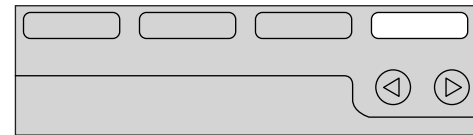
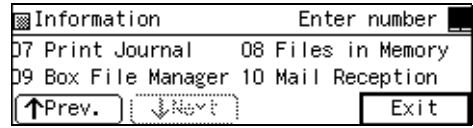

TKSS045N

Storing Messages in Information Boxes

Follow these steps to store a message in an Information Box.

1 Press **[Info.]**.

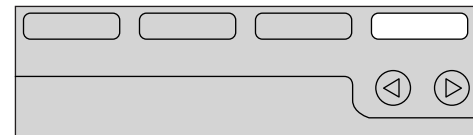
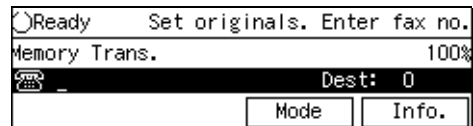

TKSS045N

2 Enter the code for “Box File Manager” with the number keys.

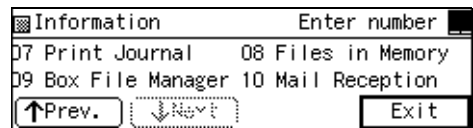

Note

- ❑ If the item you require is not displayed, press [**↑**Prev.] or [**↓**Next] until it is.

- Enter the code for “Prog. Info. File” with the number keys.

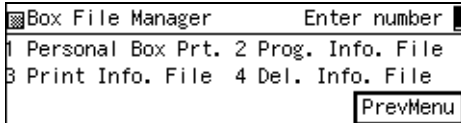

- Enter the SEP code of the Information Box you wish to store the message in, then press [OK].

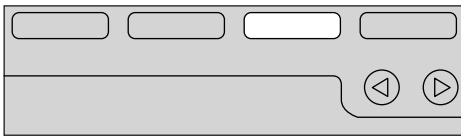
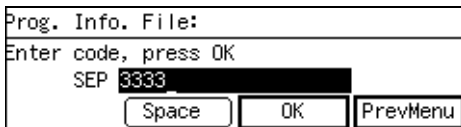

TKSS044N

Note

- ❑ If a password is stored, enter the password then press [OK].

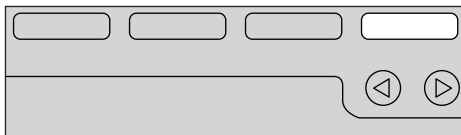
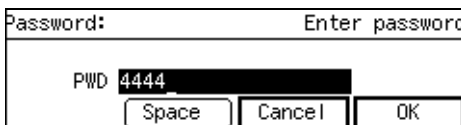

TKSS045N

- ❑ If you press [Cancel], the display in step 4 reappears.

- Set the document you wish to store, and adjust any scan settings as necessary.

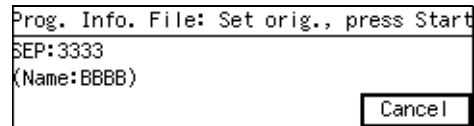

- Press the [Start] key.

Your document is scanned in.

To cancel scanning, press the [Stop] key. The display in step 4 reappears.

- Press [PrevMenu].

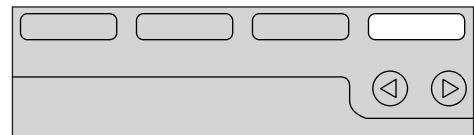
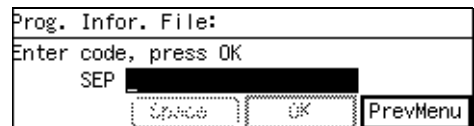

TKSS045N

- Press [PrevMenu].

- Press [Exit] to return to standby mode.

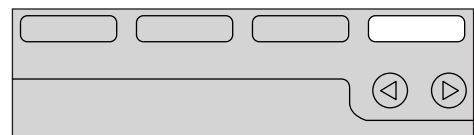
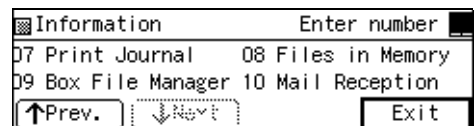

TKSS045N

Printing Information Box Messages

Follow these steps to print a message stored in an Information Box.

1 Press [Info.].

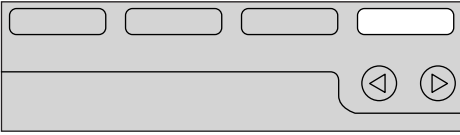
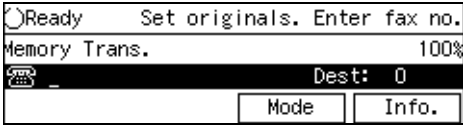

TKSS045N

2 Enter the code for “Box File Manager” with the number keys.

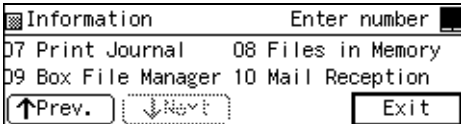

Note

- ❑ If the item you require is not displayed, press [↑Prev.] or [↓Next] until it is.

3 Enter the code for “Print Info. File” with the number keys.

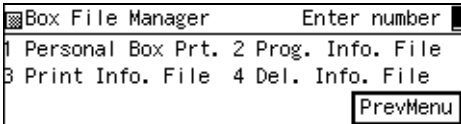

4 Enter the SUB/SEP code stored for the Information Box, then press [OK].

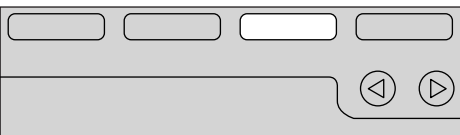
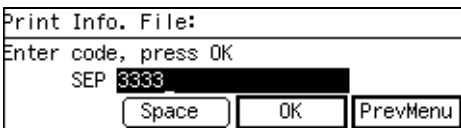

TKSS044N

Note

- ❑ If a password is stored, enter the password then press [OK].

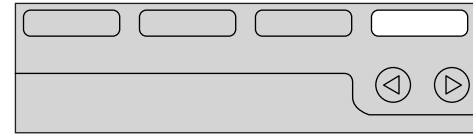
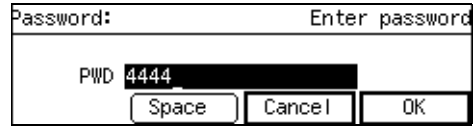

TKSS045N

- ❑ If you press [Cancel], the display in step 4 reappears.
- ❑ If no message is stored, “No matching file found.” is displayed and the screen in step 4 reappears.

5 Press the [Start] key.

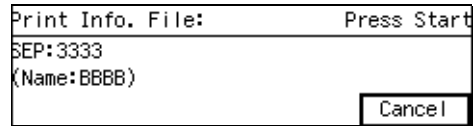

The message is printed.

Note

- ❑ To cancel printing, press the [Stop] key. The display in step 4 reappears.

6 Press [PrevMenu].

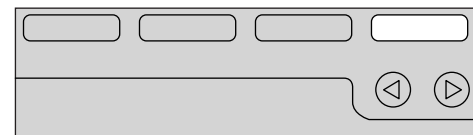
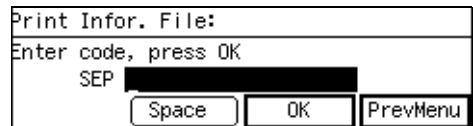

TKSS045N

Note

- ❑ If messages are stored in other Information Boxes, the display in step 4 appears, so press [PrevMenu].

7 Press [PrevMenu].

8 Press [Exit] to return to standby mode.

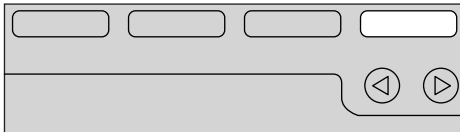
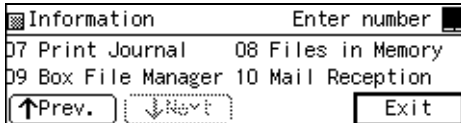

Deleting Information Box Messages

Follow these steps to delete a message stored in a Information Box.

1 Press [Info.].

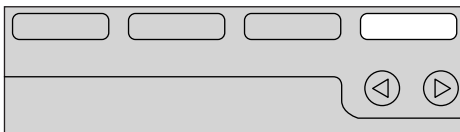
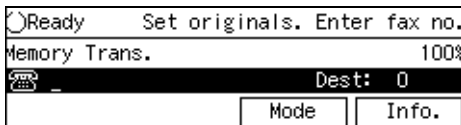

2 Enter the code for “Box File Manager” with the number keys.

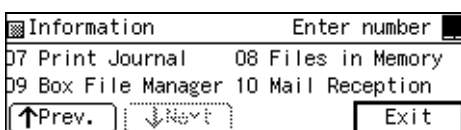
**Note**

- ❑ If the item you require is not displayed, press [↑Prev.] or [↓Next] until it is.

3 Enter the code for “Del Infor. File” with the number keys.

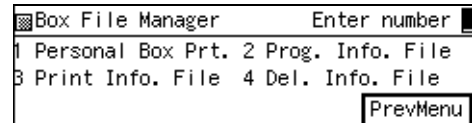

4 Enter the SEP code of the Information Box you wish to delete, then press [OK].

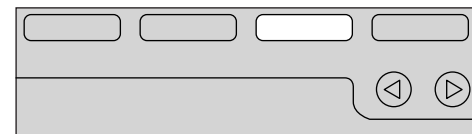
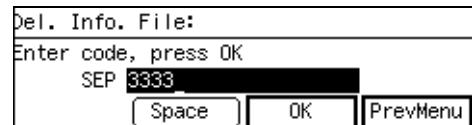
**Note**

- ❑ If a password is stored, enter the password then press [OK].

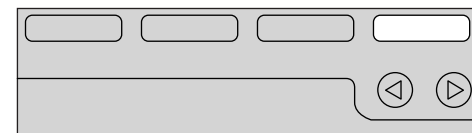
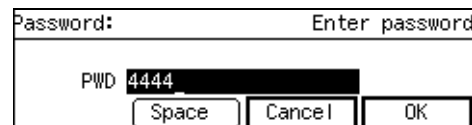

- ❑ If you press Cancel, the display in step 4 reappears.

- ❑ If no message is stored, “No matching file found.” is displayed and the screen in step 4 reappears.

5 Press [Yes].

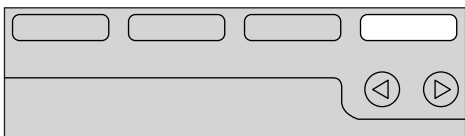
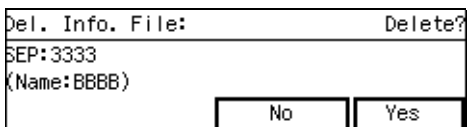

TKSS045N

Note

- ❑ If you press [No], the message is not deleted and the display in step 4 reappears.

6 Press [Yes].

The Information Box message is deleted.

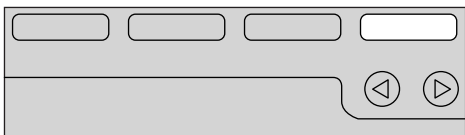
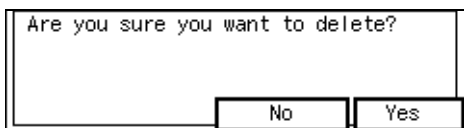

TKSS045N

Note

- ❑ If you press [No], the message is not deleted and the display in step 4 reappears.

7 Press [PrevMenu].

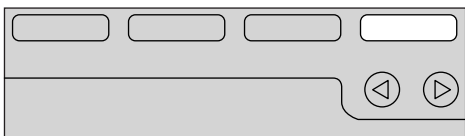
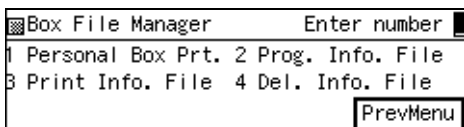

TKSS045N

Note

- ❑ If messages are stored in other Information Boxes, the display in step 4 appears, so press [PrevMenu] twice.

8 Press [Exit] to return to standby mode.

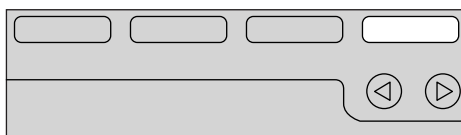
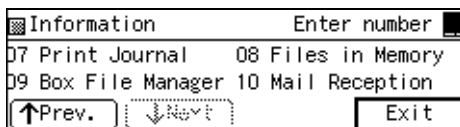

TKSS045N

Copying

This section describes how to make copies.

Important

- ❑ When making multiple copy sets, copying starts once all originals have been scanned into memory. If memory runs out (free memory reaches 0%) while scanning in, the copy job is canceled and originals that have been scanned in so far are deleted from memory.

Limitation

- ❑ The margins of error when copying at 100% magnification are as follows:
 - Horizontal: +2.0%, -2.5%
 - Vertical: +1.5%, -2.0%
- ❑ You can specify between 1 and 99 copies.
- ❑ You cannot interrupt a fax operation while it is in progress to make copies.
- ❑ In copy mode you cannot set the Resolution to Fine.

Note

- ❑ Set your original and select any scan settings in the same way as for fax transmission.
- ❑ Recommended originals are the same as recommended documents for fax transmission.
- ❑ Multiple copy sets are sorted and delivered in page order.

- ❑ If you wish to prevent passersby from freely making copies, you can disable the copy feature with the User Parameters(⇒ P.250). By default, the copy feature is enabled.

- 1** Make sure that the machine is in standby mode.

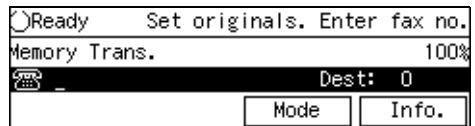

Note

- ❑ If the “Fax Features” or “Key Op. Tools” screen is shown, press the [User Tools] key. If any other display is shown, press the [Clear Modes/Energy Saver] key.

- 2** Press the [Copy] key.

If you press this key again, the original display reappears.

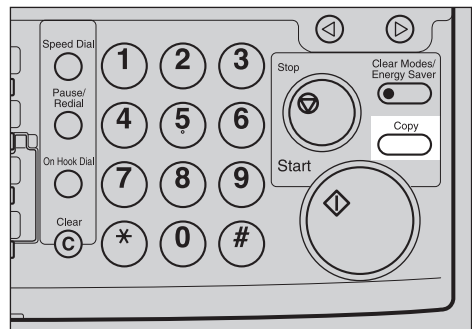

TKSS029E

- 3** Set your original and adjust any scan settings as necessary.

- 4** Press the ◀ or ▶ keys to select the copy paper size.

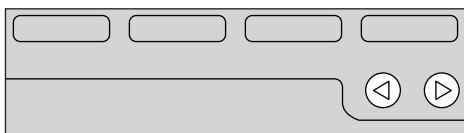
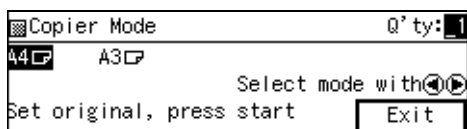

TKSS046N

Limitation

- ❑ If you choose copy paper narrower than the original, copies will be reduced in size.
- ❑ If your original is longer than the copy paper you choose, only the length of the copy paper will be copied.

- 5** If you are making multiple copies, enter the number of copies with the number keys.

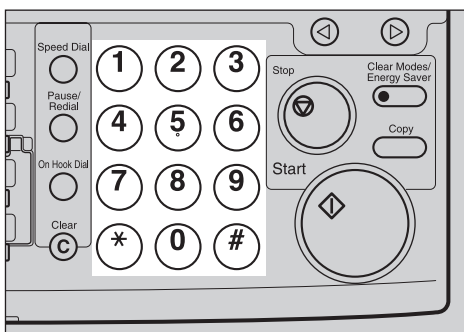

TKSS025E

Note

- ❑ If you make a mistake, press the [Clear] key and try again.

- 6** Press the [Start] key to start copying.

When copying has finished the original display reappears.

Note

- ❑ To stop copying while it is progress, press the [Stop] key. Then open the ADF cover and ADF unit and remove any paper that is left. ⇒ P.182 "Clearing Paper Jams"

7. Troubleshooting

Solving Problems

This table lists some common problems and their solutions.

Problem	Solution	Refer to
Cannot transmit or receive	The line cord may have become disconnected. Make sure it is correctly connected.	P.29 <i>"Connecting the machine to the telephone line"</i>
You want to cancel a Memory Transmission.	If the document is being stored, press the [Stop] key.	P.66 <i>"Canceling a Memory Transmission"</i>
	If the document is being sent, use "Check/Cancel TX Files" in the "Information" menu.	P.143 <i>"Checking and Canceling Transmission Files"</i>
You want to cancel an Immediate Transmission.	Press the [Stop] key.	P.72 <i>"Canceling an Immediate Transmission"</i>
Multiple sheets are fed into the ADF at the same time, or the document will not feed in at all.	If the document is too thick, too thin, or the back surface is slippery, it might not be fed into the ADF properly. Only set appropriate types of document in the ADF.	P.53 <i>"Recommended Paper"</i>
Image background appears dirty when received at the other end.	Adjust the scan density.	P.77 <i>"Image Density"</i>
Printed or sent image contains spots.	The Document Feeder (ADF) is dirty. Make sure that ink or eraser is dry before setting documents.	P.325 <i>"Maintaining the Machine"</i>
Message appears blank at the other end.	The document was set with the wrong side facing down. Set it with the opposite side facing down.	P.50 <i>"How to Set a Document"</i>

Problem	Solution	Refer to
<p>Received image is too light.</p>	<p>Request the sender to increase the image density.</p>	<p>P.47 <i>“Acceptable Types Of Documents”</i></p>
	<p>When using moist, rough or processed paper, the printed image may be partly invisible. Only use recommended paper types.</p>	
	<p>When  is flashing, toner is beginning to run out. Replace the toner cartridge soon.</p>	<p>P.28 <i>“Installing the Toner Cartridge”</i></p>
<p>You cannot add any destinations to a Group even though the maximum capacity does not seem to have been reached.</p>	<p>100 (with the optional Function Upgrade Card it is 1000) destinations have been programmed with the number keys. Program additional destinations with Quick Dials or Speed Dials instead.</p>	<p>P.81 <i>“Number Keys”</i></p>
<p>Cannot print onto paper even though it is of an appropriate size.</p>	<p>Make sure the paper size detection plate for the main paper tray or optional supply unit matches the paper size actually loaded in that tray or unit.</p>	<p>P.30 <i>“Loading Paper”</i></p>

Error Messages and Their Meanings

If there is an error, one of the following messages may appear on the display. It might just flash up briefly, so if you are watching for errors, stay by the machine and check the display.

Message	Problem and Solution
Document Misfeed. Scanned pages have been deleted.	Original jammed during Memory Transmission. Reset documents that haven't been scanned.
Communication error: Press the Stop key.	<p>An error occurred during Immediate Transmission. Press [OK] and re-send the document.</p> <p> Note</p> <ul style="list-style-type: none"> <input type="checkbox"/> There may be a problem with the machine or the telephone line (e.g. noise or cross talk). If the error re-occurs frequently, contact your service representative.
Memory has reached its limit. Document being loaded was deleted.	Transmission has halted because the memory capacity has been reached. Split the document and send each part separately.
Printing error: check cover and/or paper.	<ul style="list-style-type: none"> • Cannot print or lists because paper has run out. Load more paper. • Paper is jammed. Remove it. • The side cover is open. Close it.
Limit reached: replace the document transport roller and clear the counter.	It is time to install a new Fusing Unit Maintenance kit.
Limit reached: replace the copy unit and clear the counter.	It is time to install a new ADF Unit Maintenance Kit.
Service call error. Press OK to end alarm.	There is a problem with the fax function. Contact your service representative and tell the code number shown in the display.

Clearing Document Jams

If document is jammed, the  indicator on the operation panel lights and a message appears on the display indicating the location of the jam.

Use one of the following procedures to clear the jammed document.

Clearing Document Jams in the ADF

If you experience frequent document jams in the ADF, clean the ADF or obtain a new ADF Maintenance Kit. ⇒ P.325 “Maintaining the Machine”.

Important

- Strongly pulling documents out of the ADF without opening the cover may result in documents being ripped and/or damage to the machine.

1 Open the ADF cover.

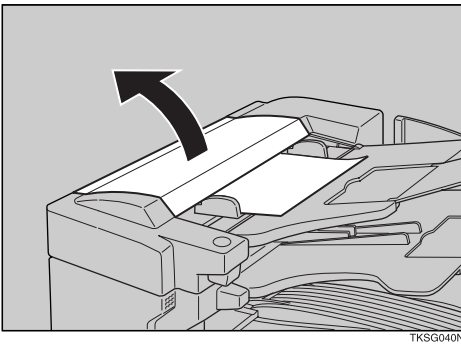

TKSG040N

2 While squeezing in the release lever, open the ADF cover.

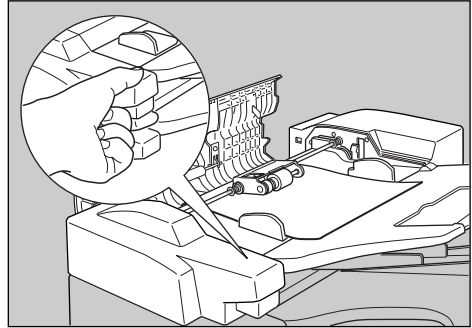

TKSG060N

3 Remove the document in one of the following ways depending on where it is jammed:

In the top unit

1 While supporting the ADF unit with your hand, gently pull out the jammed document.

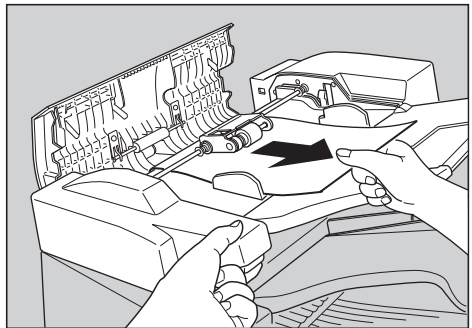

TKSG070N

Important

- If you strongly pull out the document, it could be ripped or the machine could be damaged.

In the lower unit

- 1 While supporting the ADF unit with your hand, gently pull out the jammed document.

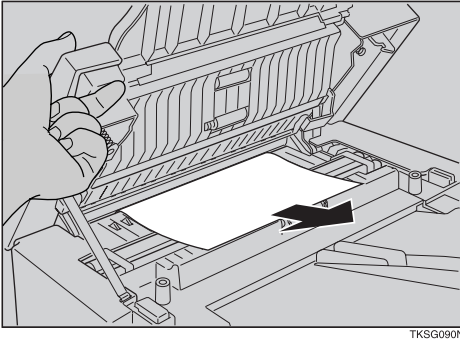

Important

- If you strongly pull out the document, it could be ripped or the machine could be damaged.

- 4 Close the ADF cover/ADF unit making sure it clicks firmly into place.

Clearing Document Jams in the Bypass Tray

- 1 While squeezing in the release lever, open the ADF cover.

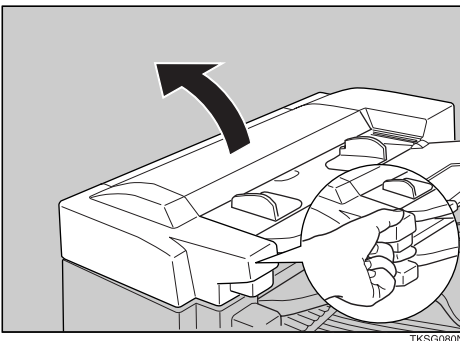

- 2 Gently pull out the jammed document.

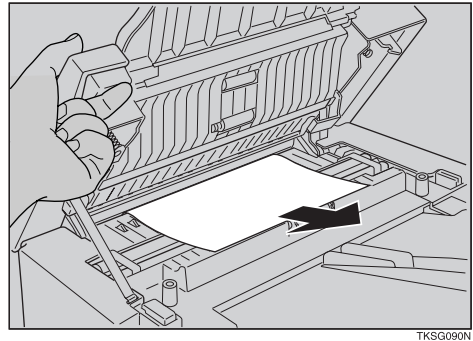

Important

- If you strongly pull out the document, it could be ripped or the machine could be damaged.

- 3 Close the ADF unit making sure it clicks firmly into place.

Clearing Paper Jams

If copy paper is jammed, the  indicator on the operation panel lights and a message appears on the display indicating the location of the jam.

Use one of the following procedures to clear the jammed paper.

 **Limitation**

- You cannot open the paper tray side cover when the main side cover is open. Close the main side cover first.

 **Note**

- The display may indicate that paper is jammed in more than one location. In this case, check for jammed paper in all locations listed.

- 2** Lower the fusing unit pressure release lever in the direction of the arrow.

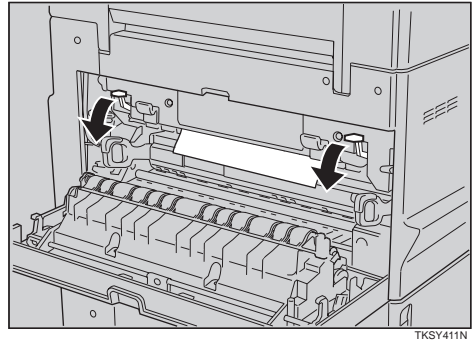

- 3** Pull out the jammed paper.

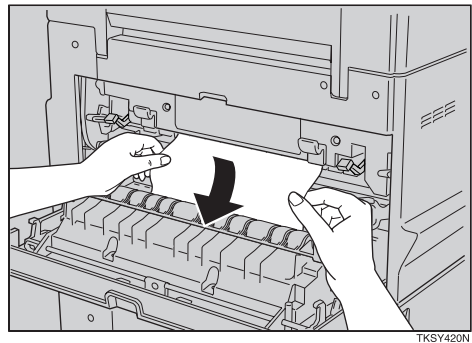
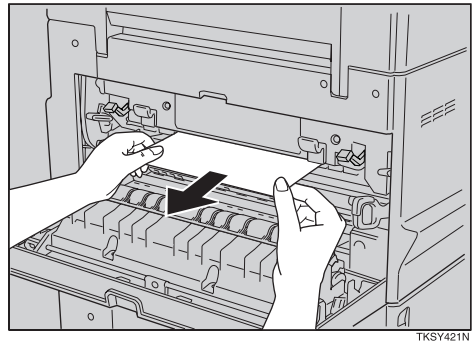

7 Clearing Paper Jams in the Fusing Unit

When paper is not delivered to the output tray, paper may be jammed in the fusing unit.

Follow these steps to clear the jam.

- 1** Open the main side cover in the direction of the arrow.

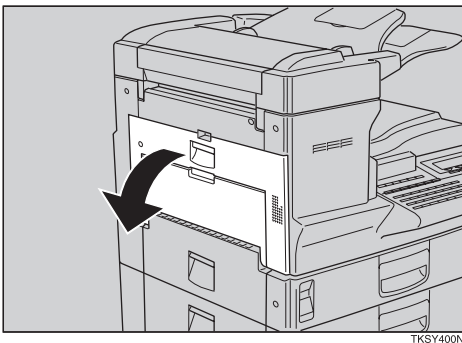

 **Important**

- If you strongly pull out the paper, it could be ripped or the machine could be damaged.

When paper is caught in the lower unit

- 1 Remove the paper by pulling the whole page upwards.

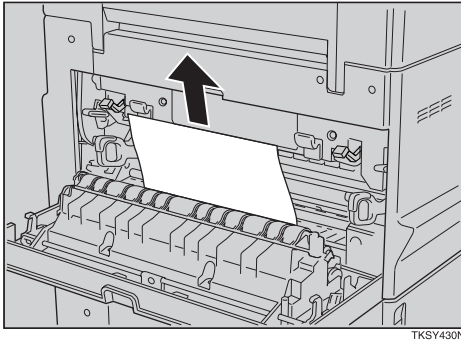

Important

- If you strongly pull out the paper, it could be ripped or the machine could be damaged.

- 4 Return the fusing unit pressure release lever to its original position.

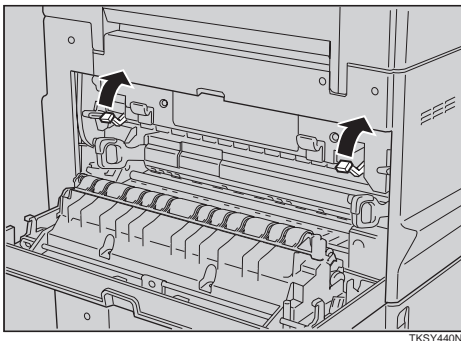

- 5 Close the main side cover making sure it clicks firmly into place.

Important

- If paper jams persist in the fusing unit, please contact your service representative for how to obtain a new Fusing Unit Maintenance Kit.

Clearing Paper Jams in the Main Paper Tray

- 1 Open the main paper tray side cover in the direction of the arrow.

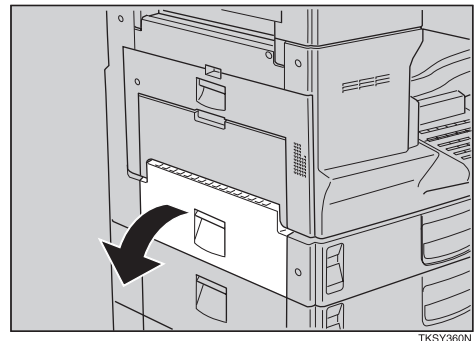

- 2 If there is jammed paper, slowly pull it out.

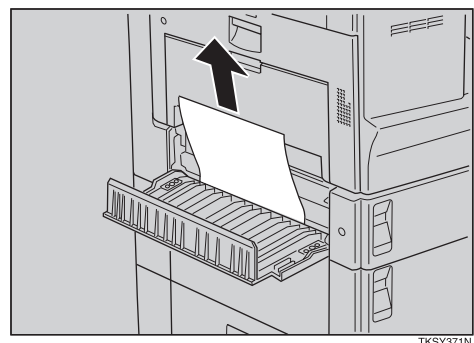
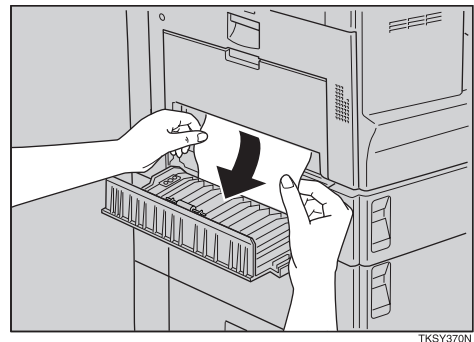

Important

- If you strongly pull out the paper, it could be ripped or the machine could be damaged.

3 Close the side cover making sure it clicks firmly into place.

4 Pull out the main paper tray in the direction of the arrow.

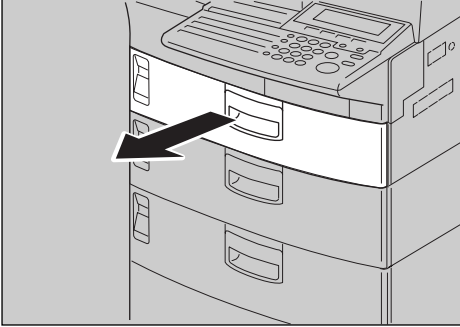

TKSY380N

5 If there is jammed paper, slowly pull it out.

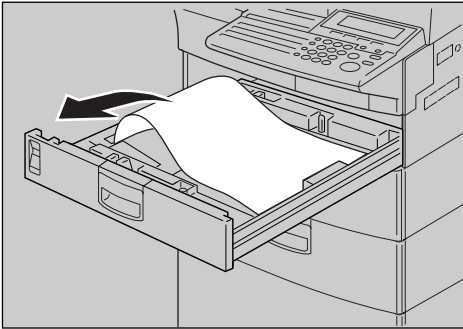

TKSY390N

Important

If you strongly pull out the paper, it could be ripped or the machine could be damaged.

6 Close the main paper tray making sure it clicks firmly into place.

Clearing Paper Jams in the Optional Paper Supply Unit

1 Open the paper supply unit side cover in the direction of the arrow.

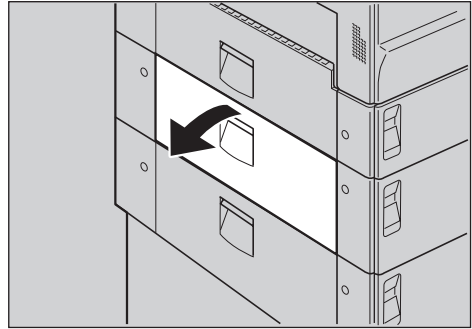

TKSY361N

2 If there is jammed paper, slowly pull it out.

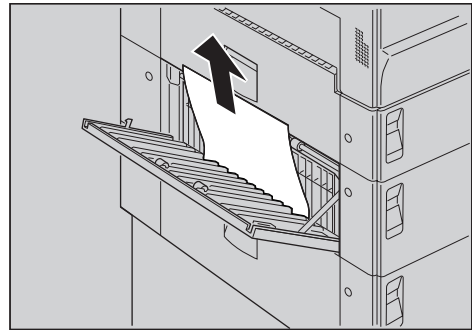

TKSY362N

Important

If you strongly pull out the paper, it could be ripped or the machine could be damaged.

3 Close the side cover making sure it clicks firmly into place.

- 4** Pull out the optional paper supply unit in the direction of the arrow.

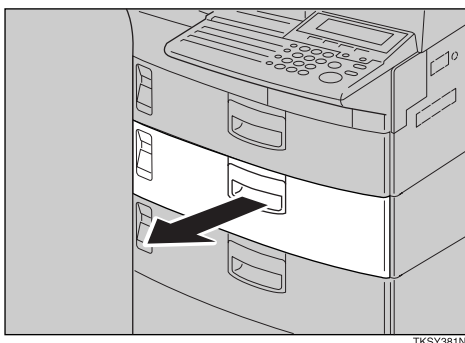

- 5** If there is jammed paper, slowly pull it out.

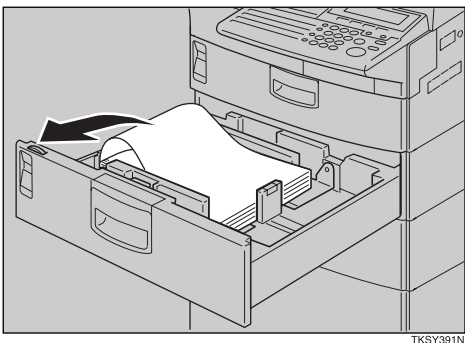

Important

- If you strongly pull out the paper, it could be ripped or the machine could be damaged.

- 6** Close the optional paper supply unit making sure it clicks firmly into place.

Replacing the Toner Cartridge

When  is displayed, the toner is almost running out. Prepare a new toner cartridge. If the image density gets too light, replace the toner cartridge with a new one.

Important

- Used toner cartridges can be recycled. Please contact the seller of this machine.
- Always turn off the machine's main power switch before replacing the toner cartridge.
- Always use toner cartridges recommended specifically for this model. Using any other type could damage the machine.
- Do not leave the main side cover open for a protracted length of time. Exposing the toner cartridge to light for an extended period of time may cause it to deteriorate, so replace the cartridge as quickly as possible.
- Do not stand the toner cartridge upside down or at an angle.

Note

- The average number of printed pages that can be expected from the toner cartridge is approximately 10,000 sheets (A4, 4% black). In practice, the lifetime of the toner cartridge will vary depending on the paper type, paper size, printed images, and machine environment. For this reason, it may be necessary to replace the toner cartridge more often than stated above.

- 1** Open the main side cover in the direction of the arrow.

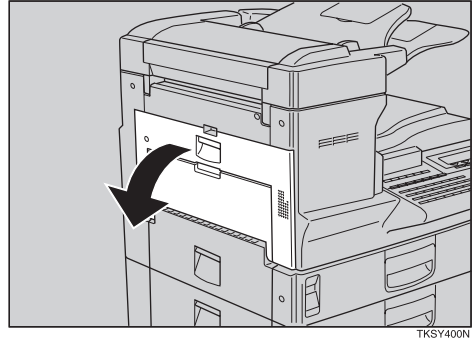

- 2** Grasp the handles at both ends and remove the toner cartridge.

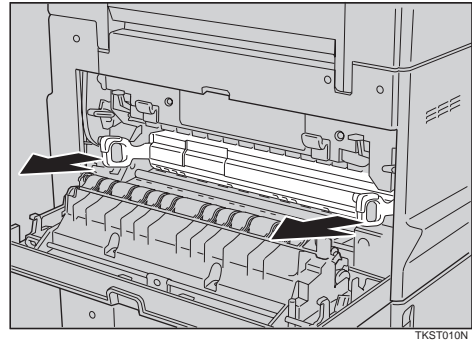

- 3** Shake the new toner cartridge from left to right, and backwards and forwards about 7 or 8 times.

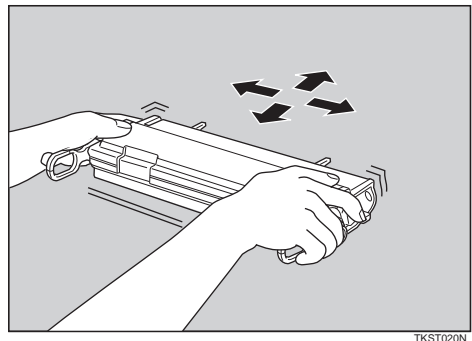

Note

- ❑ Unevenly distributed toner within the cartridge may result in reduced print quality.

- 4** Place the toner cartridge on a flat surface. While supporting the cartridge with one hand, pull the toner seal horizontally to remove it.

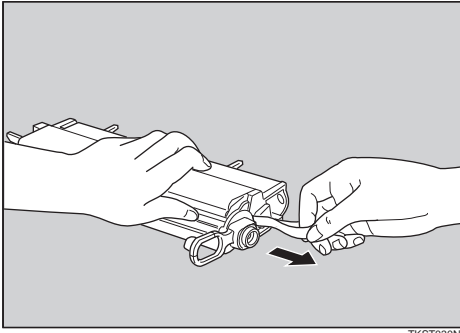

TKST030N

Important

- ❑ Using the cartridge without removing the seal could damage the machine. Always remove the seal before using a new cartridge.
- ❑ Be sure to pull the seal horizontally when removing it. Pulling it from above or below can cause toner to easily spill out.
- ❑ Be careful not to get toner on your hands or clothes.
- ❑ Once the seal is removed, toner can easily spill out, so pay attention not to shake or bump it.

- 5** Grasp the two handles at either end and push the cartridge into the machine.

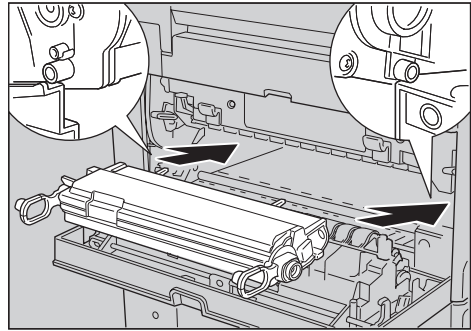

TKST040N

- 6** Close the main side cover making sure it clicks firmly into place.

Important

- ❑ The front cover will not close properly if the toner cartridge is set into the machine incorrectly. If the cover will not close, remove the cartridge and set it again.



Indicators

When the Receive File Indicator is Lit

If the Receive File indicator is lit, a message has been received but could not be printed for some reason. The message was stored in memory using a feature called Substitute Reception. When you solve the problem, the message will be automatically printed out. The table below lists some problems that could have caused Substitute Reception to take place and their solutions.

 **Reference**

P.103 “Substitute Reception”

Why Substitute Reception Occurred	Indication/Status	Solution
Paper has run out.	 is lit red.	Add paper. ⇒ P.30 “Loading Paper”
Toner has run out.	 is lit red.	Replace the toner cartridge. ⇒ P.186 “Replacing the Toner Cartridge”
Paper is jammed.	 is lit red.	Remove the jammed paper. ⇒ P.180 “Clearing Document Jams”
Cover is open.	“Cover open. Please shut the cover marked with the arrow.” is displayed.	A cover other than the Auto Document Feeder (ADF) or front cover is open.
Machine is busy printing with another function.	Another function, such as the optional printer function, is currently printing.	The message will be printed after the current job finishes automatically.

When the Confidential Reception/Memory Lock Indicator is Lit or Flashing

If this indicator is lit, you have received a message using Confidential Reception. For how to print it out, see P.152 “Printing a Confidential Message”.

If this indicator is flashing a message has been received with the Memory Lock feature.

For how to print it out, see P.154 “Printing a File Received with Memory Lock”.

When the Cover Open Warning Indicator is Lit

This indicator lights and a message appears on the display to alert you that a cover on the main machine or in the paper supply area is open. Check the display message and close the cover(s).

When the Paper Jammed Indicator is Lit

This indicator lights when paper is jammed in the machine. Check the message shown on the display and remove the jammed paper.

Reference

P.180 *"Clearing Document Jams"*

When the Add Toner Indicator is Lit or Flashing

This indicator lights to inform you that there is not much toner left in the toner cartridge.

When the following message appears on the display, it is time to load a new toner cartridge: Out of toner. Replace toner cartridge using instructions inside the unit.

Reference

P.28 *"Installing the Toner Cartridge"*

Faxing when toner has run out

You can still send faxes from this machine even if toner has run out.

Important

- If the combined total number of communications that take place when toner has run out and number of communications that have not yet been automatically printed on the Journal exceeds 250 (1,000 when the optional Function Upgrade Card is installed), the Journal information is deleted and you cannot check it.

- 1** Press [OK] to close the error window.

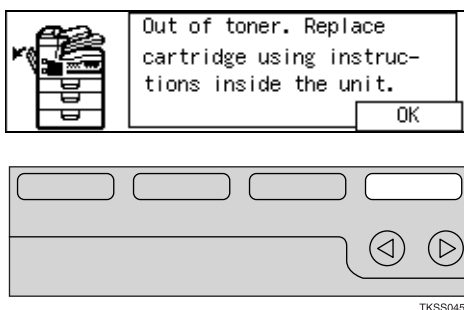

- 2** Send your fax message as you would normally.

 **Reference**

P.60 "Memory Transmission"

P.69 "Immediate Transmission"

When the Paper Supply Indicator is Lit

The machine has run out of paper.

 **Reference**

For how to load paper, see P.30 "Loading Paper".

When the Call Service Indicator is Lit

The machine has broken down. Please contact your service representative.

When an Error Report is Printed

An error report is printed when a message could not be successfully sent or received.

Possible causes include a problem with your machine or the receiver's, noise on the telephone line etc. If an error occurs during transmission, re-send the document. If an error occurs during reception, ask the sender to re-send the message.

 **Note**

- If the error happens frequently, please contact your service representative.

When Power is Turned Off or Fails

Even if the power switch is turned off, the contents of the machine's memory (programmed numbers etc.) will not be lost. However, if power is lost for more than 1 hour through the power switch being turned off, a power outage or the power cable being removed, memory contents will be lost. Lost items will include any fax messages stored in memory using Memory Transmission or Reception.

If a file has been deleted from memory, a Power Failure Report is automatically printed as soon as power is restored. This report can be used to identify lost files. If a document stored for Memory Transmission was lost, re-send it. If a message received by Memory Reception or Substitute Reception was lost, ask the sender to re-send it. If an Auto Document was lost, you will need to store it in memory again.

Important

- Make sure that 100% is shown on the display before you unplug the machine. If a lower value is shown, some data is currently stored in memory.

8. Fax Features

Fax Features

The “Fax Features” menu allows you to program the machine with your identification, store frequently used numbers and settings, and customize the default settings to match your needs.

So you can find the function menus you require quickly and easily, they are grouped by function:

❖ **Program/Delete⇒ P.194**

Use to program or delete: Quick Dials, Groups, Speed Dial, Keystroke Programs, Auto Documents

❖ **Reports/Lists⇒ P.223**

Use to print: the Journal, Quick Dial List, Group Dial list, Keystroke Program list, Speed Dial list, Auto Documents

❖ **User Functions⇒ P.225**

Use to program settings you frequently use into the User Function Keys

❖ **Fax On Demand (optional Fax On Demand required)⇒ P.230**

The following settings are for the optional fax information service feature:

- Program/Edit/Delete Fax On Demand
- Print Fax On Demand Document
- Print Fax On Demand List
- Print Fax On Demand Access Report
- Register Fax On Demand Audio Prompts

 **Note**

- ❑ For the order in which the Fax Features settings are displayed, see P.338 “*Function List*”.
- ❑ For detailed information on the above functions, refer to the page reference given.

❖ **Navigating Menus**

- Press [**↑Prev.**] and [**↓Next**] to switch between screens.
- Press [**PrevMenu**] to return to the Previous menu.
- Items that are currently selected appear highlighted.
When you have finished, press [**OK**]. If you do not press [**OK**], any changes to the Fax Features settings you have made are not applied.
- Press [**OK**] or [**Cancel**] to return to the previous display.

Program/Delete Menu

Registering Quick Dials

To save time, you can program a fax number that you use often into a Quick Dial key. Then, whenever you are sending a message to that location, just press that Quick Dial key to dial.

Use the following steps to program a new Quick Dial or to edit or overwrite existing Quick Dials. There are 64 Quick Dials available.

You can register the following items in each key:

- Destination fax number (up to 254 digits)
- When the optional G4 Unit or optional G3 Unit is installed, you can select which line to use (G3 or G4) before entering the fax number.
- Destination name (up to 20 characters)

Important

- ❑ We recommend that you print the Quick Dial list and keep it when you program or change fax numbers. ⇒ P.223 "Reports/Lists"

Limitation

- ❑ When a registered Quick Dial key is being used for a standby Memory Transmission, the message "Already used in other file. Cannot be changed." is shown and you cannot change the destination for this key.

- 1** Make sure that the machine is in standby mode.

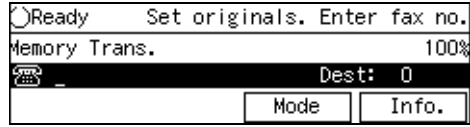

Note

- ❑ If the "Fax Features" or "Key Op. Tools" screen is shown, press the [User Tools] key. If any other display is shown, press the [Clear Modes/Energy Saver] key.

- 2** Press the [User Tools] key.

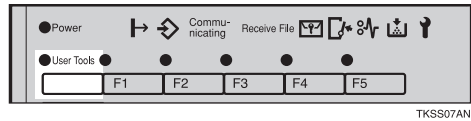

- 3** Enter the code for "Fax Features" with the number keys.

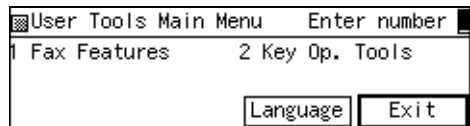

The "Fax Features" menu appears.

- 4** Enter the code for "Program/Delete" with the number keys.

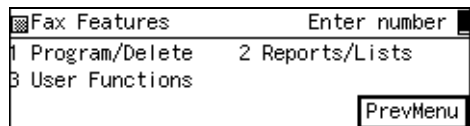

- 5** Enter the code for "Prog. Quick Dial" with the number keys.

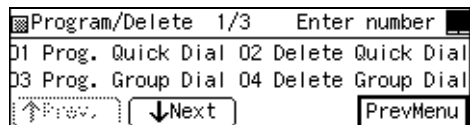

- 6** Press the Quick Dial key which you want to register.

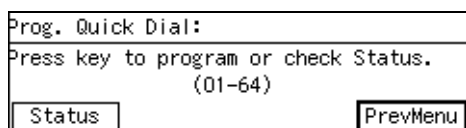

To check on already stored destinations, press the **[Status]** key.

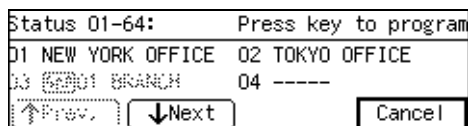

- 7** Enter a fax number using the number keys.

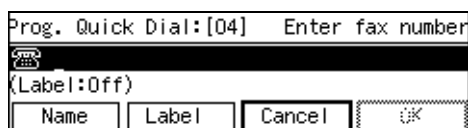

Note

- When optional G4 unit or optional G3 unit is installed, you can select which line to use (G3 or G4) before entering the fax number.
- If you make a mistake, press the **[Clear]** key or **[Stop]** key and try again. The **[Clear]** key deletes one character at a time, and the **[Stop]** key deletes the whole line.
- If a Quick Dial has already been stored, the contents are displayed. If you wish to edit it, press the Clear key and enter it again.
- You cannot omit the fax number.

Choosing the line (the **[Line Selection]** key)

- 1** Press the **[Line Selection]** key to select the line.

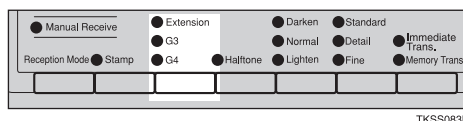

Choosing the line (the User Function key)

- 1** Press the User Function key (F1-F5) programmed with the Line Select feature.

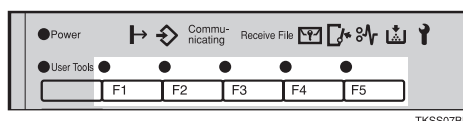

- 2** Press the **[Left Arrow]** or **[Right Arrow]** keys to select the line.

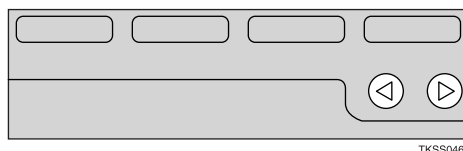
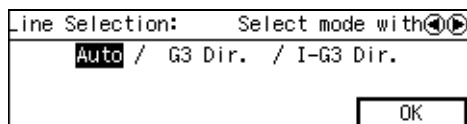

- 3** Press **[OK]**.

To store or edit a name for this destination

- 1** Press **[Name]**.
- 2** Enter the destination name.

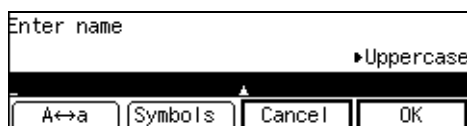

Note

- ❑ If a destination name is already registered in this Quick Dial key, the name is shown on the display. If you wish to change this name, press the **[Clear]** key and enter another name.

Reference

P.319 "Entering and Modifying Text"

3 Press [OK].

The fax number and name are displayed.

Label Insertion

If you turn this setting on, the label stored for this Quick Dial will be automatically stamped on the first page of messages you send when printed at the other end.

1 Press [Label].

- 2** Press the **[Left]** or **[Right]** keys to choose on or off.

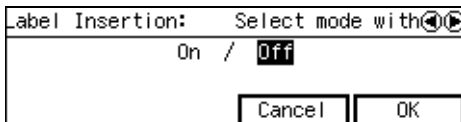
**3 Press [OK].****8 Press [OK].**

The display in step **6** reappears.

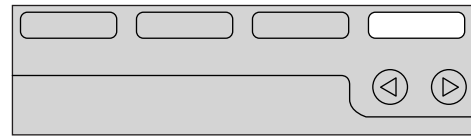
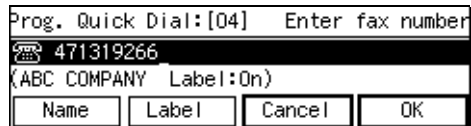
**Note**

- ❑ If you press Cancel, the information you have just entered is deleted and the display in step **6** reappears.

9 Press [PrevMenu] three times.

- 10** Press **[Exit]** to return to standby mode.

Quick Dial List

Printing the Quick Dial list allows you to check destinations registered in Quick Dial keys. ⇒ P.223 "Reports/Lists"

Quick Dial Key and Function Key Label (Quick Key Label)

You can print a template that can be used to make labels for Quick Dial and User Function keys. The template will have destination or Group names programmed in Quick Dials, and the names of functions assigned to User Function keys.

Note

- ❑ A protective transparent film is attached to the operation panel. Peel off the film and stick the Quick Key Label on the operation panel.
- ❑ Cut out the Quick Key Label and glue it onto the operation panel. When you stick it on, avoid covering the sensor near Quick Dial 56 (right corner).

☐ To print the label template, see P.223 "Reports/Lists".

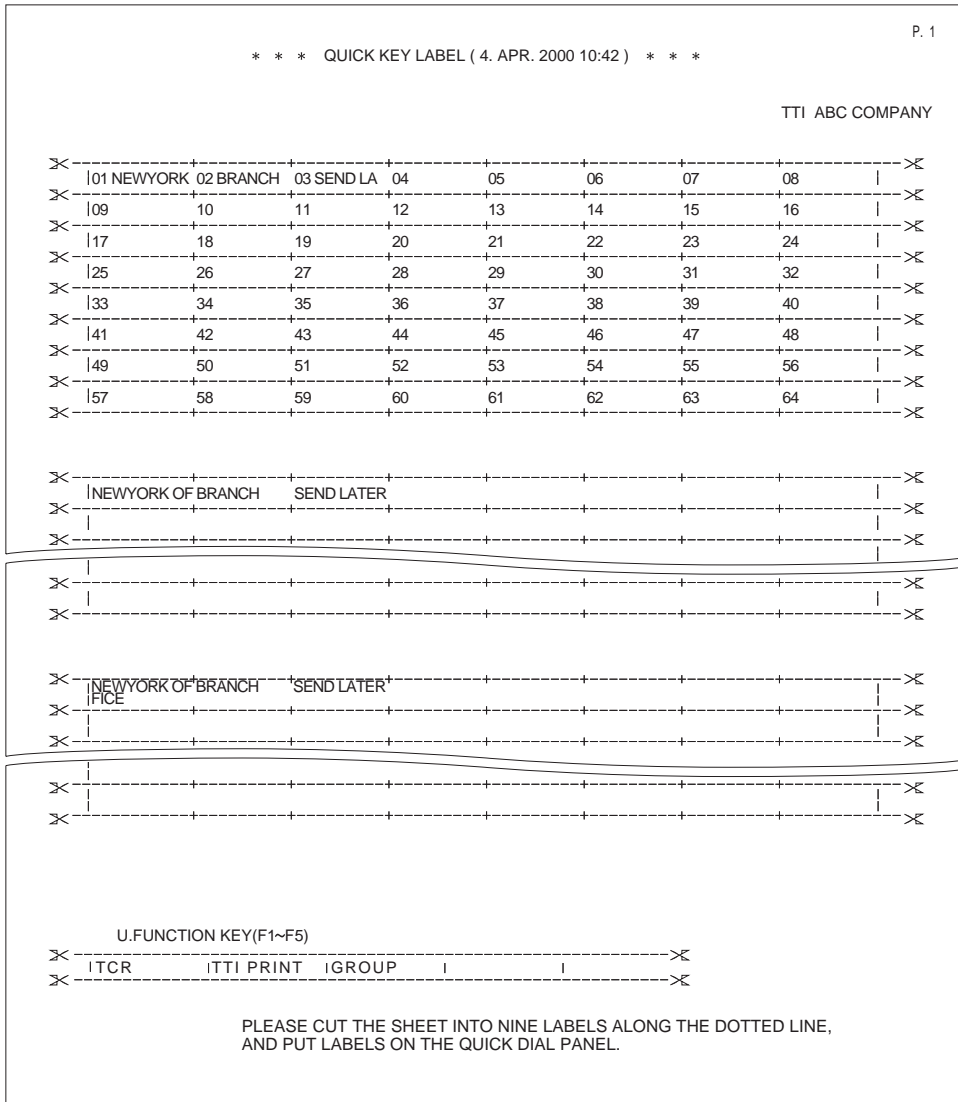

Deleting Quick Dials

This procedure describes how to find a programmed Quick Dial and delete it.

! Limitation

☐ When a Quick Dial key is being used for a standby Memory Transmission, the message "Already used in other file. Cannot be deleted." is shown and you cannot delete the destination for this key.

1 Make sure that the machine is in standby mode.

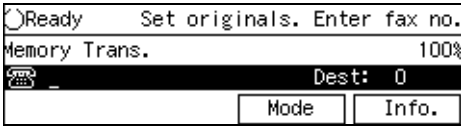

Note

- ❑ If the “Fax Features” or “Key Op. Tools” screen is shown, press the **[User Tools]** key. If any other display is shown, press the **[Clear Modes/Energy Saver]** key.

2 Press the **[User Tools]** key.

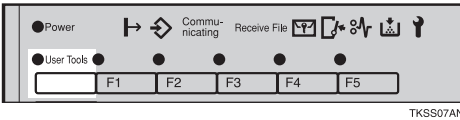

3 Enter the code for “Fax Features” with the number keys.

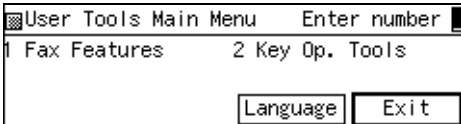

The “Fax Features” menu appears.

4 Enter the code for “Program/Delete” with the number keys.

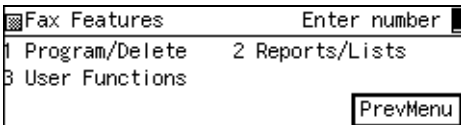

5 Enter the code for “Delete Quick Dial” using the number keys.

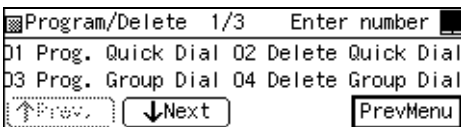

6 Press the Quick Dial key which you want to delete.

The current contents of the key are displayed.

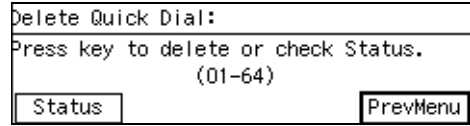

Note

- ❑ If you press the wrong key, press **[No]** then try again.
- ❑ You can press **[Status]** to see Quick Dial keys that have been already programmed.

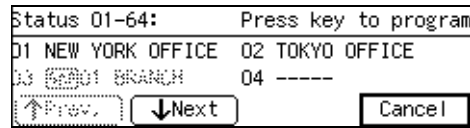

7 Press **[Yes]**.

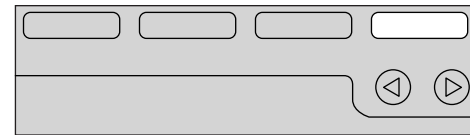
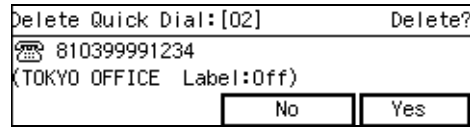

Note

- ❑ If you press **[No]**, the destination is not deleted and the display is shown in step 6 appears again.

8 Press **[Yes]** to delete the destination stored in this Quick Dial.

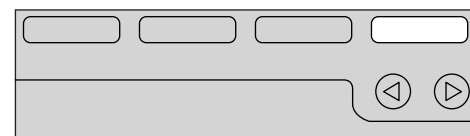
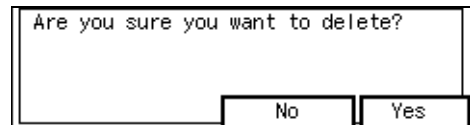

 **Note**

- If you press [No], the destination is not deleted and the display shown in step 8 appears again.

9 Press [PrevMenu] three times.

10 Press [Exit] to return to standby mode.

Registering Groups

If you send the same message to several destinations at the same time on a regular basis, program these destination numbers as a Group. This allows you to dial these destinations with a single key press.

Follow the procedure below to program a new Group or edit/overwrite an existing Group.

You can register the following items in a Group:

- Destination fax numbers (up to 250 numbers for each group, up to 254 digits for each number)
- Group name (up to 20 characters)

You can enter destination numbers with Quick Dial keys, Speed Dials, or the number keys.

Whether or you choose to store a Group in a Quick Dial key will affect how you specify the Group when dialing:

- If you have stored the Group in a Quick Dial key, press the Quick Dial key.
- If not stored in a Quick Dial key, press the User Function Key that has been registered beforehand as the Group key, then enter the Group number.

 **Important**

- It is recommend that you print the Group Dial list and keep it when you register or change destinations.⇒ P.223 "Reports/Lists"

 **Limitation**

- You can register up to 9 Groups (30 Groups when the optional function expander card is installed).
- The maximum number of destination you can register in a Group is 250.
- The combined maximum number of destinations you can register in all Groups is 264. This 264 can be composed of up to 64 Quick Dial numbers, 100 Speed Dial numbers and 100 numbers entered directly with the number keys.
- Installing the optional Function Upgrade Card expands the number of destinations you can specify:
 - With the number keys: 1,000 destinations
 - With Speed Dials: 1,000 destinations
 - This gives a combined maximum of 2064 destinations.
- The number of destinations that can be registered with the number keys depends on how the machine is used. In theory you can register up to a combined maximum of 100 destinations with the number keys for all Groups. However, since if you register 100 items with the number keys Memory Transmission becomes unavailable, only register up to 99 items with the number keys.

- ❑ If you register the same destination more than once with a Speed Dial or Quick Dial in a Group, it is only counted as one item. However, if you register two or more identical destinations with the number keys they will be counted as two or more items. If all destinations are different, you may not be able to store 250 destinations in a Group.
- ❑ When a registered group is being used for a standby Memory Transmission, the message “Already used in other file. Cannot be changed.” is shown and you cannot change destinations for this Group.

1 Make sure that the machine is in standby mode.

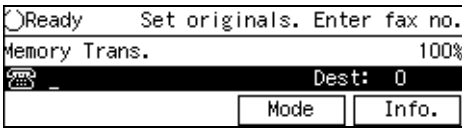

Note

- ❑ If the “Fax Features” or “Key Op. Tools” screen is shown, press the [User Tools] key. If any other display is shown, press the [Clear Modes/Energy Saver] key.

2 Press the [User Tools] key.

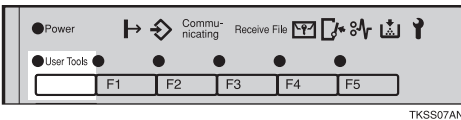

3 Enter the code for “Fax Features”.

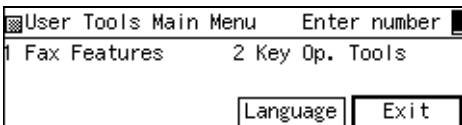

The “Fax Features” menu appears.

4 Enter the code for “Program/Delete” using the number keys.

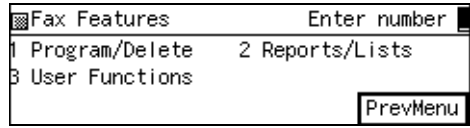

5 Enter the code for “Prog. Group Dial” using the number keys.

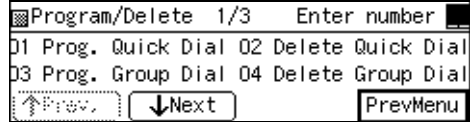

6 Enter the number of the Group you wish to register with the number keys.

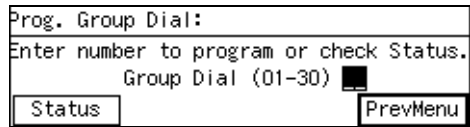

Note

- ❑ If you make a mistake, press [Cancel] then try again.
- ❑ You can press [Status] to see which Groups are currently programmed.

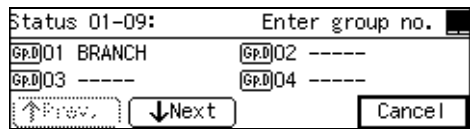

7 Press ⏪ or ⏩ to select “Normal”.

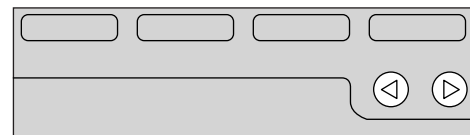
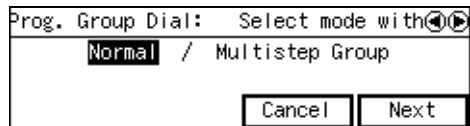

8 Press [Next].

9 Enter the destination fax number in one of the following ways:

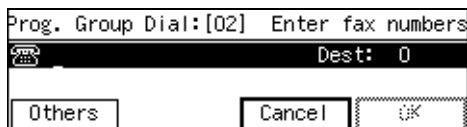

Note

Enter a destination in any of the following three ways:

- Enter the fax number using the number keys.
- Press a Quick Dial key in which the destination is registered.
- Press the **[Speed Dial]** key and enter a Speed Dial code.

If you make a mistake, press the **[Clear]** key and re-enter the correct Group number.

If destinations are already registered, they are shown on the display. Press the **[Left]** or **[Right]** key to scroll through the destinations on the display. If you want to change a destination, select it and press the **[Clear]** key. Press the **[Clear]** key once to erase a Quick Dial or Speed Dial number, or press it repeatedly to erase a number entered with the number keys. When you specify the destination using the number keys, the digit will be erased one by one. When using Quick dial or Speed dial, they will be erased at once.

You cannot omit the fax number.

Choosing the line (the **[Line Selection]** key)

1 Press the **[Line Selection]** key to select the line.

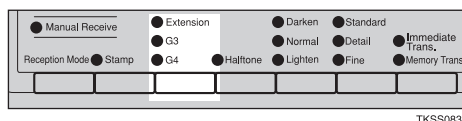

Choosing the line (the User Function key)

1 Press the User Function key (F1-F5) registered with the Line Select function.

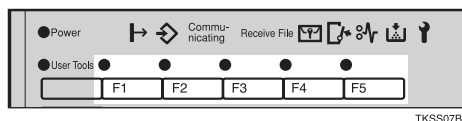

2 Press **[Left]** or **[Right]** to select the line.

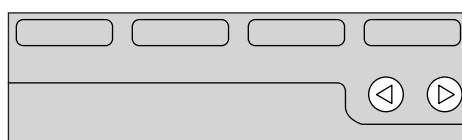
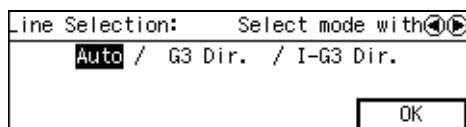

3 Press **[OK]**.

10 Press **[Add]**.

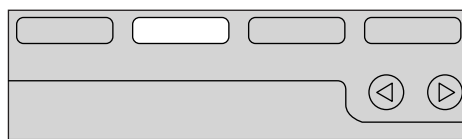
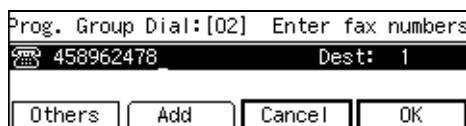

Note

- ❑ Each time after you press **[Add]** you can specify another destination.

11 Press [Others].

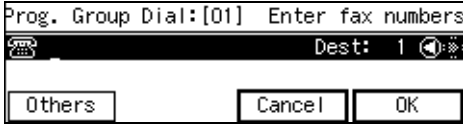

Registering/Editing the Group Name

1 Enter the code for "Group Name".

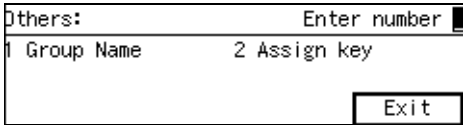

2 Enter the Group name.

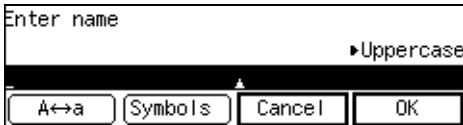

Note

- ❑ If the name is already stored, it will be shown on the display. To change it, press **[Clear]** and enter another name.

Reference

P.319 "Entering and Modifying Text"

3 Press [OK].

4 Press [Exit].

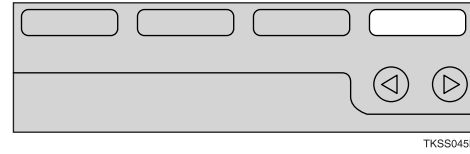
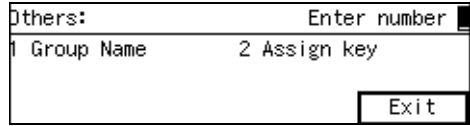

Assigning a Quick Dial key

1 Enter the code for "Assign key" with the number keys.

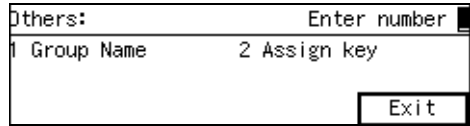

2 Press the Quick Dial you wish to assign this Group into.

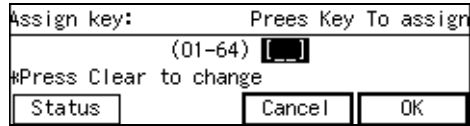

Note

- ❑ To search for a free Quick Dial, press **[Status]**.
- ❑ If you make a mistake, press the **[Clear]** key and try again.

3 Press [OK].

Note

- ❑ If you press **[Cancel]**, the Group will not be assigned to the Quick Dial key and the display in step **1** will reappear.

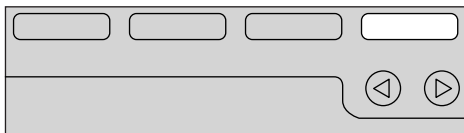
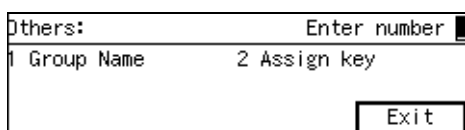
4 Press [Exit].

TKSS045N

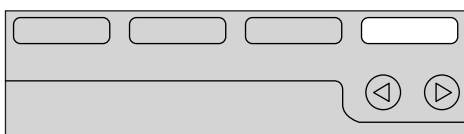
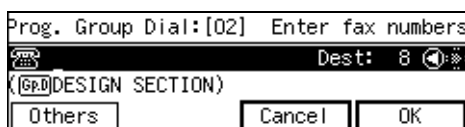
12 Press [OK].

TKSS045N

Note

- Press \leftarrow or \rightarrow to switch between destinations. To edit a destination, make sure the destination is displayed, then press the [Clear] key. When a destination was entered on the number keys, fax number digits are deleted one at a time. When the destination was entered using a Quick Dial or Speed Dial, pressing the [Clear] key once erases the whole destination.
- If you press [Cancel], the Group will not be registered and the display shown in step 6 will reappear.

13 Press [PrevMenu] three times.**14** Press [Exit] to return to standby mode.**Multi-step Transfer Group settings**

This procedure describes how to store a transfer station in a Group. Once set up, this machine can then forward incoming transfer requests that specify this Group onto the stored transfer station. The destination stored in the Group becomes the receiving station (in this case, store 30 or less items in the Group). Messages sent via multiple transfer stations further enhance the efficiency of the Transfer Request feature.

Note

- For more details, please contact your service representative.

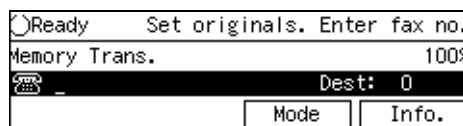
1 Make sure that the machine is in standby mode.**Note**

- If the “Fax Features” or “Key Op. Tools” screen is shown, press the [User Tools] key. If any other display is shown, press the [Clear Modes/Energy Saver] key.

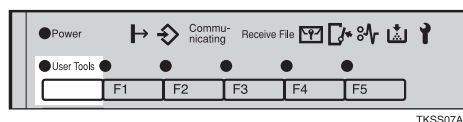
2 Press the [User Tools] key.

TKSS07AN

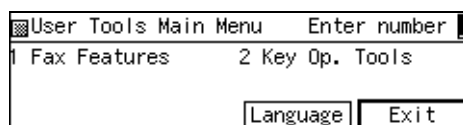
3 Enter the code for “Fax Features” with the number keys.

4 Enter the code for “Program/Delete” with the number keys.

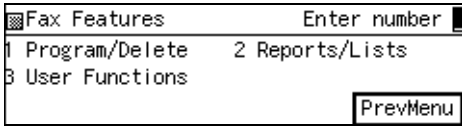

5 Enter the code for “Prog. Group Dial” with the number keys.

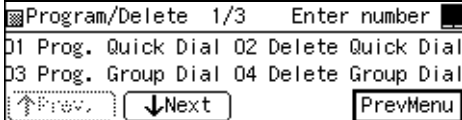

Note

- If the item you require is not displayed, press [**↑Prev.**] or [**↓Next**] until it is.

6 Enter the number of the Group you wish to register or edit with the number keys.

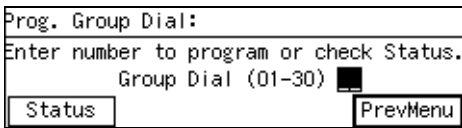

To Check On Currently Registered Groups

- 1** Press [**Status**].
- 2** Enter the number of the Group you wish to register or edit.

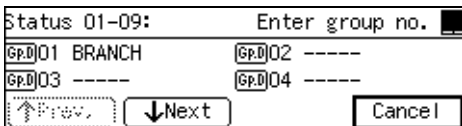

Note

- If a free Group is not displayed, press [**↑Prev.**] or [**↓Next**] to search for one.
- If you press [**Cancel**], the display in step **6** reappears.

7 Press **⏪** or **⏩** to select “Multistep Group”.

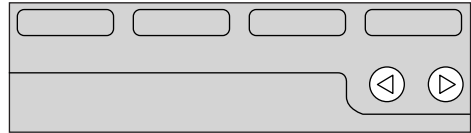

TKSS046N

8 Press [**Next**].

9 Specify the transfer station.



Note

- You can enter the transfer station fax number using a Quick Dial, a Speed Dial or the number keys. ⇒ P.88 “Dialing with Quick Dials”, ⇒ P.88 “Dialing with Speed Dials”, ⇒ P.81 “Number Keys”
- If the optional G4 Unit or the optional G3 Unit is installed, you can choose which line to use before you enter the fax number.
- If you make a mistake, press the [**Clear**] key and try again.
- If you press [**Cancel**], the transfer station will not be registered and the display in step **9** will reappear.

Choosing the line (the [Line Selection] key)

- 1 Press the [Line Selection] Key to select the line.

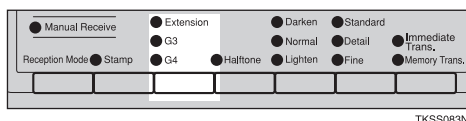

TKSS083N

Choosing the line (the User Function key)

- 1 Press the User Function key with the Line Select function stored in it.

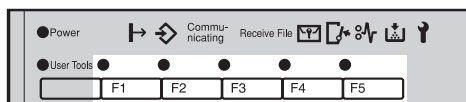

TKSS078N

- 2 Press [Left Arrow] or [Right Arrow] to select the line.

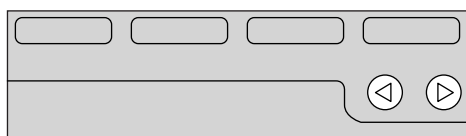
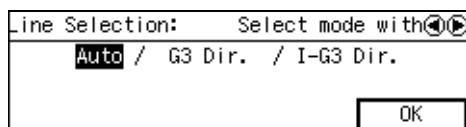

TKSS046N

- 3 Press [OK].

- 10 Press [Recv. Stn].

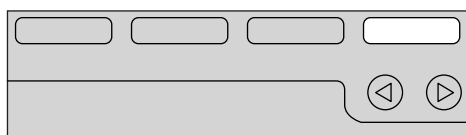

TKSS045N

- 11 Specify the end receiver in one of the following ways.

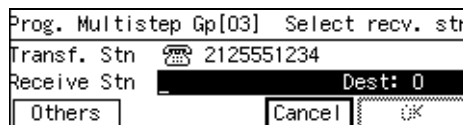

Note

- Specify the transfer station Quick Dial, Speed Dial or Group with the end receiver stored in it.
- The destination specified as the end receiver is passed to the transfer station and sent to the number stored in the transfer station.

Specifying an End Receiver Stored in a Quick Dial

- 1 Press [#] then enter the number of the Quick Dial (2 digits).

Note

- E.g. if the destination is stored in the transfer station's [Quick Dial 01], enter [#][0][1].
- To specify another end receiver, press [Add RcvStn].
- If you press [Left Arrow] or [Right Arrow], you can view and check end receivers already stored. To delete the displayed end receiver, press the [Clear] key.
- To cancel this Transfer Request, press [Cancel].

Specifying an End Receiver Stored in a Speed Dial

- 1 Press [#][*] then enter the Speed Dial code (2 digits).

Limitation

- ❑ You can only specify Speed Dial codes in the range 00-99.

Note

- ❑ E.g. if the destination is stored in the transfer station's Speed Dial 12, enter **#[*][1][2]**.
- ❑ To specify another end receiver, press **[Add RcvStn]**
- ❑ If you press **⏪** or **⏩**, you can view and check end receivers already stored. To delete the displayed end receiver, press the **[Clear]** key.
- ❑ To cancel this Transfer Request, press **[Cancel]**.

Specifying an End Receiver Stored in a Group

- 1 Press **#[*][*]** then enter the Group number (2 digits).

Note

- ❑ E.g. if the destination is stored in the transfer station's Group 04, enter **#[*][*][0][4]**.
- ❑ To specify another end receiver, press **[Add RcvStn]**.
- ❑ If you press **⏪** or **⏩**, you can view and check end receivers already stored. To delete the displayed end receiver, press the **[Clear]** key.
- ❑ To cancel this Transfer Request, press **[Cancel]**.

12 Press [Add RcvStn].

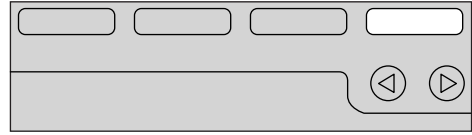
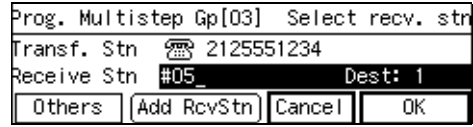

TKSS045N

13 Specify the remaining the end receivers in the same way.

14 Press [Others].

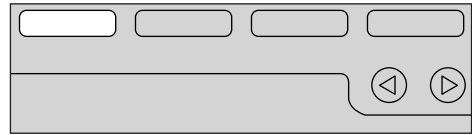

TKSS042N

Registering/Editing the Group Name

- 1 Enter the code for "Group Name" with the number keys.

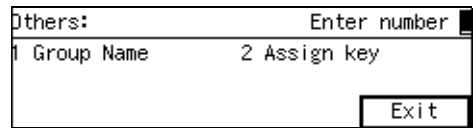

2 Enter the Group name.

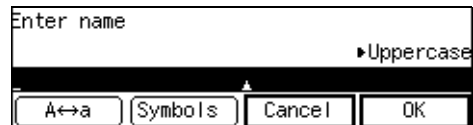

Note

- ❑ If the name is already stored, it will be shown on the display. To change it, press **[Clear]** and enter another name.

Reference

P.319 "Entering and Modifying Text"

3 Press [OK].

4 Press [Exit].

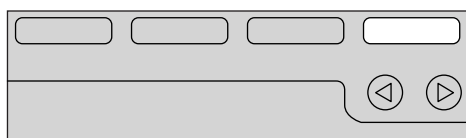
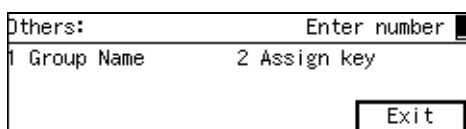

TKSS045N

4 Press [Exit].

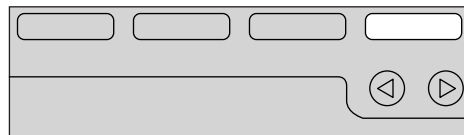
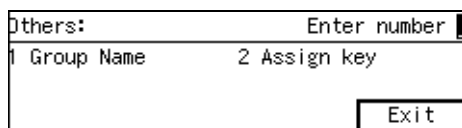

TKSS045N

15 Press [OK]

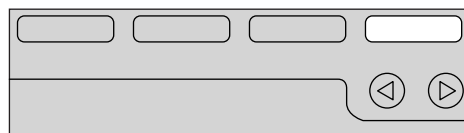
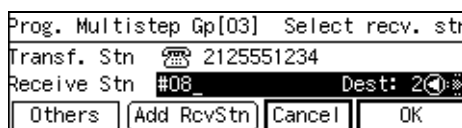

TKSS045N

Storing the Group in a Quick Dial

1 Enter the code for "Assign key" with the number keys.

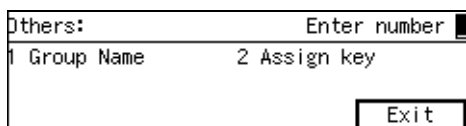

2 Press the Quick Dial key you wish to store the Group in.

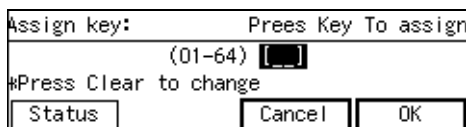

Note

- ❑ To search for a free Quick Dial, press **[Status]**.
- ❑ If you make a mistake, press the **[Clear]** key and try again.

3 Press [OK].

Note

- ❑ If you press **[Left]** or **[Right]**, you can view and check already end receivers already stored.
- ❑ To delete the displayed end receiver, press the **[Clear]** key.
- ❑ To cancel this programming this Group, press **[Cancel]**.

16 Press [PrevMenu] three times.

17 Press [Exit] to return to standby mode.

Group Dial List

The Group list allows you to print and check destinations registered in Groups. ⇒ P.223 "Reports/Lists"

Deleting Groups

This function deletes all destinations registered in a Group.

⚠ Limitation

- ❑ When a registered Group is being used for a Memory Transmission on standby, the message “Already used in other file. Cannot be deleted.” is displayed and you cannot delete destinations for this Group.

- 1 Make sure that the machine is in standby mode.

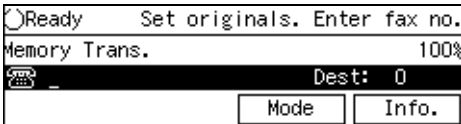

📝 Note

- ❑ If the “Fax Features” or “Key Op. Tools” screen is shown, press the [User Tools] key. If any other display is shown, press the [Clear Modes/Energy Saver] key.

- 2 Press the [User Tools] key.

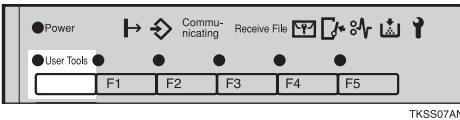

- 3 Enter the code for “Fax Features” with the number keys.

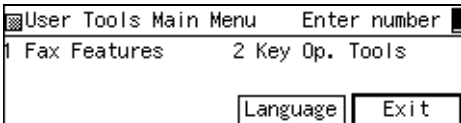

The “Fax Features” menu appears.

- 4 Enter the code for “Program/Delete”.

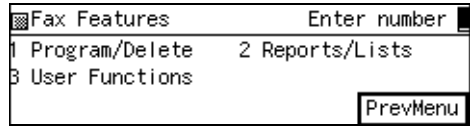

- 5 Enter the code for “Delete Group Dial” using the number keys.

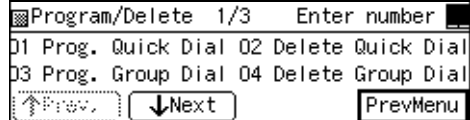

📝 Note

- ❑ If the item you require is not displayed, press [↑Prev.] or [↓Next] until it is.

- 6 Enter the number of the Group you wish to delete with the number keys.

The registered Group is shown on the display.

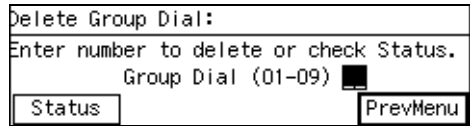

📝 Note

- ❑ If you make a mistake, press [No] and press the correct key.
- ❑ You can press [Status] to see Quick Dial keys are programmed with Group.

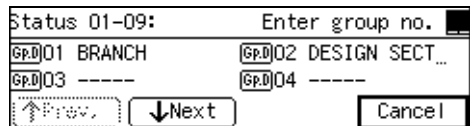

2 Press the **[User Tools]** key.

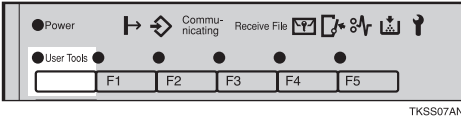

3 Enter the code for “Fax Features” using the number keys.

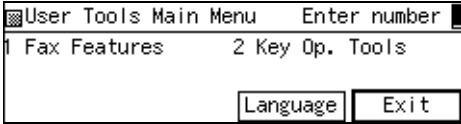

The “Fax Features” main menu appears.

4 Enter the code for “Program/Delete”.

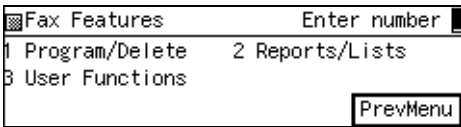

5 Enter the code for “ Prog. Speed Dial”.

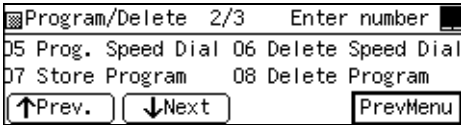

6 Enter the Speed Dial code you want to register using the number keys.

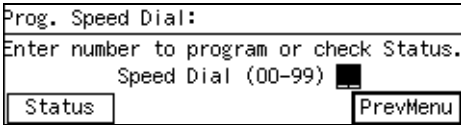

Note

- If you make a mistake, press the **[Clear]** key correct number.

- You can press **[Status]** to see which Speed Dials are programmed.



7 Enter a fax number using the number keys.

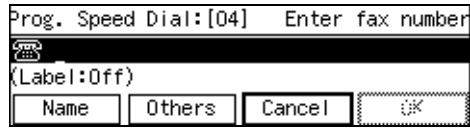

Note

- If a fax number is already registered in this Speed Dial, the number is shown on the display. If you wish to change the fax number, press the **[Clear]** key and enter another number.
- You cannot omit the fax number. Be sure to register it.
- When the optional G4 unit or optional G3 unit is installed, you can select which line to use (G3 or G4) before entering the fax number.
- If you make a mistake, press the **[Clear]** key or **[Stop]** key and try again. The **[Clear]** key deletes one character at a time, and the **[Stop]** key deletes the whole line.

Choosing the line (the **[Line Selection]** key)

1 Press the **[Line Selection]** key to select the line.

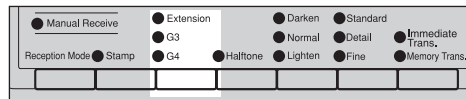

Choosing the line (the User Function key)

- 1 Press the User Function key (F1-F5) programmed with the Line Select feature.

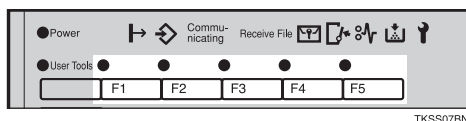

TKSS07BN

- 2 Press the ◀ or ▶ keys to select the line.

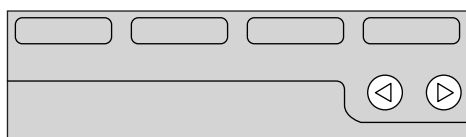
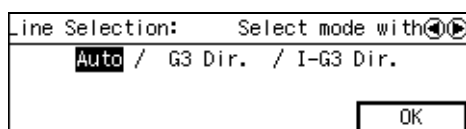

TKSS046N

- 3 Press [OK].

Assigning a name

- 1 Press [Name].
- 2 Enter the name.

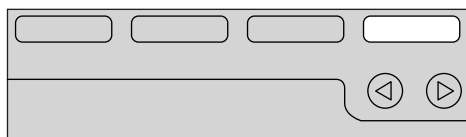
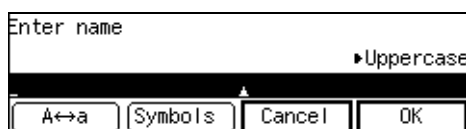

TKSS045N

Note

- If a Group name is already registered it is shown on the display. If you want to change the name. Press the [Clear] key and enter another name.

- If you register a name for a Speed Dial, the first letter is automatically selected at the Telephone Directory search letter. If you wish to select a different letter, choose the "Sp.Dial Tel. Dir." option and enter the letter.

- 3 Press [OK].

Turning Label Insertion on

- 1 Press [Others].
- 2 Enter the code for "Label Insertion" with the number keys.

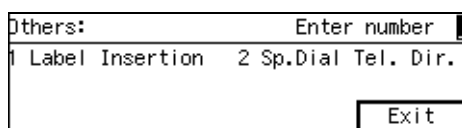

- 3 Press the ◀ or ▶ keys turn Label Insertion on.

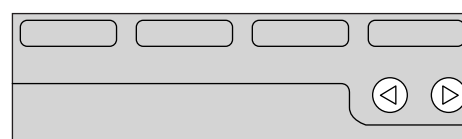
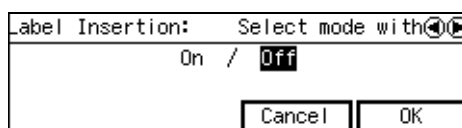

TKSS046N

- 4 Press [OK].
- 5 Press [Exit].

Specifying a search letter

- 1 Press [Others].
- 2 Enter the code for "Sp.Dial Tel. Dir." with the number keys.

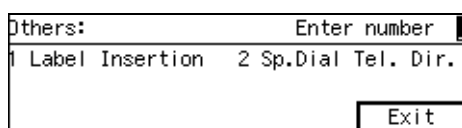

- 3 Press one of the Quick Dial keys to specify the Speed Dial search letter.

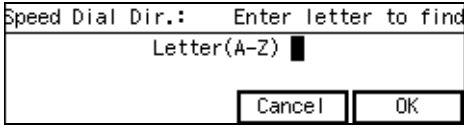

- 4 Press [OK].
- 5 Press [Exit].

- 8 Press [OK].

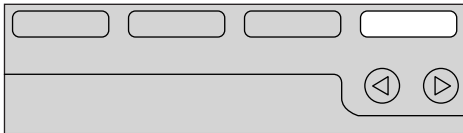
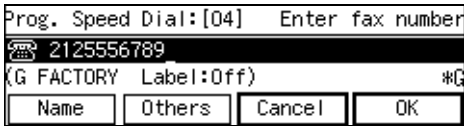

TKSS045N

Note

- If you press [Cancel], the setting you entered is deleted and the display in step 6 reappears.

- 9 Press [PrevMenu] three times.

- 10 Press [Exit] to return to standby mode.

Speed Dial List

Print this list to check which destinations are programmed.⇒ P.223 "Reports/Lists"

Deleting Speed Dials

Use this procedure to delete any Speed Dials you are not using anymore.

Limitation

- If a registered Speed Dial is being used for a standby Memory Transmission, the message "Already used in other file. Cannot be deleted." is shown and you cannot change the destination for this Speed Dial.

- 1 Make sure that the machine is in standby mode.

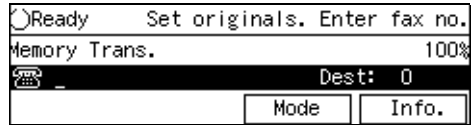

Note

- If the "Fax Features" or "Key Op. Tools" screen is shown, press the [User Tools] key. If any other display is shown, press the [Clear Modes/Energy Saver] key.

- 2 Press the [User Tools] key.

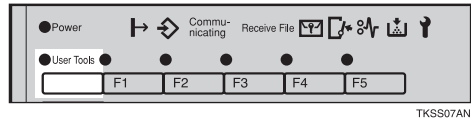

TKSS07AN

- 3 Enter the code for "Fax Features" with the number keys.

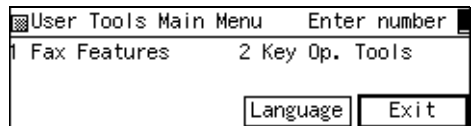

The "Fax Features" main menu appears.

- 4 Enter the code for "Program/Delete" with the number keys.

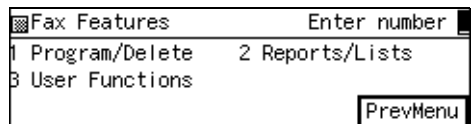

5 Enter the code for “Delete Speed Dial”.

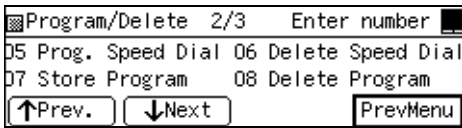

6 Enter the Speed Dial code you wish to delete with the number keys.

The registered destination is shown on the display.

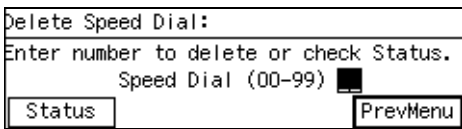

Note

- If you make a mistake before entering the first digit, press the **[Clear]** key and enter the correct number. If you make a mistake after entering the last digit, press **[No]** and enter the number again.
- You can press **[Status]** to see which Speed Dials are currently programmed.

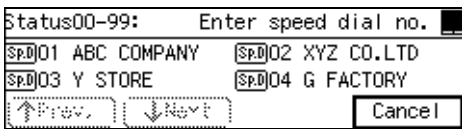

7 Press **[Yes]**.

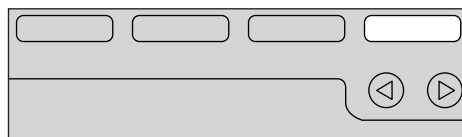
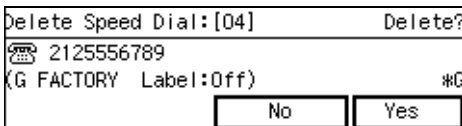

Note

- If you press **[No]**, the Speed Dial is not deleted and the display shown in **6** appears again.

8 Press **[Yes]**.

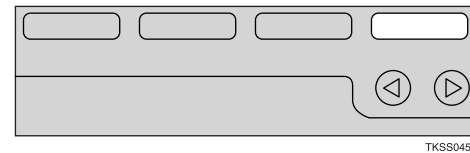
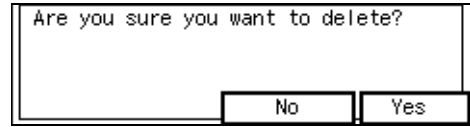

The Speed Dial is deleted.

Note

- If you press **[No]**, the Speed Dial is not deleted and the display shown in **6** appears again.

9 Press **[PrevMenu]** three times.

10 Press **[Exit]** to return to standby mode.

Storing Keystroke Programs

If you regularly send messages to a particular destination or transmit using the same features, you can save a lot of repetitive keypad operations by storing these settings in a Keystroke Program.

Keystroke Programs can then be recalled by just pressing a Quick Dial key. The following procedure can be used to program a new Keystroke Program or overwrite an old one.

You can register the following items in Keystroke Programs:

- Memory Transmission, Immediate Transmission, Confidential Transmission, Polling Transmission, Polling Reception, Transfer Request, Printing Report or List.
- Program name (up to 20 characters)

Important

- We recommend that you print the Keystroke Program list and keep it when you register or change a function. ⇒ P.223 “Reports/Lists”

Limitation

- The maximum number of programs you can register is 64 (164 when the optional Function Upgrade Card is installed).
- You cannot register a program in a Quick Dial key already used for another function.
- Keystroke Programs can only be stored in Speed Dials when the optional Function Upgrade Card is installed.

8

1 Make sure that the machine is in standby mode.

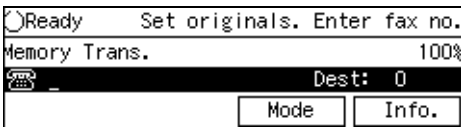

Note

- If the “Fax Features” or “Key Op. Tools” screen is shown, press the [User Tools] key. If any other display is shown, press the [Clear Modes/Energy Saver] key.

2 Press the [User Tools] key.

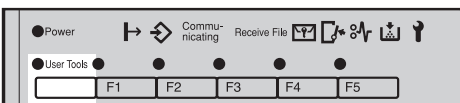

TKSS07AN

3 Enter the number of the “Fax Features” with the number keys.

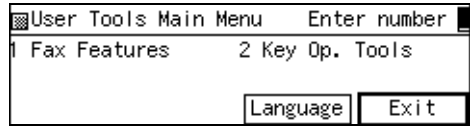

The “Fax Features” main menu appears.

4 Enter the code for “Program/Delete” using the number keys.

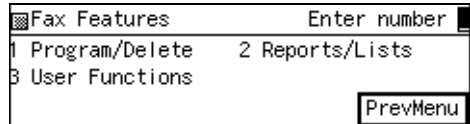

5 Enter the code for “Store Program” using the number keys.

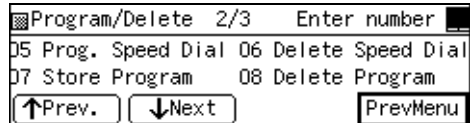

6 Press a Quick Dial key you want to register.

The “Store Program” display is shown.

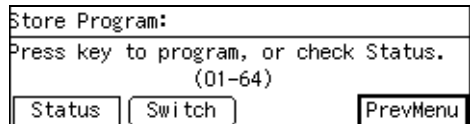

Storing the Program in a Quick Dial key

1 Press the Quick Dial key you wish to store the program in.

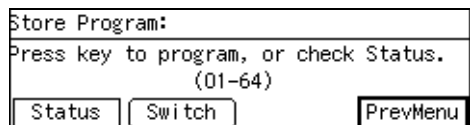

Note

- If you make a mistake, press [Cancel] and try again.

- To check which programs are currently stored, press **[Status]**.
- You can also select the Quick Dial to store the program in from the status screen.

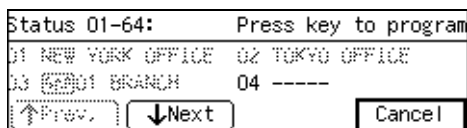

Storing the program in a Speed Dial

1 Press **[Switch]**.

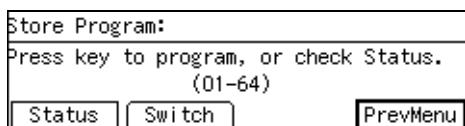

2 Enter the code of the Speed Dial you wish to store the program in.

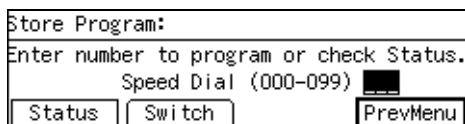

Note

- If you make a mistake, press **[Clear]** and try again.
- To check which programs are currently stored, press **[Status]**.
- You can also select the Speed Dial to store the program in from the status screen.

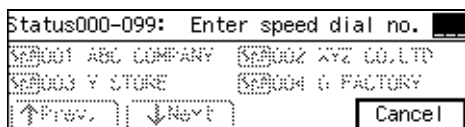

7 Press **[Feature]**.

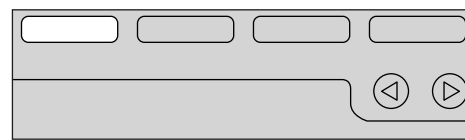
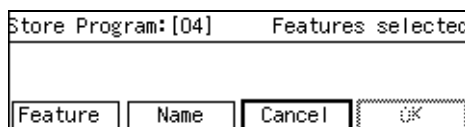

TKSS042N

8 Carry out the operations you wish to store in the program.

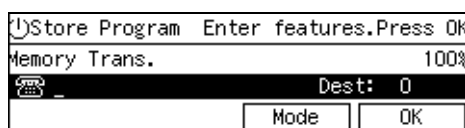

Note

- If you press the **[Clear Modes/Energy Saver]** key, the whole operation is canceled.
- For example, say you wish to use Send Later to destination number 0123456789. The sequence of operations would be:
 - Enter “0123456789” using the number keys.
 - Press **[Mode]**.
 - Enter the code for “Send Later” using the number keys.
 - Set Send Later.

9 Press **[OK]**.

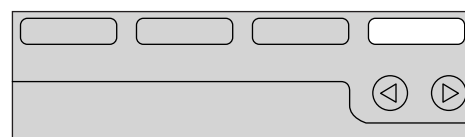
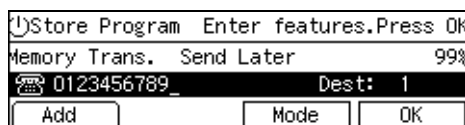

TKSS045N

10 Press **[Name]**.

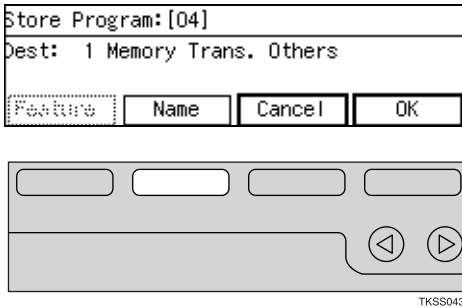

TKSS043N

11 Enter the program name.

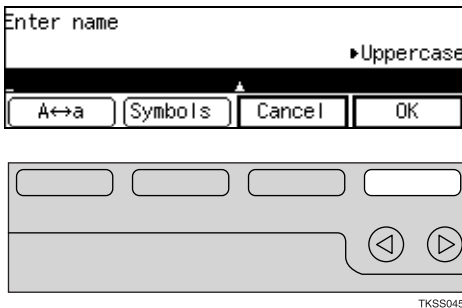

TKSS045N

Note

- ❑ If a program name is already registered in the Quick Dial key, the name is shown on the display. If you wish to change the program name, press the **[Clear]** key and enter another name.

Reference

P.319 "Entering and Modifying Text"

12 Press **[OK]**

The function name and program name are shown on the display.

13 Press **[OK]**.

The program is stored.

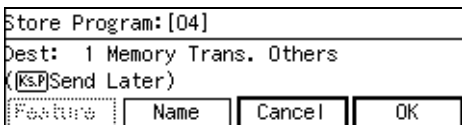

Note

- ❑ If you press **[Cancel]**, the Keystroke Program is canceled and the display shown in step **9** appears again.

14 Press **[PrevMenu]** three times.

15 Press **[Exit]** to return to standby mode.

Using a Keystroke Program

Example: Recalling a program containing fax number "0123456789" and the Send Later function.

1 Set your document.

Note

- ❑ If the destination, resolution, contrast and/or halftone are not registered in the program, carry out these operations now.

2 Select the Quick Dial or Speed Dial with the program stored in it by pressing the Quick Dial key, or pressing the Speed Dial key and entering the Speed Dial code.

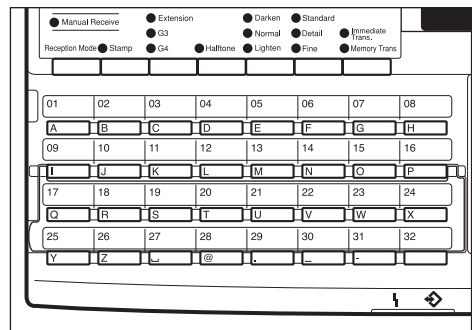

TKSS050N

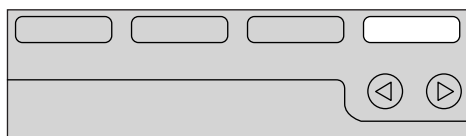
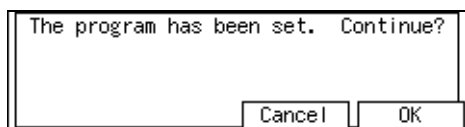
3 Press [OK].

TKSS045N

4 Press the [Start] key.

The machine starts scanning the document.

The message will be sent at the specified time.

Keystroke Program List

The Keystroke Program list allows you to print and check functions registered in keystroke programs.⇒ P.223 "Reports/Lists"

Deleting a Keystroke Program

Note

- If you delete a program, the registered program name is also deleted.

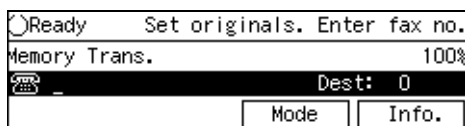
1 Make sure that the machine is in standby mode.**Note**

- If the "Fax Features" or "Key Op. Tools" screen is shown, press the [User Tools] key. If any other display is shown, press the [Clear Modes/Energy Saver] key.

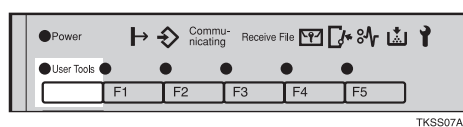
2 Press the [User Tools] key.

TKSS07AN

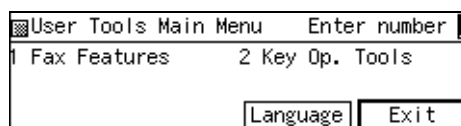
3 Enter the code for "Fax Features" with the number keys.

The "Fax Features" main menu appears.

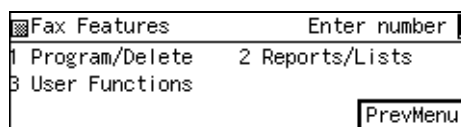
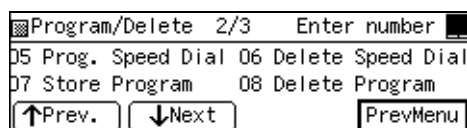
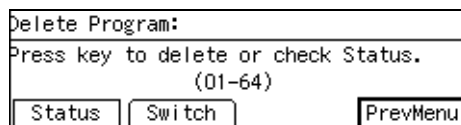
4 Enter the code for "Program/Delete" with the number keys.**5** Enter the code for "Delete Program" with the number keys.**6** Press a Quick Dial key, or press [Switch] and enter a Speed Dial code.

The contents of the program are shown on the display.

Note

- If you make a mistake, press [No] and the correct key.

- ❑ If you wish to delete a Keystroke Program stored in a Speed Dial, press **[Switch]**. Then press the **[Speed Dial]** key and enter the Speed Dial code.



- ❑ You can press **[Status]** to see the Keystroke Programs currently programmed.

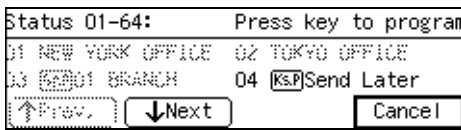

7 Press **[Yes]**.

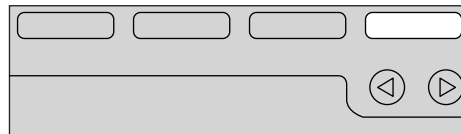
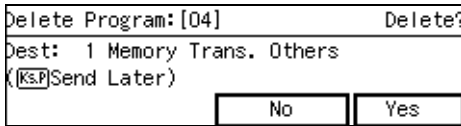

TKSS045N

Note

- ❑ If you press **[No]**, the program is not deleted and the display shown in step **6** appears again.

8 Press **[Yes]**.

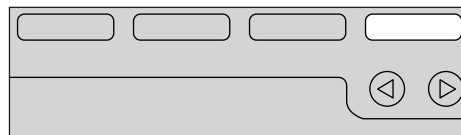
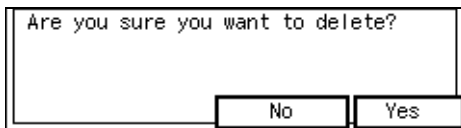

TKSS045N

The program is deleted.

Note

- ❑ If you press **[No]**, the program is not deleted and the display shown in step **6** appears again.

9 Press **[PrevMenu]** three times.

10 Press **[Exit]** to return to standby mode.

Registering Auto Documents

If you find that you often have to send a particular page to people (e.g., a map, a standard attachment, or a set of instructions), store that page in memory as an Auto Document. This saves re-scanning the document every time you wish to send it.

Use the following procedure to program a new Auto Document or overwrite an existing one.

Important

- ❑ You can store the following items in an Auto Document:

- Document image
- Scan settings (Resolution, half-tone, and Image Density)
- Document name (up to 20 characters)
- Label Insert Size

Limitation

- ❑ You can only send one Auto Document per transmission.
- ❑ You can store up to 64 Auto Documents (164 when the optional Function Upgrade Card is installed).
- ❑ Auto Documents can only be stored in Speed Dials when the optional Function Upgrade Card is installed.

- 1 Make sure that the machine is in standby mode.

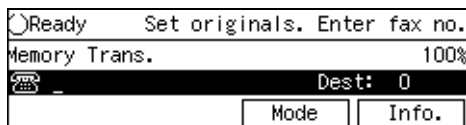

Note

- If the "Fax Features" or "Key Op. Tools" screen is shown, press the [User Tools] key. If any other display is shown, press the [Clear Modes/Energy Saver] key.

- 2 Press the [User Tools] key.

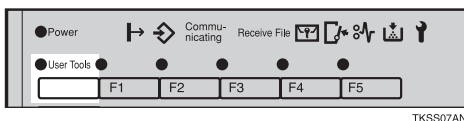

- 3 Enter the code for "Fax Features" using the number keys.

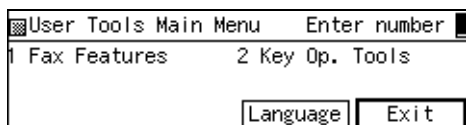

The "Fax Features" main menu appears.

- 4 Enter the code for "Program/Delete" with the number keys.

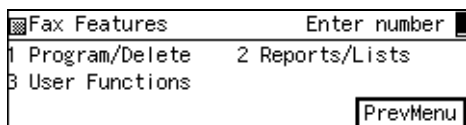

- 5 Enter the code for "Prog. Auto Doc." with the number keys.

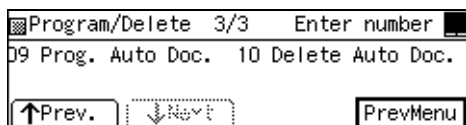

- 6 Do one of the following:

To store an Auto Document in a Quick Dial key

- 1 Press the Quick Dial key that you wish to store the Auto Document in.

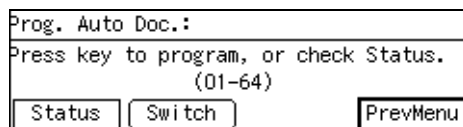

Note

- If you make a mistake, press [Cancel] and try again.
- Press [Status] to check the documents currently stored.

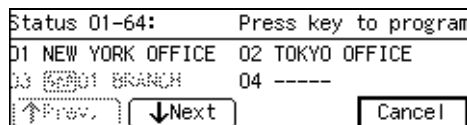

To store an Auto Document in a Speed Dial

- 1 Press [Switch].

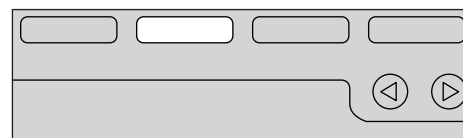
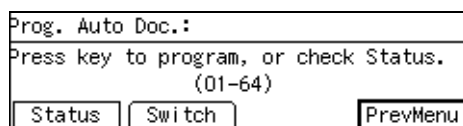

- 2 Enter the Speed Dial code of the Speed Dial you wish to store the Auto Document in.

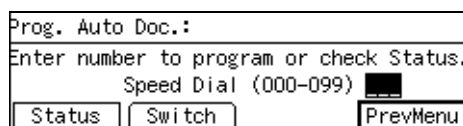

Note

- If you make a mistake, press [Cancel] and try again.

- Press **[Status]** to check the documents currently stored.
- You can also select the Speed Dial to store the Auto Document in from the status screen.



7 What you do next depends one whether the Quick Dial or Speed Dial has a destination already registered. Choose one of the following two procedures:

When the destination is not registered

1 Press **[Name]**.

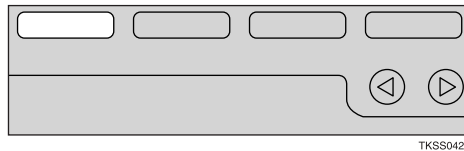
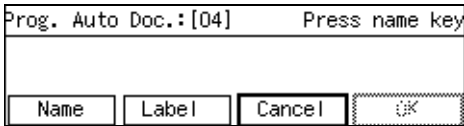

TKSS042N

2 Enter the name.

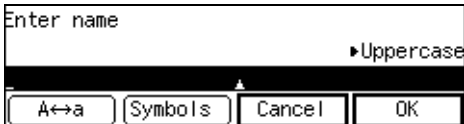

Reference

P.319 "Entering and Modifying Text"

3 Press **[OK]**.

4 Press **[Label]**.

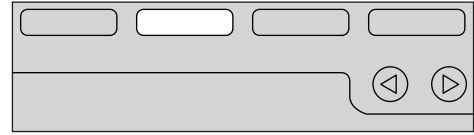
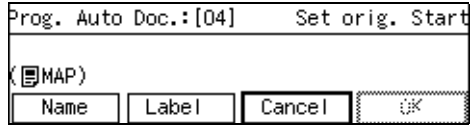

TKSS043N

5 Press **⏪** or **⏩** to select "Large (1x2)" or "Normal".

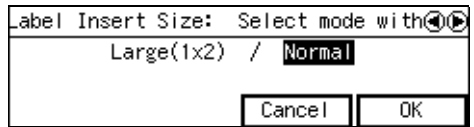

6 Press **[OK]**.

When the destination is registered

1 Press **[Label]**.

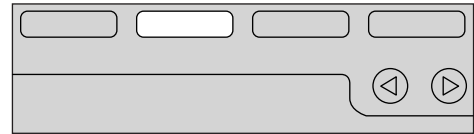
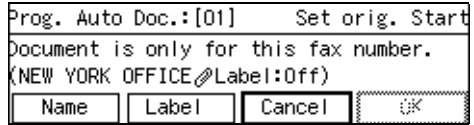

TKSS043N

2 Press **⏪** or **⏩** to select "Large (1x2)" or "Normal".

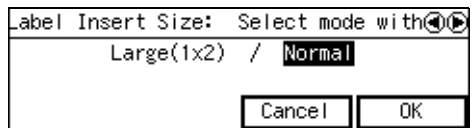

3 Press **[OK]**.

8 Set your document.

9 Press the **[Start]** key to scan in the document.

When scanning has finished, the Auto Document is stored.

- 10 Press [PrevMenu] three times.
- 11 Press [Exit] to return to the standby mode.

Deleting an Auto Document

Limitation

- You cannot delete an Auto Document waiting to be transmitted. Delete it after the transmission, or delete the Auto Document after deleting the file waiting to be transmitted.

- 1 Make sure that the machine is in standby mode.

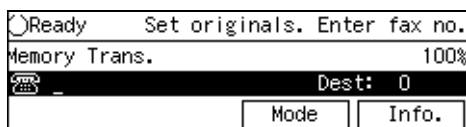

Note

- If the “Fax Features” or “Key Op. Tools” screen is shown, press the [User Tools] key. If any other display is shown, press the [Clear Modes/Energy Saver] key.

- 2 Press the [User Tools] key.

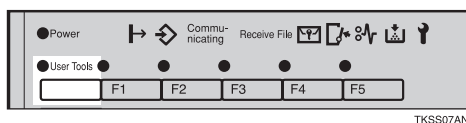

TKSS07AN

- 3 Enter the code for “Fax Features” using the number keys.

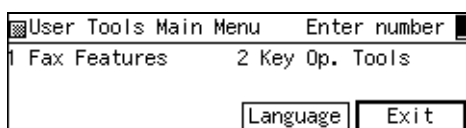

The “Fax Features” main menu appears.

- 4 Enter the code for “Program/Delete” with the number keys.

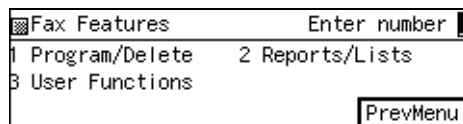

- 5 Enter the code for “Delete Auto Doc.” with the number keys.

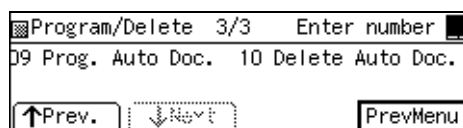

- 6 Press a Quick Dial key, or press [Switch] and enter a Speed Dial code.

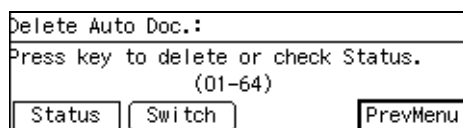

The stored document is shown on the display.

Note

- If you wish to delete a stored in a Speed Dial, press [Switch]. Then press the [Speed Dial] key and enter the Speed Dial code.

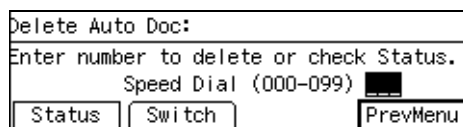

Checking On Stored Auto Documents

- 1 Press [Status].

- 2 Scroll through the list with [↑Prev.] or [↓Next].

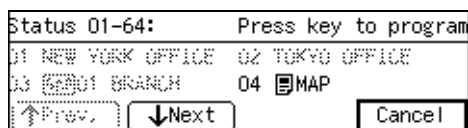

Note

- If you press [Cancel], the display in step 6 appears.

- 7 Press [Yes].

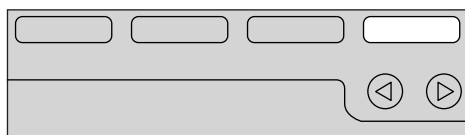
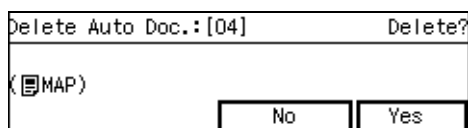

TKSS045N

Note

- If you press [No], the Auto Document is not deleted and the display shown in step 6 reappears.

- 8 Press [Yes] to delete the Auto Document.

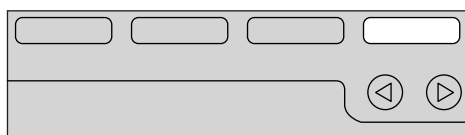
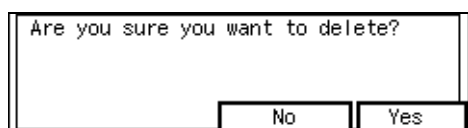

TKSS045N

Note

- If you press [No], the Auto Document is not deleted and the display shown in step 6 reappears.

- 9 Press [PrevMenu] three times.

- 10 Press [Exit] to return to standby mode.

Reports/Lists

This function allows you to print the following reports and lists manually. Select a report or list as needed.

- Journal ⇒ P.156
- Quick Dial list/Quick Key Label ⇒ P.196, ⇒ P.196
- Group Dial list ⇒ P.207
- Speed Dial list ⇒ P.212
- Keystroke Program list ⇒ P.217
- Auto Document ⇒ P.98, ⇒ P.218

1 Make sure that the machine is in standby mode.

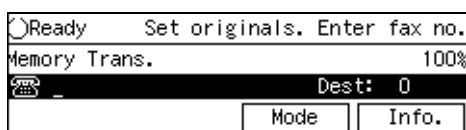

Note

- If the “Fax Features” or “Key Op. Tools” screen is shown, press the **[User Tools]** key. If any other display is shown, press the **[Clear Modes/Energy Saver]** key.

2 Press the **[User Tools]** key.

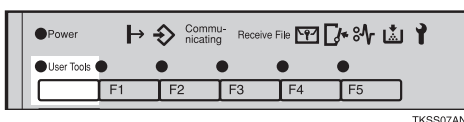

3 Enter the number of the “Fax Features” using the number keys.

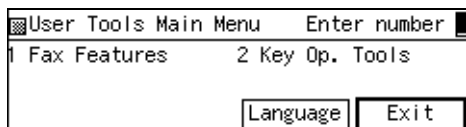

The “Fax Features” main menu appears.

4 Enter the code for “Reports/Lists” with the number keys.

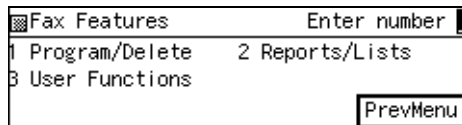

5 Enter the code of the report or list you wish to print.

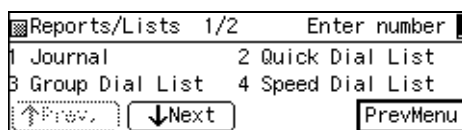

Note

- If you can't see the item you need, press **[↑Prev.]** or **[↓Next]**.
- If you make a mistake, press **[Cancel]** and enter the correct number.
- After selecting “Journal”, choose “All”, “File No.”, “Personal Code” or “Date”.
- After selecting “Quick Dial List” choose “Quick Dial List” or “Dial Label”.
- After selecting “Speed Dial List” choose “Speed Dial Order” or “Alphabetic Order”.

6 Press the **[Start]** key.

When printing is completed, the display shown in step **5** appears again.

Note

- If you press the **[Stop]** key before printing starts, the printing stops and the display shown in step **5** appears again.

7 Press **[PrevMenu]** twice.

8 Press [Exit] to return to standby mode.

Assigning User Function Keys

You can program each of the User Function keys ([F1]–[F5]) with a function that you use frequently. When you wish to use that function, instead of having to search through several menus to find it, just press the appropriate User Function key. This procedure can be used to edit, delete or change the contents of the User Function keys.

Note

- At default the following functions are programmed by default.

Key	Standard
F1	Journal Print
F2	TTI Print
F3	Specify Group Number
F4	-
F5	-

Registering/Editing the Contents of a User Function Key

- Make sure that the machine is in standby mode.

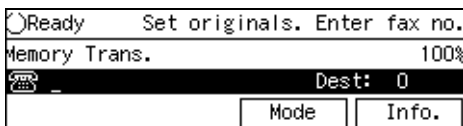

Note

- If the “Fax Features” or “Key Op. Tools” screen is shown, press the [User Tools] key. If any other display is shown, press the [Clear Modes/Energy Saver] key.

- Press the [User Tools] key.

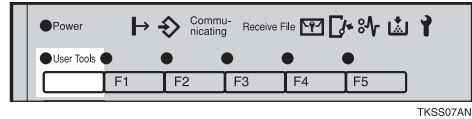

- Enter the number of the “Fax Features”.

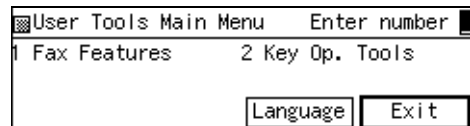

The “Fax Features” main menu appears.

- Enter the code for “User Functions” using the number keys.

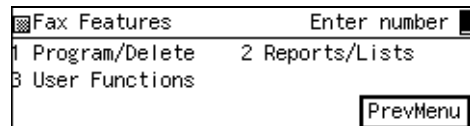

- Press the User Function key you want to use.

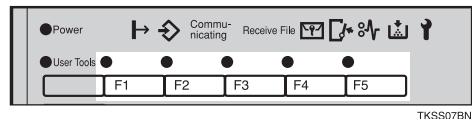
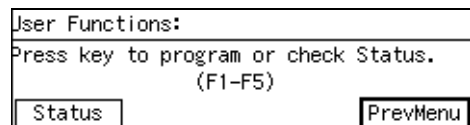

Note

- If you make a mistake, press [Cancel] and press the correct key.

- ❑ You can press **[Status]** to see how the User Function keys are currently programmed.

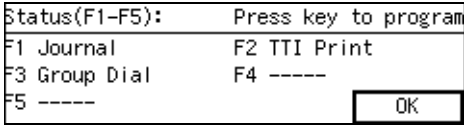

- Enter the code you want to register into the User Function key using the number keys and press **[OK]**.

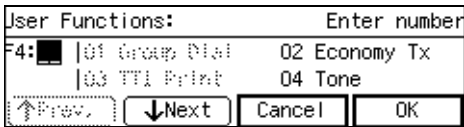

Note

- ❑ To see a function number not displayed on the display, press **[↑Prev.]** or **[↓Next]**.
- ❑ If you wish to store more functions, repeat steps **5** and **6** for other keys.
- ❑ If you press **[Cancel]**, the function is not stored and the display shown in step **5** appears again.
- ❑ If another function is already registered, press the **[Stop]** key to delete it.

- Press **[PrevMenu]** twice.

- Press **[Exit]** to return to standby mode.

Programming a User Function Key on the Job

When carrying out an operation from the operation panel, you can store the various operations that you have performed so far in a User Function key. Once stored, just press that User Function key when the standby display is shown to carry out those operations.

Limitation

- ❑ You cannot store the following operations in User Function keys:
 - User Function settings
 - Quick Dial, Speed Dial, Group Number, File No, Confidential ID, Memory Lock ID, or Operations carried out after specifying a Personal Code (SUB code).

The following example procedure describes how to store the time setting for Send Later in User Function key **[F5]**.

- Press **[Mode]**.

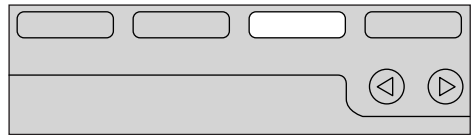
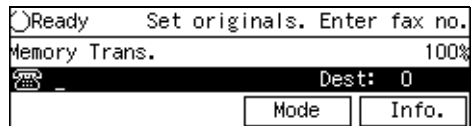

- Enter the code for "Send Later" with the number keys.

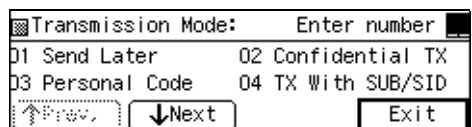

3 Press **[F5]**.

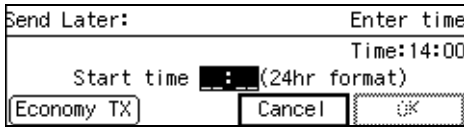

! Limitation

- You cannot specify a User Function key that has already been programmed with another function in this step.

4 Press **[Yes]**.

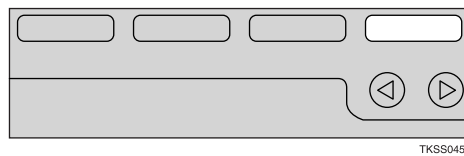
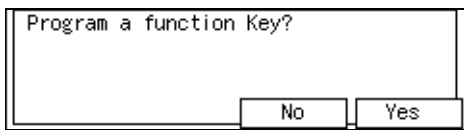

TKSS045N

[F5] is registered and the display showing the operation in progress reappears.

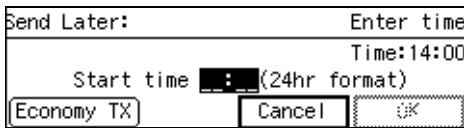

Note

- The operation you have stored is shown as “Custom Functions” on the display.

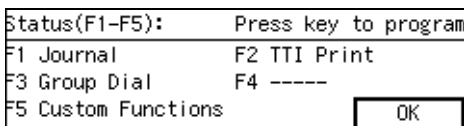

Functions You Can Store in a User Function Key

The following table lists the functions you can store and their default key assignments.

Function Name	Key Assigned to by Default
Journal Print	[F1]
TTI Print	[F2]
Specify Group Number	[F3]
Economy Transmission	—
TONE (UUJ)	—
Batch Transmission ON/OFF	—
Skip Transmission *1	—
Forwarding	—
Duplex Original	—
Subaddress *1	—
Dial Option	—
Line Selection *1	—
Enter Mail Address *1	—
Automatic Mail Reception *1	—
Mail Reception *1	—

*1 Option(s) required

Utilizing User Function Keys

- 1** Press the User Function Key (**[F1]**–**[F5]**) in which the function you want to use is stored.

The stored function's display is shown.

❖ E.g., “Journal Print”

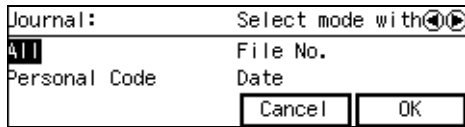

Deleting Functions Stored in User Function Keys

1 Make sure that the machine is in standby mode.

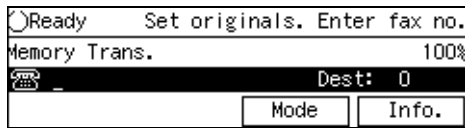

Note

❑ If the “Fax Features” or “Key Op. Tools” screen is shown, press the **[User Tools]** key. If any other display is shown, press the **[Clear Modes/Energy Saver]** key.

2 Press the **[User Tools]** key.

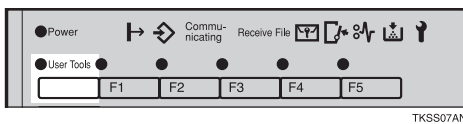

3 Enter the code for “Fax Features” with the number keys.

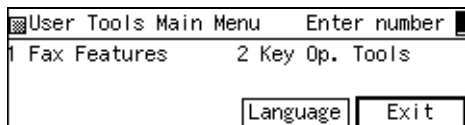

4 Enter the code for “User Functions” with the number keys.

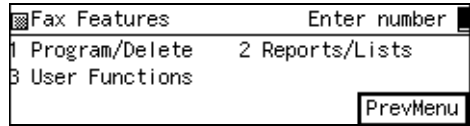

5 Press the User Function key (F1-F5) that you wish to clear.

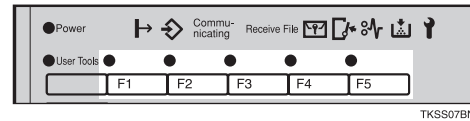
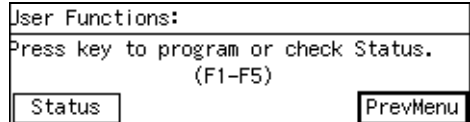

Note

❑ If you make a mistake, press **[Cancel]** and try again.

Checking the currently stored function

1 Press **[Status]**.

2 Press the User Function key you wish to clear.

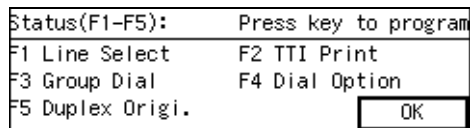

Note

❑ You can also select the User Function key to clear from the status screen.

6 Press the **[Stop]** key to clear the User Function.

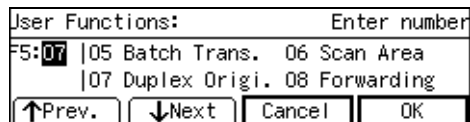

7 Press [OK].

 **Note**

- If you press [Cancel], the function is not deleted and the display in step **5** reappears.
- To clear other User Function keys, press the User Function key (F1-F5) and proceed as before.

8 Press [PrevMenu] twice.

9 Press [Exit] to return to standby mode.

Fax On Demand

This feature requires the optional Fax On Demand kit.

Fax On Demand lets you store documents in memory with a number attached (the box number). When another party wishes to receive the message, they make a transmission request to your machine specifying the box number containing the document they wish to receive.

 **Note**

- When shipped, the Fax On Demand function is turned off by default. Turn it on with the User Parameters.⇒ P.250 “Changing the User Parameters”
- You can also choose whether the requesting party has to specify a password with the User Parameters. The password is the Remote ID.⇒ P.250 “Changing the User Parameters”, ⇒ P.266 “Registering ID Codes”

 **Note**

- For how to edit a box name, see step 8.
- If you wish to edit a document, delete it then register it again.⇒ P.232 “Deleting Fax On Demand Documents”

1 Make sure that the machine is in standby mode.

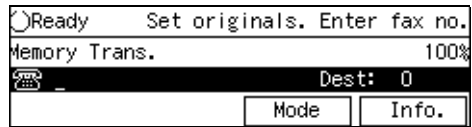

 **Note**

- If the “Fax Features” or “Key Op. Tools” screen is shown, press the [User Tools] key. If any other display is shown, press the [Clear Modes/Energy Saver] key.

2 Press the [User Tools] key.

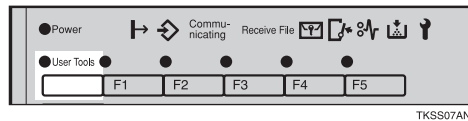

3 Enter the code for “Fax Features” with the number keys.

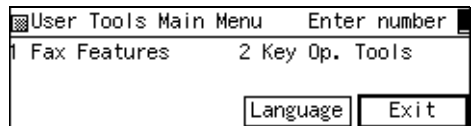

Registering/Editing Fax On Demand Documents

This procedure describes how to store a document in a Fax On Demand and assign it a name.

 **Important**

- After your have registered or edited a document, we recommend that you print the Fax On Demand List to verify the stored contents.⇒ P.235 “Printing the Fax On Demand List”

 **Limitation**

- You can register up to 99 documents with this feature.

- 4** Enter the code for “Fax On Demand” with the number keys.

Fax Features		Enter number
1 Program/Delete	2 Reports/Lists	
3 User Functions	4 Fax On Demand	
		PrevMenu

- 5** Enter the code for “Program FOD” with the number keys.

Fax On Demand 1/2		Enter number
1 Program FOD	2 Delete FOD	
3 Print File	4 Print List	
<input type="button" value="↑Prev."/> <input type="button" value="↓Next"/>		PrevMenu

- 6** Enter the box number to store the document in.

Program FOD:	
Enter number to program or check Status.	
Box(01-99) <input type="text"/>	
<input type="button" value="Status"/>	<input type="button" value="PrevMenu"/>

 **Note**

- If you make a mistake, press [Cancel] and try again.

To Check Currently Registered Documents

- 1** Press [Status].
- 2** Enter the box number to store the document in.

Staus 01-99:		Enter number
01 ----	02 ----	
03 ----	04 ----	
<input type="button" value="↑Prev."/> <input type="button" value="↓Next"/>		<input type="button" value="Cancel"/>

 **Note**

- You can also specify the box number to program from the status screen.
- If a free box number is not displayed, press [↑Prev.] or [↓Next] until one is.
- If you press [Cancel], the display in step 6 reappears.

- 7** Press [Name].

Program FOD:	Enter name
Box 01:	
<input type="text" value="Name"/>	<input type="button" value="Cancel"/> <input type="button" value="OK"/>

<input type="text"/>	<input type="text"/>	<input type="text"/>	<input type="text"/>
			<input type="button" value="←"/> <input type="button" value="→"/>

TKSS042N

- 8** Enter a name for this box, then press [OK].

Enter name	
▶Uppercase	
<input type="text"/>	<input type="button" value="A↔a"/> <input type="button" value="Symbols"/> <input type="button" value="Cancel"/> <input type="button" value="OK"/>

<input type="text"/>	<input type="text"/>	<input type="text"/>	<input type="text"/>
			<input type="button" value="←"/> <input type="button" value="→"/>

TKSS045N

 **Note**

- If this name is already registered, it is displayed. To change the name, press the [Clear] key and enter it again.

 **Reference**

P.319 “Entering and Modifying Text”

- 9** Set your document.

Program FOD:	Set orig., press Start
Box 01:SHOPPING INFORMATION	
<input type="text" value="Name"/>	<input type="button" value="Cancel"/> <input type="button" value="OK"/>

- 10** Press the [Start] key to scan in your document.

When scanning has finished, the document is stored.

- 11** Press [PrevMenu] three times.

- Press [Exit] to return to standby mode.

Deleting Fax On Demand Documents

Follow these steps to delete a document stored in a Fax On Demand.

- Make sure that the machine is in standby mode.

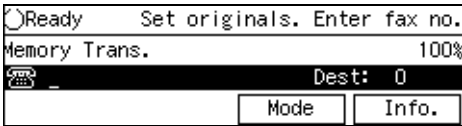

Note

- If the “Fax Features” or “Key Op. Tools” screen is shown, press the [User Tools] key. If any other display is shown, press the [Clear Modes/Energy Saver] key.

- Press the [User Tools] key.

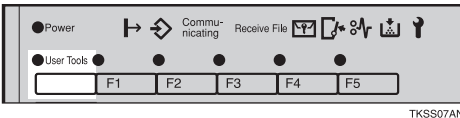

TKSS07AN

- Enter the code for “Fax Features” with the number keys.

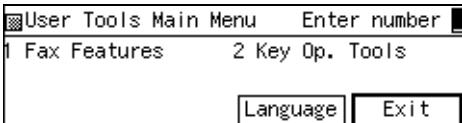

- Enter the code for “Fax On Demand” with the number keys.

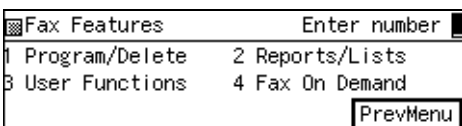

- Enter the code for “Delete FOD” with the number keys.

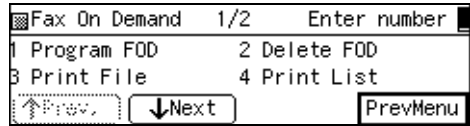

- Enter the number of the box you wish to delete.

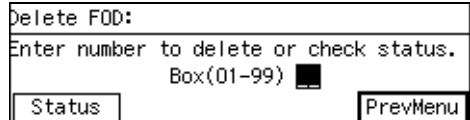

Note

- If you make a mistake, press [Cancel] and try again.

To check currently registered documents

- Press [Status].
- Enter the number of the box to delete.

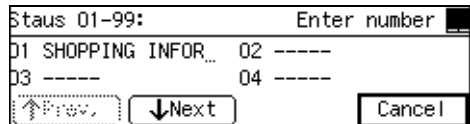

Note

- You can also specify the box number to delete from the status screen.
- If a free box number is not displayed, press [↑Prev.] or [↓Next] until one is.
- If you press [Cancel], the display in step 6 reappears.

If the Box you specified is empty

- 1 The display opposite appears, followed by the display shown in step 6. Enter the box number again.

Not Programmed. Cannot be deleted.

- 7 Choose one of the following procedures.

Deleting just the document

- 1 Press [Document].

Delete FOD:
Box 01:SHOPPING INFORMATION
Cancel Document Label Both

TKSS043N

 **Note**

- If you press [Cancel], the display in step 6 reappears.

- 2 Press [Yes].

Delete document?
No Yes

TKSS043N

 **Note**

- If you press [No], the display in step 6 reappears.

Deleting just the label

- 1 Press [Label].

Delete FOD:
Box 01:SHOPPING INFORMATION
Cancel Document Label Both

TKSS044N

 **Note**

- If you press [Cancel], the display in step 6 reappears.

- 2 Press [Yes].

Delete the name of FOD Box?
No Yes

TKSS045N

 **Note**

- If you press [No], the display in step 6 reappears.

Deleting both document and label

- 1 Press [Both].

Delete FOD:
Box 01:SHOPPING INFORMATION
Cancel Document Label Both

TKSS045N

Note

- ❑ If you press [Cancel], the display in step 6 reappears.

2 Press [Yes].

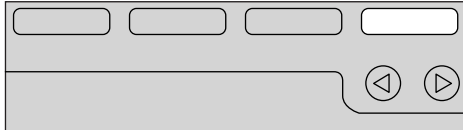
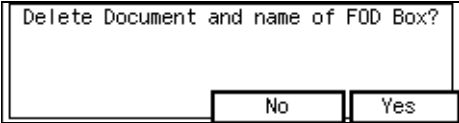

TKSS045N

Note

- ❑ If you press [No], the display in step 6 reappears.

8 Press [PrevMenu] three times.

9 Press [Exit] to return to standby mode.

Printing Fax On Demand Documents

8

Follow these steps to print out a document stored in a Fax On Demand.

1 Make sure that the machine is in standby mode.

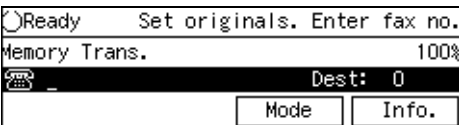

Note

- ❑ If the “Fax Features” or “Key Op. Tools” screen is shown, press the [User Tools] key. If any other display is shown, press the [Clear Modes/Energy Saver] key.

2 Press the [User Tools] key.

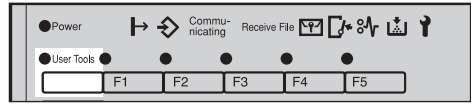

TKSS07AN

3 Enter the code for “Fax Features” with the number keys.

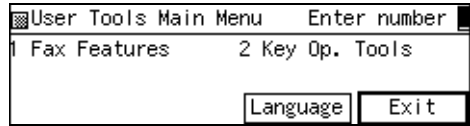

4 Enter the code for “Fax On Demand” with the number keys.

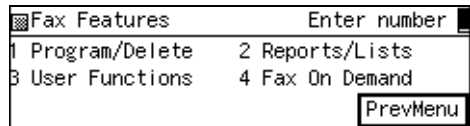

5 Enter the code for “Print File” with the number keys.

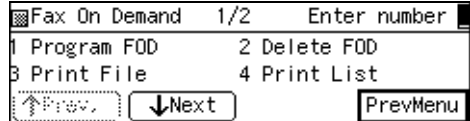

6 Enter the number of the box you wish to print.

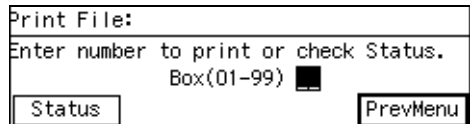

Note

- ❑ If you make a mistake, press [Cancel] and try again.

To Check Currently Registered Documents

1 Press [Status].

- 2 Enter the number of the box to delete.

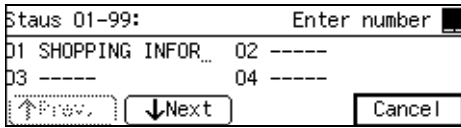

Note

- You can also specify the box number to print from the status screen.
- If a free box number is not displayed, press [↑Prev.] or [↓Next] until one is.
- If you press [Cancel], the display in step 6 reappears.

If the Box you specified is empty

- 1 The display opposite appears, followed by the display shown in step 6. Enter the box number again.

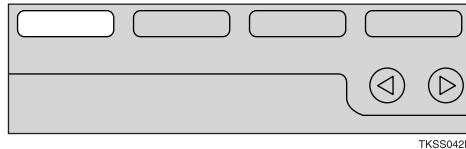
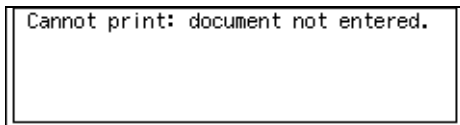

TKSS042N

- 7 Press the [Start] key.

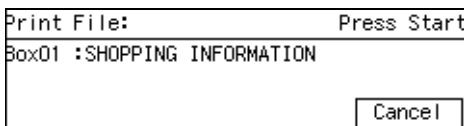

Note

- If you press [Cancel], the display in step 6 reappears.

- 8 Press [PrevMenu] twice.

- 9 Press [Exit] to return to standby mode.

Printing the Fax On Demand List

- 1 Make sure that the machine is in standby mode.

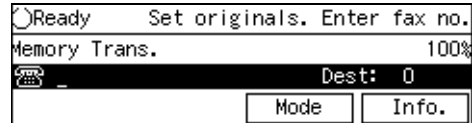

Note

- If the “Fax Features” or “Key Op. Tools” screen is shown, press the [User Tools] key. If any other display is shown, press the [Clear Modes/Energy Saver] key.

- 2 Press the [User Tools] key.

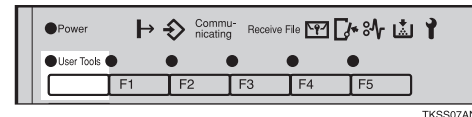

TKSS07AN

- 3 Enter the code for “Fax Features” with the number keys.

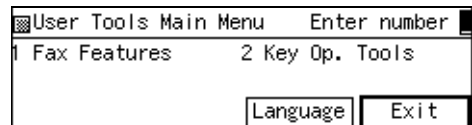

- 4 Enter the code for “Fax On Demand” with the number keys.

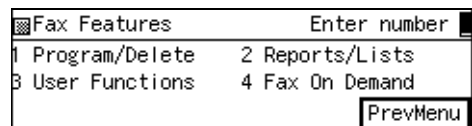

- 5 Enter the code for “Print List” with the number keys.

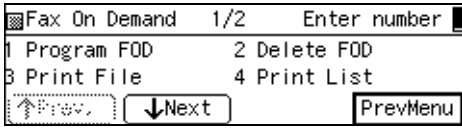

- 6 Press the [Start] key.

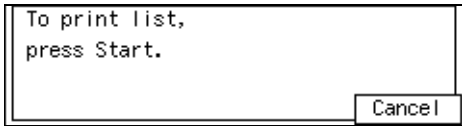

Note

- If you press [Cancel], the display in step 5 reappears.

- 7 Press [PrevMenu] twice.

- 8 Press [Exit] to return to standby mode.

Printing the Fax On Demand Access Report

Print this report to find out how many pages have been sent successfully/ unsuccessfully with the Fax On Demand feature.

- 1 Make sure that the machine is in standby mode.

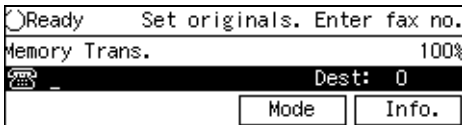

Note

- If the “Fax Features” or “Key Op. Tools” screen is shown, press the [User Tools] key. If any other display is shown, press the [Clear Modes/Energy Saver] key.

- 2 Press the [User Tools] key.

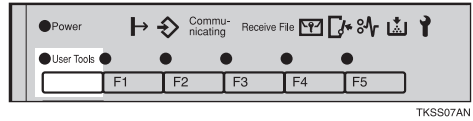

- 3 Enter the code for “Fax Features” with the number keys.

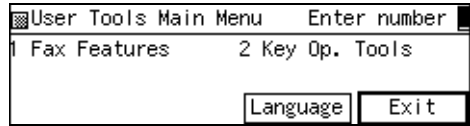

- 4 Enter the code for “Fax On Demand” with the number keys.

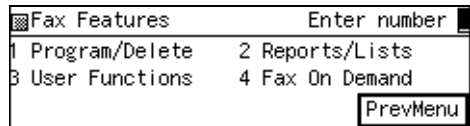

- 5 Enter the code for “Access Report” with the number keys.

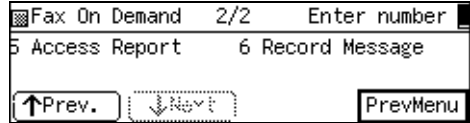

- 6 Press the [Start] key.

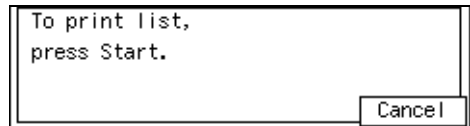

Note

- If you press [Cancel], the display in step 5 reappears.

- 7 Press [PrevMenu] twice.

- 8 Press [Exit] to return to standby mode.

Fax On Demand Recorded Messages

When a caller request a Fax On Demand document, the machine plays back appropriate guidance messages. This section describes how to record these messages.

Note

- You can record the following seven messages, each of which can be up to 30 seconds long:

Message Number	Message Type	Example
1	Greeting message	"This is the XYZ fax information service."
2	Password input guidance	"Please enter the password followed by a # (sharp) character."
3	Box number input guidance 1	"Press # twice to get box one, or enter the box number you need followed by a # character."
4	Box number input guidance 2	"If you require another box, enter the number followed by a # character. To finish press # twice."
5	Transmission guidance	"Please press the Start key to begin transmission."
6	Re-enter guidance	"Please enter again."

Message Number	Message Type	Example
7	Redial guidance	"Please dial again."

- By tailoring messages 3 and 4 you can direct callers to just download the document stored in box 1, or have them choose any of up to five boxes.
- You can also choose whether a password is required with the User Parameters. When turned off, message 2 is skipped.

Recording the Fax On Demand Recorded Messages

Before you begin, plug the microphone into the socket provided on the right side of the machine.

- 1** Make sure that the machine is in standby mode.

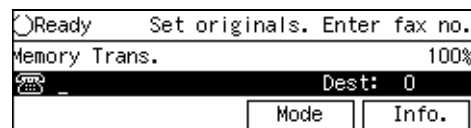

Note

- If the "Fax Features" or "key Op. Tools" screen is shown, press the **[User Tools]** key. If any other display is shown, press the **[Clear Modes/Energy Saver]** key.

- 2** Press the **[User Tools]** key.

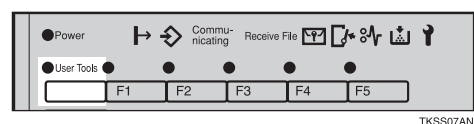

3 Enter the code for “Fax Features” with the number keys.

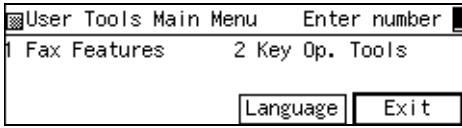

4 Enter the code for “Fax On Demand” with the number keys.

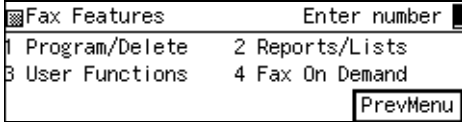

5 Enter the code for “Record Message” with the number keys.

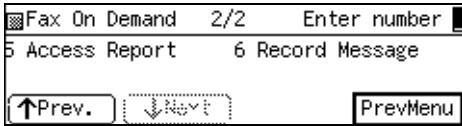

6 Enter the code for “Record Guidance” with the number keys.

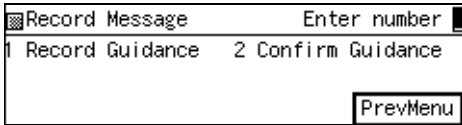

7 Enter the number of the message you wish to record with the number keys.

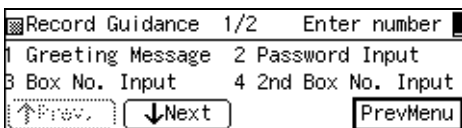

Note
 If the item you require is not displayed, press [**↑Prev.**] or [**↓Next**] until it is.

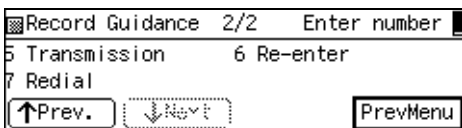

8 Press [**Start**] then speak the message into the microphone.

As you speak, the remaining time available is shown on the display.

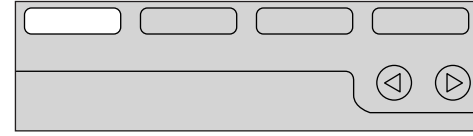
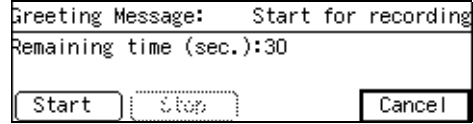

TKSS042N

Note
 If there is still time left when you have finished your message, press [**Stop**].

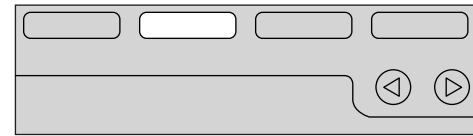
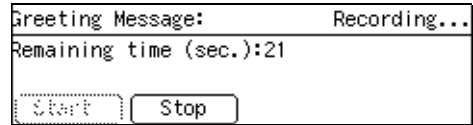

TKSS043N

9 Press [**OK**].

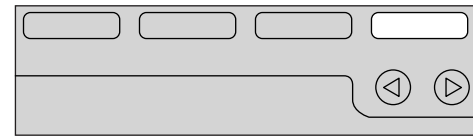

TKSS045N

Note
 Press [**Replay**] to listen to the message you have just recorded.

10 Press [**PrevMenu**] four times.

- 1** Press [Exit] to return to standby mode.

Checking the Fax On Demand Recorded Messages

- 1** Make sure that the machine is in standby mode.

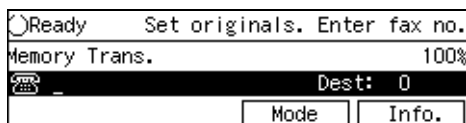

Note

- If the “Fax Features” or “key Op. Tools” screen is shown, press the [User Tools] key. If any other display is shown, press the [Clear Modes/Energy Saver] key.

- 2** Press the [User Tools] key.

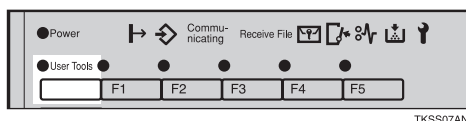

- 3** Enter the code for “Fax Features” with the number keys.

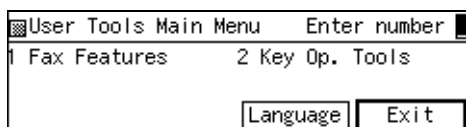

- 4** Enter the code for “Fax On Demand” with the number keys.

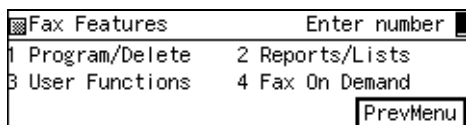

- 5** Enter the code for “Record Message” with the number keys.

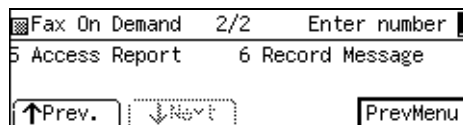

- 6** Enter the code for “Confirm Guidance” with the number keys.

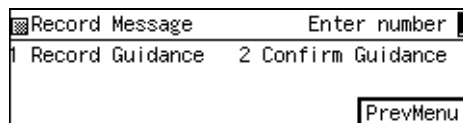

- 7** Enter the number of the message you wish to record with the number keys.

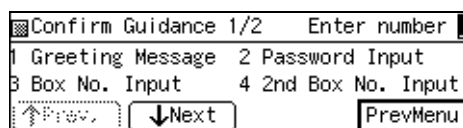

Note

- If the item you require is not displayed, press [↑Prev.] or [↓Next] until it is.

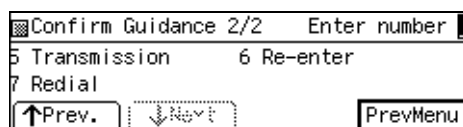

- 8** Listen to the message.



Note

- To stop the message being played, press [Cancel].

- 9** Press [PrevMenu] four times.

- 10** Press [Exit] to return to standby mode.

How callers use Fax On Demand

Note the following:

- If the password option is turned on with the User Parameters, you need to inform the calling party of the password beforehand. The Remote ID is used as the password.
- Callers must wait until messages have completely finished playing before pressing a key.
- Callers can request the contents of up to 5 boxes in one call.

Message 6 (please enter again) is played when:

- The box number has not been entered correctly.
- No key press was detected within 5 seconds after prompting for the box number (message 3).
- The password has not been entered within 5 seconds.

Message 7 (please call again) is played when:

- The wrong password has been entered 3 times in a row.
- An empty box has been selected 3 times in a row.
- Message 3 has been played three times because no key press was detected.
- Message 6 has been played twice because no key press was detected within 5 seconds.

When the password is turned on

1 Dial using On Hook Dial, or lift the handset and dial.

You will hear message 1 then 2.

2 Enter the password with the number keys, then press the **【#】** key.

You will hear message 3.

Now do one of the following:

To choose one or more boxes

1 Enter the box number with the number keys, then press the **【#】** key.

You will hear message 4.

 **Note**

To download another box, enter another box number and press the **【#】** key.

2 Press the **【#】** key twice.

You will hear message 5.

To choose box 1 only

1 Press the **【#】** key twice.

You will hear message 5.

3 Press the **【Start】** key to begin receiving.

When the password is turned off

1 Dial using On Hook Dial, or lift the handset and dial.

You will hear message 1.

Now do one of the following:

To choose one or more boxes

1 Enter the box number with the number keys, then press the **【#】** key.

You will hear message 4.

 **Note**

To download another box, enter another box number and press the **【#】** key.

2 Press the **【#】** key twice.

You will hear message 5.

To choose box 1 only

1 Press the **【#】** key twice.

You will hear message 5.

2 Press the **【Start】** key to begin receiving.

9. Key Operator Tools

Key Operator Tools

These settings allow you to set up functions you frequently use as well as store important information, such as your fax machine's identification. In addition, you can also customize the default settings of each function to suit your requirements. The Key Operator Tools settings are split into the following three categories:

❖ System Settings⇒ P.244

Use to store your own name and fax number, the type of line your machine is connected to, Polling ID and other IDs, Internet Fax Settings (option required) etc.

Also use to adjust the sounds that the machine makes, change the date and time, and check on how many pages the machine as sent or received.

❖ Initial Set Up⇒ P.275

Use to set up Collate, Authorized Reception, Specified Tray, Memory Lock, TX/RX File In HD, Specified Senders, Backup File Transmission, Program Scan Area etc.

❖ Box Settings⇒ P.304

With these settings you can register, edit and delete Personal Boxes, Information Boxes, and Transfer Boxes.

Note

- For the order in which the Key Operator Tools settings are displayed, see P.338 "Function List".
- For detailed information on the above functions, refer to the page reference given.

❖ Navigating Menus

- To access the Key Operator Tools, enter the code for "Kep Op. Tools" from the User Tools main menu, then press the [#] key within 3 seconds.
- Press [↑Prev.] or [Next↓] to switch between screens.
- Press [PrevMenu] to move to the previous menu.
- When you have finished, press [OK]. If you do not press [OK], any changes to the Key Operator Tools settings you have made are not applied.
- Press [Cancel] to cancel the current setting and return to the previous menu.

System Settings

Counters

This function allows you to check the total number of transmitted, received, scanned, and printed pages on the display.

- **Transmissions**
: Total number of transmitted pages
- **Receptions**
: Total number of received pages
- **Scanning**
: The combined total number of pages that have been scanned in when copying and sending faxes.
- **Printing**
: The combined total number of pages that have been printed through fax reception, copying, and PC printing (option).

- 1** Make sure that the machine is in standby mode.

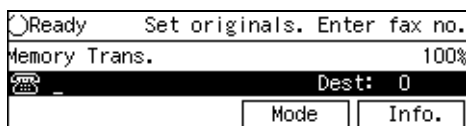

Note

- If the “Fax Features” or “Key Op. Tools” screen is shown, press the **[User Tools]** key. If any other display is shown, press the **[Clear Modes/Energy Saver]** key.

- 2** Press the **[User Tools]** key.

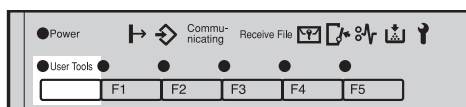

TKSS07AN

- 3** Enter the code for “Key Op. Tools” with the number keys. Then press the **[#]** key.

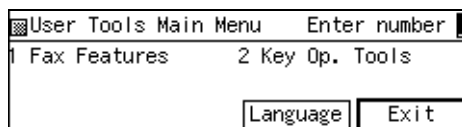

The “Key Op. Tools” main menu appears.

- 4** Enter the code for “System Settings” with the number keys.

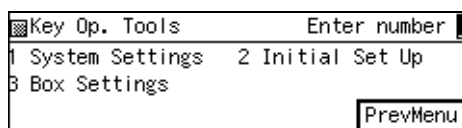

- 5** Enter the code for “Counter” with the number keys.

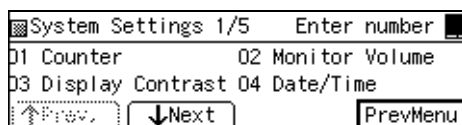

The totals are displayed.

- 6** When you have checked the total pages, press **[OK]**.

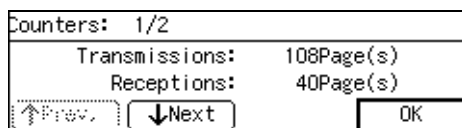

Note

- Press **[↑Prev.]** or **[↓Next]** to switch between page 1 and 2. Page 1 shows the total number of pages sent and received, page 2 shows the total number of pages scanned and printed.

- 7** Press **[PrevMenu]** twice.

- 8** Press [Exit] to return to standby mode.

Monitor Volume

You can change the volume of the following sounds the machine makes:

- ❖ **On Hook**
Sounds made when the [On Hook Dial] key has been pressed.
 - ❖ **Transmission**
Sounds made when the machine is sending a message.
 - ❖ **Reception**
Sounds made when the machine is receiving a message.
 - ❖ **Dialling**
Sounds made after pressing the [Start] key while establishing a connection with the other party.
 - ❖ **Scroll Key**
Sound made when an operation panel key is pressed.
 - ❖ **Alarm**
Sound made when a cover is opened etc.
- 1** Make sure that the machine is in standby mode.

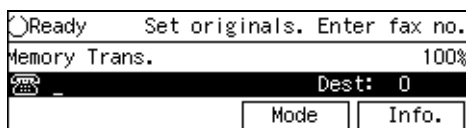

Note

- If the “Fax Features” or “Key Op. Tools” screen is shown, press the [User Tools] key. If any other display is shown, press the [Clear Modes/Energy Saver] key.

- 2** Press the [User Tools] key.

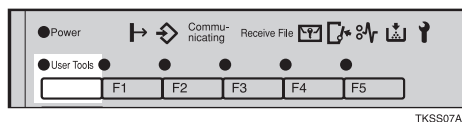

- 3** Enter the code for “Key Op. Tools” with the number keys. Then press the [#] key.

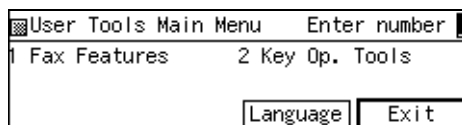

The “Key Op. Tools” main menu appears.

- 4** Enter the code for “System Settings” with the number keys.

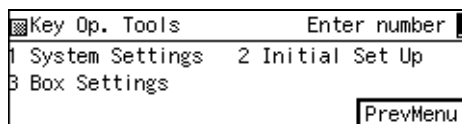

- 5** Enter the code for “Monitor Volume” with the number keys.

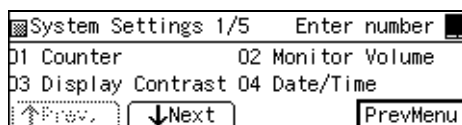

- 6** Select an item you want to adjust pressing [↑Prev.] and [↓Next].

Note

- On Hook, Transmission, Reception, Dialling, Scroll Key, and Alarm are shown in that order.

◆ On Hook

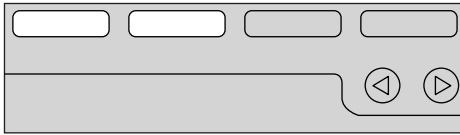
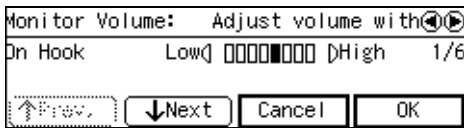

TKSS048N

- 7** Adjust the volume using the ◀ or ▶ keys and press [OK].

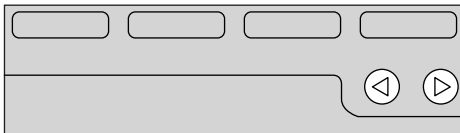
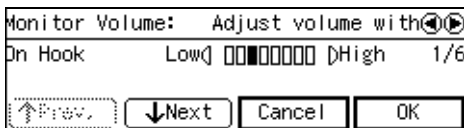

TKSS048N

◆ Note

- When you press [Cancel], the volume setting is canceled and the display shown in **5** appears again.
- Lowest = OFF

- 8** Press [PrevMenu] twice.

- 9** Press [Exit] to return to the standby mode.

Adjusting the Display Contrast

Follow these steps to adjust the contrast of the operation panel display. Eight levels of contrast are available.

- 1** Make sure that the machine is in standby mode.

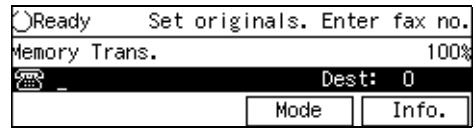

◆ Note

- If the “Fax Features” or “Key Op. Tools” screen is shown, press the [User Tools] key. If any other display is shown, press the [Clear Modes/Energy Saver] key.

- 2** Press the [User Tools] key.

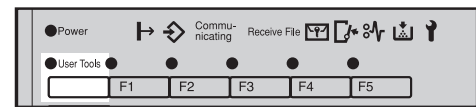

TKSS07AN

- 3** Enter the code for “Key Op. Tools” with the number keys. Then press the [#] key.

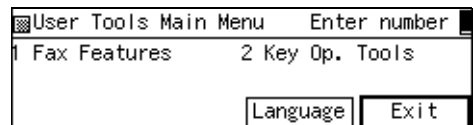

- 4** Enter the code for “System Settings” with the number keys.

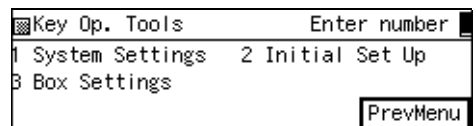

- 5** Enter the code for “Display Contrast” with the number keys.

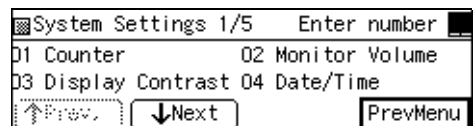

Note

- If the item you require is not displayed, press [**↑Prev.**] or [**↓Next**] until it is.

- Press the **◀** or **▶** keys to adjust the contrast.

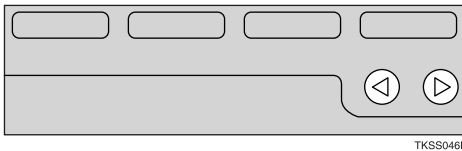

TKSS046N

- Press [**OK**].

Note

- If you press [**Cancel**], the display in step 6 reappears.

- Press [**PrevMenu**] twice.

- Press [**Exit**] to return to the standby mode.

Date/Time

Use this function to set your machine's internal clock to the current time and date.

Reference

P.33 "Date/Time"

Summer Time/DST

Whenever local custom requires advancing the clock or setting the clock back, use this feature.

Reference

P.34 "Summer Time/DST"

Registering the Economy Transmission Time

Economy Transmission allow you to take advantage of off-peak line rates by delaying transmission of messages until a later time.

Use the procedure below to program the Economy Transmission Time for when your phone rates are cheaper. ⇒ P.118 "Send Later"

Limitation

- You can program only one Economy Transmission time.

- Make sure that the machine is in standby mode.

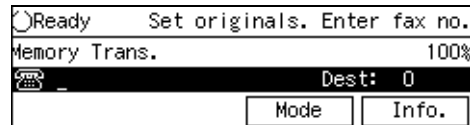
**Note**

- If the "Fax Features" or "Key Op. Tools" screen is shown, press the [**User Tools**] key. If any other display is shown, press the [**Clear Modes/Energy Saver**] key.

- Press the [**User Tools**] key.

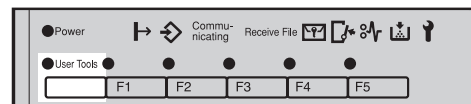

TKSS07AN

- Enter the code for "Key Op. Tools" with the number keys. Then press the [**#**] key.

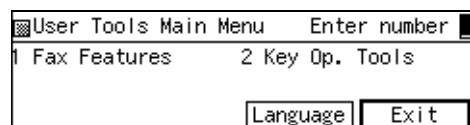

The "Key Op. Tools" main menu appears.

4 Enter the code for “System Settings” with the number keys.

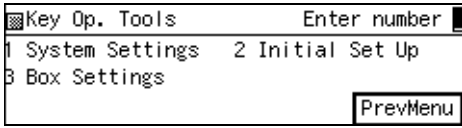

5 Enter the code for “Economy TX” with the number keys.

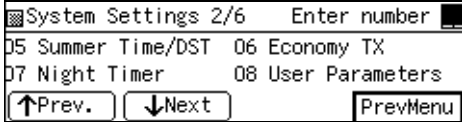

6 Enter the economy transmission time with the number keys. When the setting is correct, press [OK].

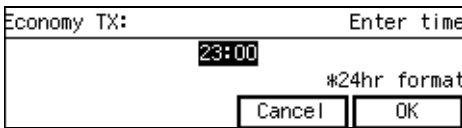

Note

- If you press [Cancel], the entered time is canceled and the display shown in **5** appears again.

7 Press [PrevMenu] twice.

8 Press [Exit] to return to the standby mode.

Night Timer

Use this feature to have the machine turn its heater on and off automatically at the times that you prescribe. For example, by having the heater turned off during the evening, on holidays or at other times when you are absent, you can cut on power costs.

Note

- You can program the timer to turn on or off twice daily over a 1-week cycle.
- Incoming faxes are received to memory (Substitute Reception) when the heater is off and not printed until the heater comes back on.
- To edit settings already stored for this feature, follow the same procedure for storing settings (the following procedure).

1 Make sure that the machine is in standby mode.

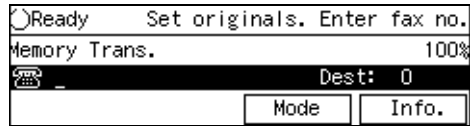

Note

- If the “Fax Features” or “Key Op. Tools” screen is shown, press the [User Tools] key. If any other display is shown, press the [Clear Modes/Energy Saver] key.

2 Press the [User Tools] key.

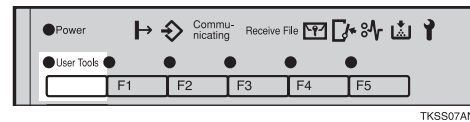

3 Enter the code for “Key Op. Tools” with the number keys. Then press the [#] key.

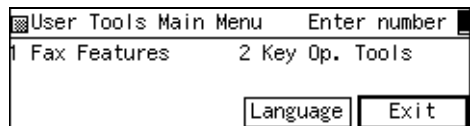

The “Key Op. Tools” menu appears.

- 4** Enter the code for “System Settings” with the number keys.

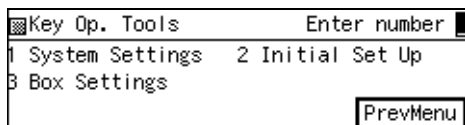

- 5** Enter the code for “Night Timer” with the number keys.

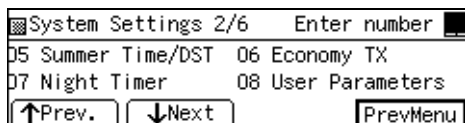

Note

- If the item you require is not displayed, press [↑Prev.] or [↓Next] until it is.

- 6** Press the ◀ or ▶ keys to turn the timer on or off.

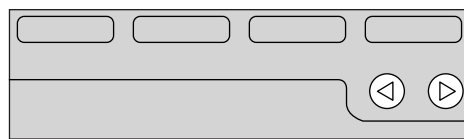
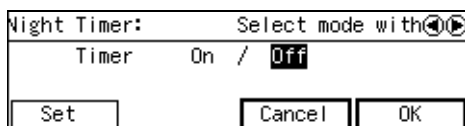

To turn the timer Off

- 1** Press the arrow keys to select “Off”.
- 2** Press [OK].
- 3** Press [PrevMenu] twice, then press [Exit].

- 7** Press [Set].

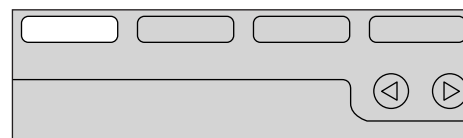
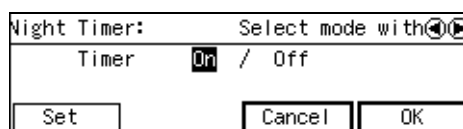

- 8** Press [↓Next] to scroll through the days of the week and timers (1 or 2).

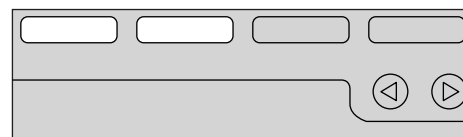
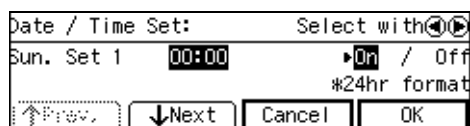

- 9** Press the [Stop] key to clear the current timer setting.

- 10** Enter the time in 24-hour format on the number keys.

Note

- If you make a mistake, press the [Clear] key and enter it again.

- 11** Press the ◀ or ▶ keys to select whether to turn the heater on or off at this time.

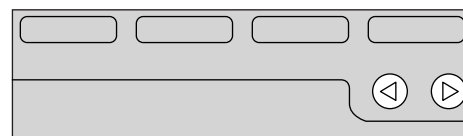
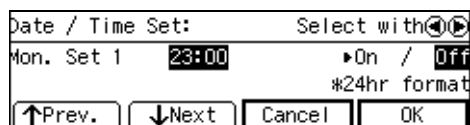

Note

- ❑ If you are programming both timers for this day, then press [↓Next] to display the other timer (e.g. “Set 2”) and repeat this procedure.
- ❑ To set a timer for another day, press [↓Next] to display the timer and adjust it as necessary.

12 Press [OK].

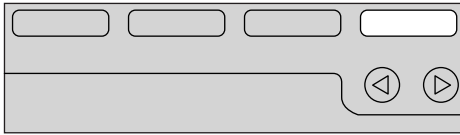
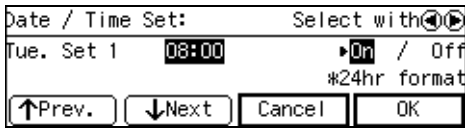

TKSS045N

13 Press [OK].

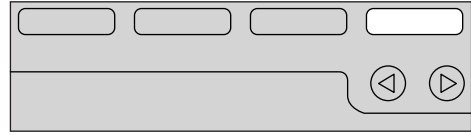
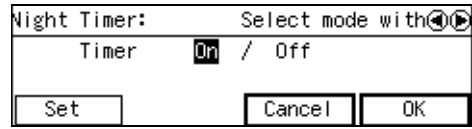

TKSS045N

14 Press [PrevMenu] twice.

15 Press [Exit] to return to standby mode.

Changing the User Parameters

The User Parameters allow you to customize various settings to match your needs.

Preparation

Access to some User Parameter Settings requires installation of optional equipment or that other settings be made beforehand.

Switches and Bits

User Parameters are divided into switches, and each switch is divided into eight bits. The right most bit is bit 0 and the left most is bit 7.

Switch 00	0	1	0	0	0	0	0	0
	↓	↓	↓	↓	↓	↓	↓	↓
	7	6	5	4	3	2	1	0

❖ User Parameter List

Switch	Bit	Item	0	1
00	0	Stamp home position	Off	On
	3,2,1	Image density adjustment level home position 000: Normal, 001: Lighten, 010: Darken		
	5,4	Resolution home position 00: Standard, 01: Detail, 10: Fine		
	6	Transmission Mode home position	Memory Transmission	Immediate Transmission
	7	Halftone home position	Off	On
01	7	Return the machine to the home settings after each communication	Off	On
02	0	Forwarding Mark	Off	On
	1	Center Mark	Off	On
	2	Print RX Time	Off	On
	3	TSI Print	Off	On
	4	Checkered Mark	Off	On
	5	CIL Print (optional G4 Unit required)	Off	On
	6	TID Print (optional G4 Unit required)	Off	On

Switch	Bit	Item	0	1
03	0	Print Communication Result Report (Memory Transmission) automatically	Off	On
	2	Print File Reserve Report (Memory Transmission) automatically	Off	On
	3	Print File Reserve Report (Polling Reception) automatically	Off	On
	4	Print Communication Result Report (Polling Reception)	Off	On
	5	Print Transmission Result Report automatically	Off	On
	6	Print Polling Transmission Clear Report automatically	Off	On
	7	Print Journal automatically	Off	On
04	0	Print Confidential File Report automatically	Off	On
	1	Print Fax On Demand Report automatically (optional Fax On Demand required)	Off	On
	7	Print portion of image on some reports	Off	On
05	0	Substitute Reception	Off	On
	1	Memory Reception if no RTI or CSI received	Possible	Not possible
	3	High Temperature Standby mode	Off	On
	5,4	Restricted Access 00: Off, 01: On, 10: On when the Night Timer is on		
	7,6	Energy Saver Mode 00: Low Power Standby mode, 01: Fax Standby mode, 11: Do not change to Energy Saver Mode		

Switch	Bit	Item	0	1
06	0	Print the TTI or CIL (optional G4 Unit required) on messages at the other end	Off	On
	2	ID Transmission	Off	On
	4	Batch Transmission	Off	On
	5	Skip Transmission home setting (optional Function Upgrade Card required)	Off	On
	7	Backup File Transmission	Off	On
07	2	Parallel Memory Transmission	Off	On
	3	Auto Reduction	Off	On
	7,6	Fax On Demand (optional Fax On Demand required) 00: Off 01: The other party is not required to enter the password to access the Fax On Demand service 10: The other party is required to enter the password to access the Fax On Demand service		

Switch	Bit	Item	0	1
08	1,0	Collate 00: Off 01: Messages from senders whose RTI/CSI/G4 TIDs are programmed are collated 11: Messages from senders whose RTI/CSI/G4 TIDs are not programmed are collated		
	3,2	Authorized Reception 00: Off 01: Receive messages only from senders whose RTI/CSI/G4 TIDs are programmed 11: Receive messages only from senders whose RTI/CSI/G4 TIDs are not programmed		
	5,4	Specified Tray Selection (optional Paper Supply Unit required) 00: Off 01: Messages from senders whose RTI/CSI/G4 TIDs are programmed are printed from the main paper tray 11: Messages from senders whose RTI/CSI/G4 TIDs are not programmed are printed from the main paper tray		
	7,6	Forwarding 00: Off 01: Forward Messages only from senders whose RTI/CSI/G4 TIDs are programmed 11: Forward Messages only from senders whose RTI/CSI/G4 TIDs are not programmed		

Switch	Bit	Item	0	1
09	1,0	Memory Lock 00: Off 01: Messages from senders whose RTI/CSI/G4 TIDs are programmed are not printed unless you enter the Memory Lock ID 11: Messages from senders whose RTI/CSI/G4 TIDs are not programmed are not printed unless you enter the Memory Lock ID		
	3,2	TX/RX File In HD (optional 40M Expanded Memory Card and optional Function Upgrade Card are required) 00: Off 01: Messages from senders whose RTI/CSI/G4 TIDs are programmed are stored in the memory disk 11: Messages from senders whose RTI/CSI/G4 TIDs are not programmed are stored on the memory disk		
10	1	Two in One	Off	On
	2	Image Rotation	Off	On
	3	Page Reduction	Off	On
	4	Rotate Sort	Off	On
	7	Halftone mode	Standard Mode	Speed Mode
11	0	Transfer Request By Tonal Signals	Off	On
	1	Selection of tone (PB) or UUI after tone (-) (when the optional G4 Unit is installed)	UUI	PB
	5	Whether "To" prefixes the label when Label Insertion is turned on.	No	Yes
	6	Print Forwarded Messages Locally	Off	On
	7	Polling Files After Transmission	Delete	Standby

Switch	Bit	Item	0	1
12	2	Toner Saving Mode	Off	On
	4,3	Print Image Density 00: Normal, 01: Lighten, 10: Darken		
	7	Copying	Possible	Not Possible
13	1,0	Use the main G3 line as an internal extension, or an outside line. 00:Outside Line, 01:Extension (PREFIX), 10:Extension (GND), 11:Extension (FLASH)		
	3,2	Use the extended G3 line as an internal extension, or an outside line. 00:Outside Line, 01:Extension (PREFIX), 10:Extension (GND), 11:Extension (FLASH)		

How to set the User Parameters

This example shows how to change the default transmission mode when the machine is shipped from Memory Transmission to Immediate Transmission. To do this, we must change switch 00 bit 6 from 0 to 1.

Important

- We recommend that you print the User Parameter list and keep it when you register or change a user parameter. => P.257 "Printing the User Parameter List"
- Do not change any bit switches other than those shown on the previous pages.

1 Make sure that the machine is in standby mode.

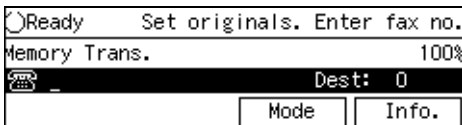

Note

- If the "Fax Features" or "Key Op. Tools" screen is shown, press the [User Tools] key. If any other display is shown, press the [Clear Modes/Energy Saver] key.

2 Press the [User Tools] key.

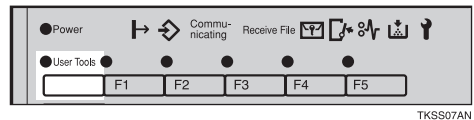

3 Enter the code for "Key Op. Tools" with the number keys. Then press the [#] key.

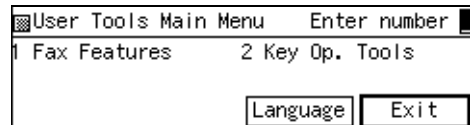

The "Fax Features" menu appears.

4 Enter the code for "System Settings" with the number keys.

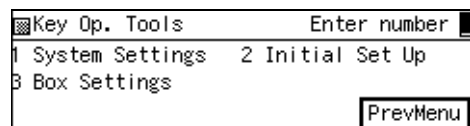

- 5** Enter the code for “User Parameters” with the number keys.

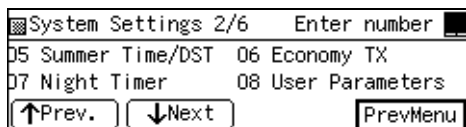

- 6** Make sure that switch 00 is displayed.

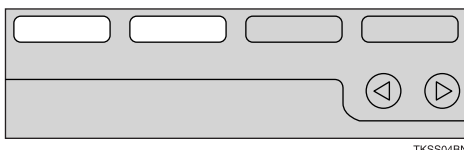
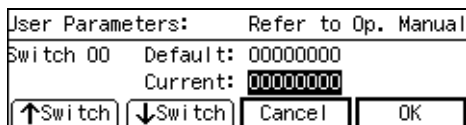

Note

- To show other switches, press [↑Switch] or [↓Switch].

- 7** Press number key [6] to change bit 6 to 1.

Note

- Each time you press number key 6, the value will switch between 1 and 0.
- The bits are displayed in ascending order from right to left, the right most bit being bit 0.
- You can adjust several bits at the same time from this screen.

- 8** Press [OK].

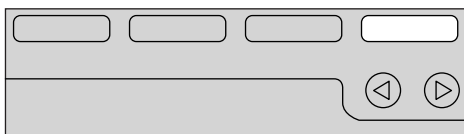
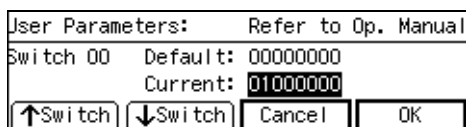

Note

- If you press [cancel], the display in step 5 reappears.

- 9** Press [PrevMenu] twice.

- 10** Press [Exit] to return to the standby display.

Printing the User Parameter List

Print this list to see the current User Parameter settings.

- 1** Make sure that the machine is in standby mode.

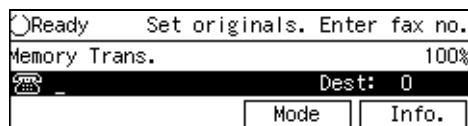

Note

- If the “Fax Features” or “Key Op. Tools” screen is shown, press the [User Tools] key. If any other display is shown, press the [Clear Modes/Energy Saver] key.

- 2** Press the [User Tools] key.

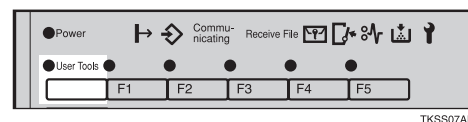

- 3** Enter the code for “Key Op. Tools” with the number keys. Then press the [#] key.

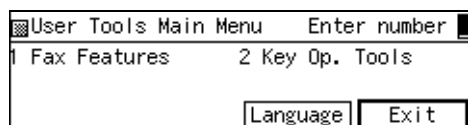

The “Fax Features” menu appears.

4 Enter the code for “System Settings” with the number keys.

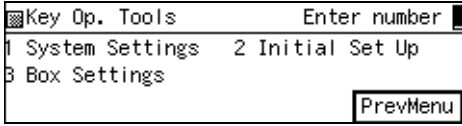

5 Enter the code for “Prt. User Param.” with the number keys.

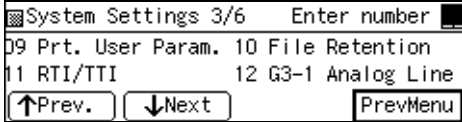

6 Press the [Start] key to print the list.

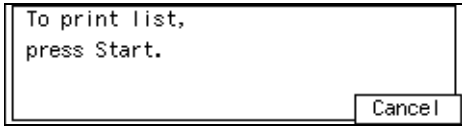

Note

❑ If you press [Cancel] before printing starts, the printing stops and the display shown in **5** appears again.

7 Press [PrevMenu] twice.

8 Press [Exit] to return to the standby display.

File Retention

If a connection could not be made to the other party during a Memory Transmission even though the number was redialed the stipulated number of times, this setting specifies whether or not the file/document is preserved in memory.

If a file/document is stored in memory, you can easily resent it without having to scan it in again.

1 Make sure that the machine is in standby mode.

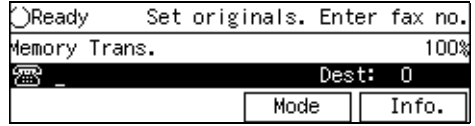

Note

❑ If the “Fax Features” or “Key Op. Tools” screen is shown, press the [User Tools] key. If any other display is shown, press the [Clear Modes/Energy Saver] key.

2 Press the [User Tools] key.

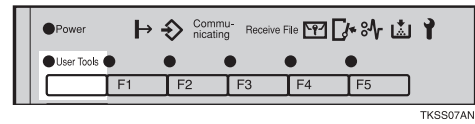

3 Enter the code for “Key Op. Tools” with the number keys. Then press the [#] key.

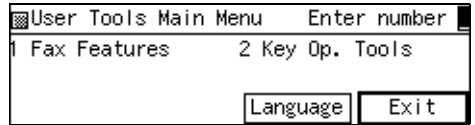

4 Enter the code for “System Settings” with the number keys.

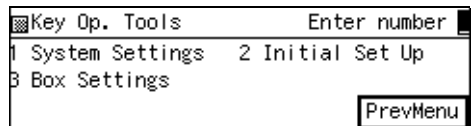

5 Enter the code for “File Retention” with the number keys.

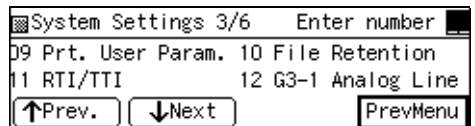

Note

- ❑ If the item you require is not displayed, press [**↑Prev.**] or [**↓Next**] until it is.

- 6 Press the **◀** or **▶** keys to select the time or turn this feature off.

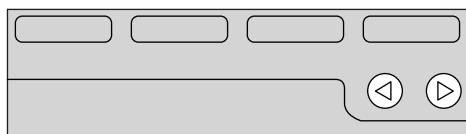
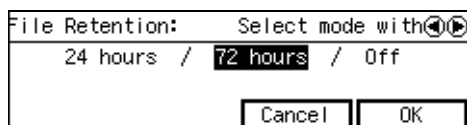

TKSS046N

- 7 Press [**OK**].
- 8 Press [**PrevMenu**] twice.
- 9 Press [**Exit**] to return to standby mode.

RTI/TTI

The RTI (Receive Terminal Identification) is used to identify your machine to the other party when communicating with machines of the same make. The TTI (Transmitter Terminal Identification) is printed on the header of every fax you send and aids the other party identify your fax messages.

Reference

P.35 "Registering your RTI and TTI"

G3-1 Analog Line

You need to register the following items before you connect the machine to a G3 analog line:

- **PSTN Line Type**
Select whether the connected line uses tone or pulse dialing.

- **CSI (up to 20 digits)**
The CSI (Called Station Identification) is passed to the other party when you send or receive a fax. When the CSI is received, it is shown on the display or printed on reports on the receiver's or sender's machine. The CSI works even if the receiver or sender uses a different make machine. The CSI can be up to 20 characters long and contain a plus sign (+), numbers and spaces. Register your country code, area code (minus the leading zero) and your fax number in that order.
- **PSTN Access Number**
Use this setting to save having to enter a pause after the PSTN Access Number when dialing. For example, if you register "0" as the PSTN Access Number, a pause will be inserted automatically after the "0" when dialing.

Note

- ❑ The CSI feature is not available in some countries.
- ❑ When using sending to Transfer Stations or machines set up with Transfer Boxes, you need to register the CSI with your own analog number (the telephone number to which your machine is connected) so that the transfer station can return the Transfer Result report to you. Be sure to enter a pause after the area code.

- 1 Make sure that the machine is in standby mode.

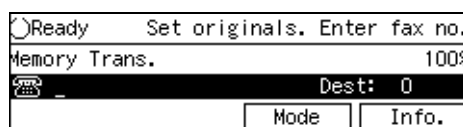

Note

- ❑ If the “Fax Features” or “Key Op. Tools” screen is shown, press the **[User Tools]** key. If any other display is shown, press the **[Clear Modes/Energy Saver]** key.

2 Press the **[User Tools]** key.

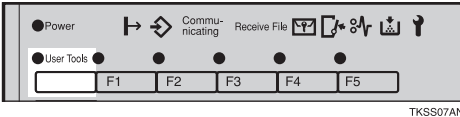

3 Enter the code for “Key Op. Tools” with the number keys. Then press the **[#]** key.

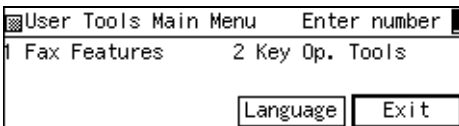

The “Fax Features” menu appears.

4 Enter the code for “System Settings” with the number keys.

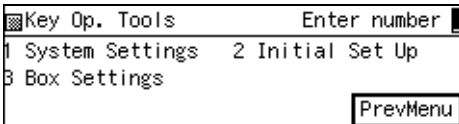

5 Enter the code for “G3-1 Analog Line” with the number keys.

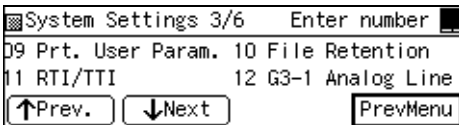

6 Enter the code for “PSTN Line Type” with the number keys.

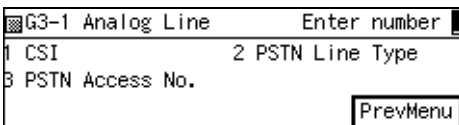

7 Select your line type with the arrow keys then press **[OK]**.

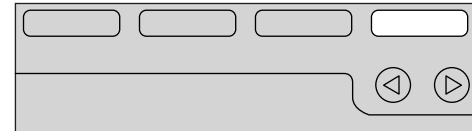
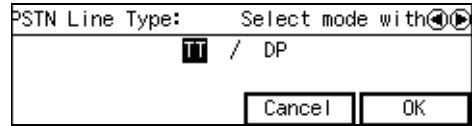

8 Enter the code for “CSI” with the number keys.

9 Enter your CSI then press **[OK]**.

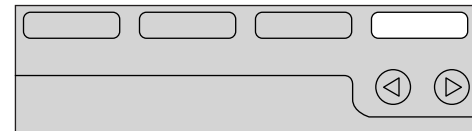
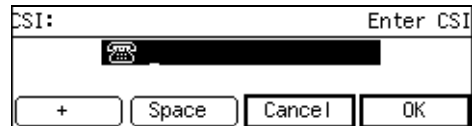

Registering a PSTN Access Number

1 Enter the code for “PSTN Access No.” with the number keys.

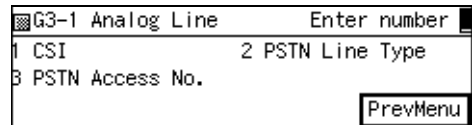

2 Enter PSTN Access Number with the number key, then press **[OK]**.

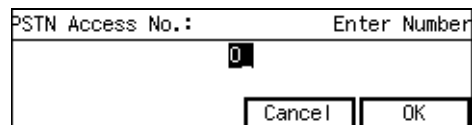

10 Press **[PrevMenu]** three times.

- 1 Press [Exit] to return to the standby mode.

G3-2 Analog Line

This function requires the optional G3 Unit.

You need to register the following items before you connect the machine to a second G3 analog line:

- **PSTN Line Type**
Select whether the connected line uses tone or pulse dialing.
- **CSI (up to 20 digits)**
The CSI (Called Station Identification) is passed to the other party when you send or receive a fax. When the CSI is received, it is shown on the display or printed on reports on the receiver's or sender's machine. The CSI works even if the receiver or sender uses a different make machine. The CSI can be up to 20 characters long and contain a plus sign (+), numbers and spaces. Register your country code, area code (minus the leading zero) and your fax number in that order.
- **PSTN Access Number**
Use this setting to save having to enter a pause after the PSTN Access Number when dialing. For example, if you register "0" as the PSTN Access Number, a pause will be inserted automatically after the "0" when dialing.

Note

- The CSI feature is not available in some countries.

- When using sending to Transfer Stations or machines set up with Transfer Boxes, you need to register the CSI with your own analog number (the telephone number to which your machine is connected) so that the transfer station can return the Transfer Result report to you. Be sure to enter a pause after the area code.

- 1 Make sure that the machine is in standby mode.

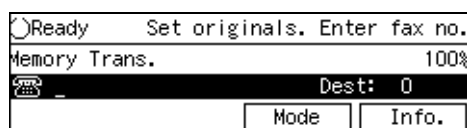

Note

- If the "Fax Features" or "Key Op. Tools" screen is shown, press the [User Tools] key. If any other display is shown, press the [Clear Modes/Energy Saver] key.

- 2 Press the [User Tools] key.

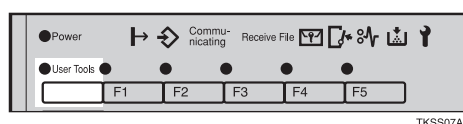

- 3 Enter the code for "Key Op. Tools" with the number keys. Then press the [#] key.

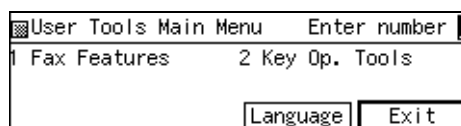

The "Key Op. Tools" menu appears.

4 Enter the code for “System Settings” with the number keys.

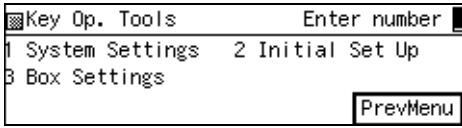

5 Enter the code for “G3-2 Analog Line” using the number keys.

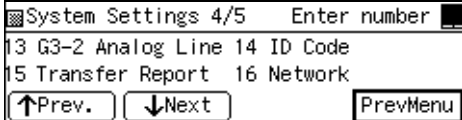

6 Enter the code for “PSTN Line Type” using the number keys.

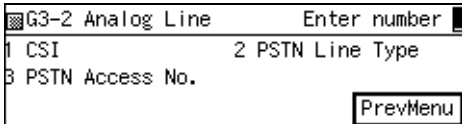

7 Select the desired line type and press [OK].

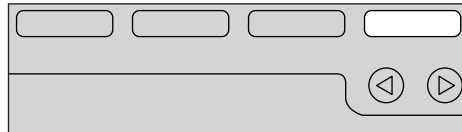
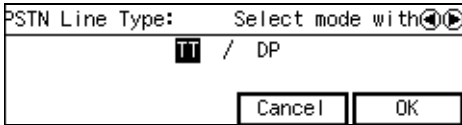

TKSS045N

8 Enter the code for “CSI” with the number keys.

9 Enter your CSI and press [OK].

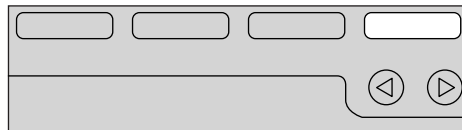
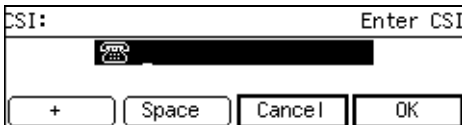

TKSS045N

Registering a PSTN Access Number

1 Enter the code for “PSTN Access No.” with the number keys.

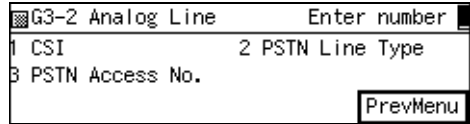

2 Enter PSTN Access Number with the number key, then press [OK].

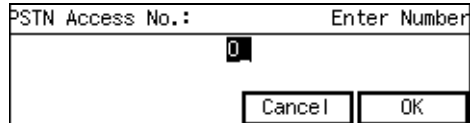

10 Press [PrevMenu] three times.

11 Press [Exit] to return to the stand-by mode.

G3 Digital Line

This function requires the optional G4 Unit.

The following settings are available for G3 communications over ISDN:

- Own Fax Number 1
Enter the number of the line the machine is connected to.
- Own Fax Number 2
If using a single line with 2 numbers, enter the second fax number.
- Sub-address
- CSI (maximum 20 characters)
Enter the international identification number that is transferred to the other party during transmission or reception.

Note

- Before storing the sub-address, store the sub-address function in a User Function key.⇒ P.225 “Assigning User Function Keys”
- The CSI is an international identification number that is transferred to the other party during transmission or reception. This information appears on the display of the other party's fax machine and is printed on their lists and reports. The CSI feature works with other manufacturer's fax machines that support this feature.
- The CSI can obtain digits 0-9, “+” and spaces.

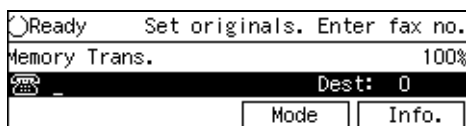
1 Make sure that the machine is in standby mode.**Note**

- If the “Fax Features” or “Key Op. Tools” screen is shown, press the **[User Tools]** key. If any other display is shown, press the **[Clear Modes/Energy Saver]** key.

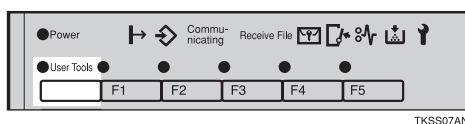
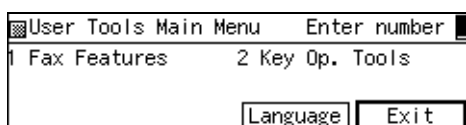
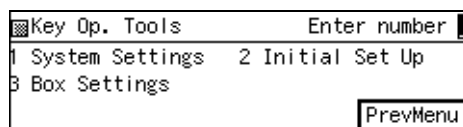
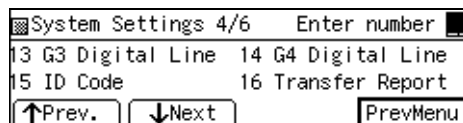
2 Press the **[User Tools]** key.**3** Enter the code for “Key Op. Tools” with the number keys. Then press the **[#]** key.**4** Enter the code for “System Settings” with the number keys.**5** Enter the code for “G3 Digital Line” with the number keys.**Note**

- If the item you require is not displayed, press **[↑Prev.]** or **[↓Next]** until it is.

Registering your Own Fax Number 1

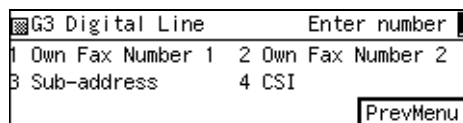
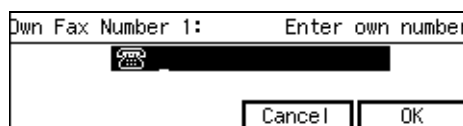
1 Enter the code for “Own Fax Number 1” with the number keys.**2** Enter the fax number.**3** Press **[OK]**.

Registering your Own Fax Number 2

1 Enter the code for "Own Fax Number 2" with the number keys.

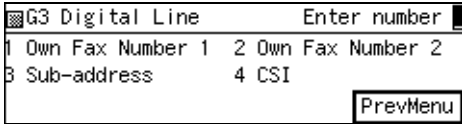

2 Enter the fax number.

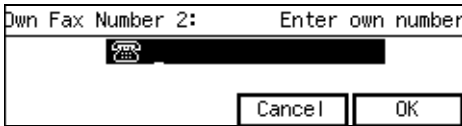

3 Press [OK].

Registering the Sub-address

1 Enter the code for "Sub-address" with the number keys.

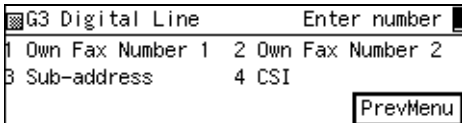

2 Enter the sub-address.

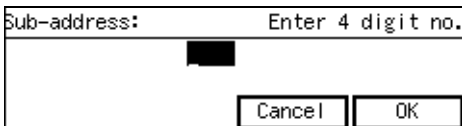

3 Press [OK].

Registering the CSI

1 Enter the code for "CSI" with the number keys.

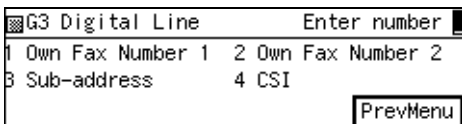

2 Enter the CSI.

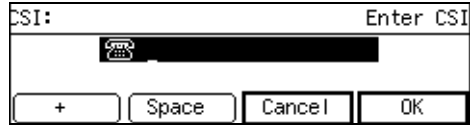

3 Press [OK].

6 Press [PrevMenu] three times.

7 Press [Exit] to return to standby mode.

G4 Digital Line

This function requires the optional G4 unit.

Register these settings before connecting to the ISDN. You can store the following items:

- Own Fax Number 1
Enter the fax number of the PSTN the machine is connected to.
- Own Fax Number 2
If using a single line with 2 numbers, enter the second fax number.
- Sub-address
- TID (maximum 22 characters)

1 Make sure that the machine is in standby mode.

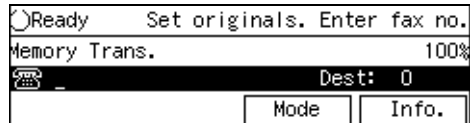

Note

- If the "Fax Features" or "Key Op. Tools" screen is shown, press the [User Tools] key. If any other display is shown, press the [Clear Modes/Energy Saver] key.

- 2** Press the **[User Tools]** key.

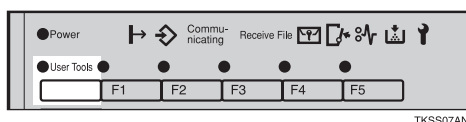

TKSS07AN

- 3** Enter the code for “Key Op. Tools” with the number keys. Then press the **[#]** key.

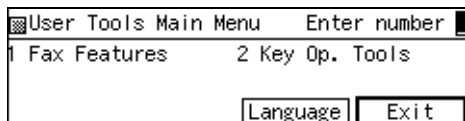

- 4** Enter the code for “System Settings” with the number keys.

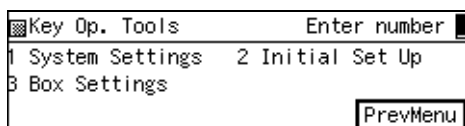

- 5** Enter the code for “G4 Digital Line” with the number keys.

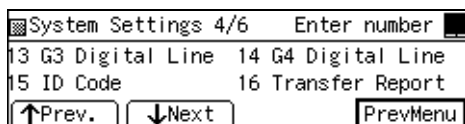

Note

- If the item you require is not displayed, press **[↑Prev.]** or **[↓Next]** until it is.

Registering your Own Fax Number 1

- 1** Enter the code for “Own Fax Number 1” with the number keys.

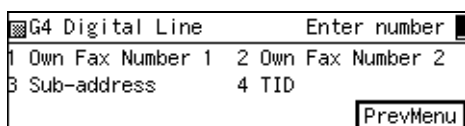

- 2** Enter the fax number.

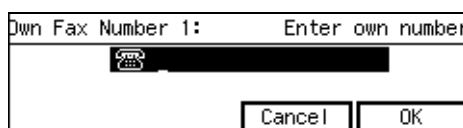

- 3** Press **[OK]**.

Registering your Own Fax Number 2

- 1** Enter the code for “Own Fax Number 2” with the number keys.

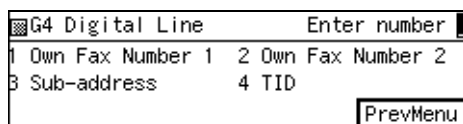

- 2** Enter the fax number.

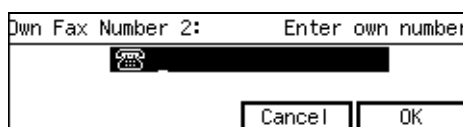

- 3** Press **[OK]**.

Registering the Sub-address

- 1** Enter the code for “Sub-address” with the number keys.

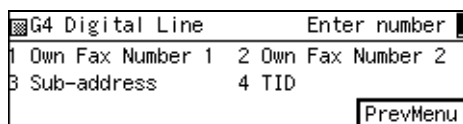

- 2** Enter the sub-address.

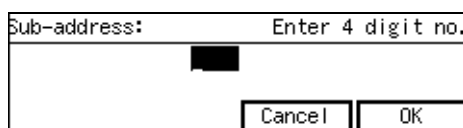

- 3** Press **[OK]**.

Registering the TID

- 1 Enter the code for "TID" with the number keys.

- 2 Enter the code for "Country Code" with the number keys.

- 3 Enter your country code with the number keys.

- 4 Press [OK].
- 5 Enter the code for "Own Digital No." with the number keys.

- 6 Enter the Own digital Number with the number keys.

Note

- You must store the Own Digital Number.
- Always enter a pause before the area code.

- 7 Press [OK].

- 8 Enter the code for "Terminal Name" with the number keys.

- 9 Enter the Terminal Name.

Reference

For how to enter characters, see P.319 "Entering and Modifying Text".

- 10 Press [OK].
- 11 Press [PrevMenu].

- 6 Press [PrevMenu] three times.

- 7 Press [Exit] to return to the stand-by mode.

Registering ID Codes

Use this procedure to register the following kinds of ID code:

❖ **Confidential ID**

This ID is usually required for printing a message received with the Confidential Reception feature. ⇒ P.152 "Printing a Confidential Message"

❖ **Polling ID**

This ID is required for using the Transfer Request (⇒ P.138), Transfer Station (⇒ P.106), Default ID Polling Transmission (⇒ P.134), Default ID Polling Reception (⇒ P.131), ID Transmission (⇒ P.99), and the ID Reception (⇒ P.110) functions.

❖ Memory Lock ID

This ID is required for printing a message received using the Memory Lock feature. ⇒ P.154 "Printing a File Received with Memory Lock"

❖ Remote ID

Register the ID that is entered during a remote transfer request and used as a password for the Fax On Demand feature.

! Limitation

- ❑ A Polling ID can be any combination of digits (0 - 9) and letters (A - F) except for 0000 and FFFF. When you use Transfer Request, Transfer Station, or ID Transmission, register the same ID code as that registered on the sender's machine.
- ❑ A Confidential ID and Memory Lock ID can be any a 4 digit numeric code except for 0000.
- ❑ Register a 4 digit number for the Remote ID.

1 Make sure that the machine is in standby mode.

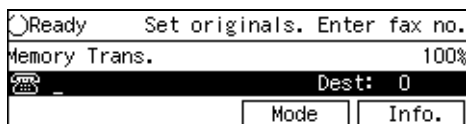

📎 Note

- ❑ If the "Fax Features" or "Key Op. Tools" screen is shown, press the [User Tools] key. If any other display is shown, press the [Clear Modes/Energy Saver] key.

2 Press the [User Tools] key.

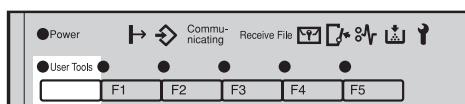

TKSS07AN

3 Enter the code for "Key Op. Tools" with the number keys. Then press the [#] key.

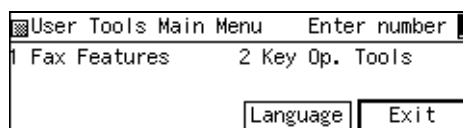

The "Fax Features" menu appears.

4 Enter the code for "System Settings" with the number keys.

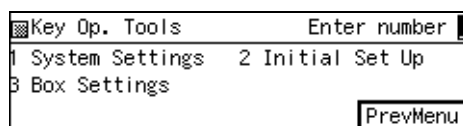

5 Enter the code for "ID Code" with the number keys.

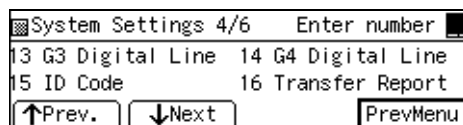

6 Enter the code of the ID you wish to register with the number keys.

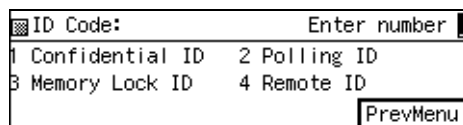

7 Enter the ID code then press [OK].

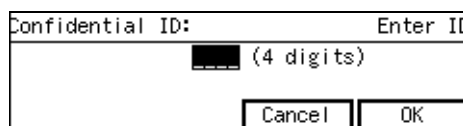

📎 Note

- ❑ For a Confidential ID, Memory Lock ID, or a Remote ID use the number keys to enter an ID code. For a Polling ID, use the number keys, and the Quick Dial keys (A to F) to enter letters.

- ❑ If you make a mistake, press the **[Clear]** key and enter the correct code.

8 Press **[PrevMenu]** three times.

9 Press **[Exit]** to return to the stand-by mode.

Transfer Report

When the optional G4 unit is installed, register the G4 fax number.

Follow these steps to store the fax number of the line your machine is connected to as the return address for when making transfer requests.

When you make a Transfer Request from this machine, this number is passed to the transfer station. The transfer station then sends back the Transfer Result Report to this fax number.

You can store the following settings:

- G3 direct number
- G3 PABX number
- G4 fax number

Limitation

- ❑ If the line in being used (i.e. communication is in progress), you cannot register or edit these settings. Please wait until the communication has finished.
- ❑ Transfer request transmission will not function unless the return address is stored.

1 Make sure that the machine is in stand-by mode.

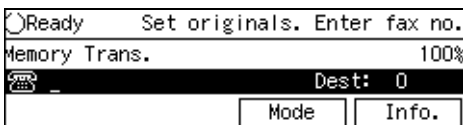

Note

- ❑ If the “Fax Features” or “Key Op. Tools” screen is shown, press the **[User Tools]** key. If any other display is shown, press the **[Clear Modes/Energy Saver]** key.

2 Press the **[User Tools]** key.

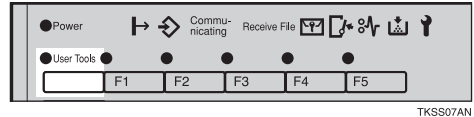

3 Enter the code for “Key Op. Tools” with the number keys. Then press the **[#]** key.

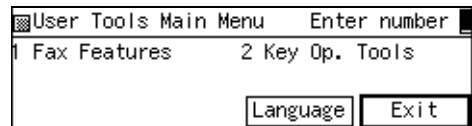

4 Enter the code for “System Settings” with the number keys.

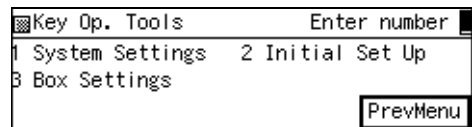

5 Enter the code for “Transfer Report” with the number keys.

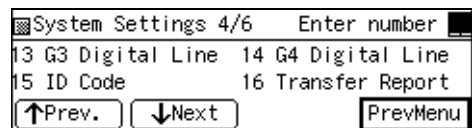

Note

- ❑ If the Item you require is not displayed, press **[↑Prev.]** or **[↓Next]** until it is.

Registering a G3 Direct Number

- 1 Enter the code for “G3 Direct Number” with the number keys.

Transfer Report	Enter number
1 G3 Direct Number	2 G3 PABX Number
3 G4 Fax Number	
PrevMenu	

- 2 Enter the fax number to use as the return address.

G3 Direct Number:	Enter own number
<input type="text"/>	
<input type="button" value="Cancel"/> <input type="button" value="OK"/>	

 **Note**

- You can store digits and pauses as the G3 Direct number.

- 3 Press [OK].

Registering a G3 PABX Number

- 1 Enter the code for “G3 PABX Number” with the number keys.

Transfer Report	Enter number
1 G3 Direct Number	2 G3 PABX Number
3 G4 Fax Number	
PrevMenu	

- 2 Enter the fax number to use as the return address.

G3 PABX Number:	Enter own number
<input type="text"/>	
<input type="button" value="Cancel"/> <input type="button" value="OK"/>	

 **Note**

- You can store digits and pauses as the G3 PABX number.

- 3 Press [OK].

Registering a G4 Fax Number

- 1 Enter the code for “G4 Fax Number” with the number keys.

Transfer Report	Enter number
1 G3 Direct Number	2 G3 PABX Number
3 G4 Fax Number	
PrevMenu	

- 2 Enter the fax number to use as the return address.

G4 Fax Number:	Enter own number
<input type="text"/>	
<input type="button" value="Cancel"/> <input type="button" value="OK"/>	

 **Note**

- You can store digits, pauses and slash (sub-address) as the G4 fax number.

- 3 Press [OK].

- 6 Press [PrevMenu] three times.

- 7 Press [Exit] to return to standby mode.

Network Settings

Use of these settings requires the optional NIC Fax Kit.

Adjust these settings to set up the Internet Fax Feature.

For details, please refer to the optional NIC Fax Kit manual.

System Parameter Transmission

This feature sends information about the condition of your machine to your nearest service representative. Follow these steps when your service representative requests you to.

Important

- This information is sent to the destination that has been registered in your machine by a customer engineer.

1 Make sure that the machine is in standby mode.

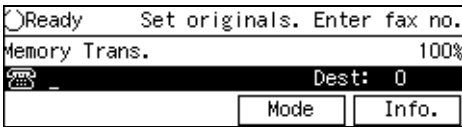

Note

- If the “Fax Features” or “Key Op. Tools” screen is shown, press the **[User Tools]** key. If any other display is shown, press the **[Clear Modes/Energy Saver]** key.

2 Press the **[User Tools]** key.

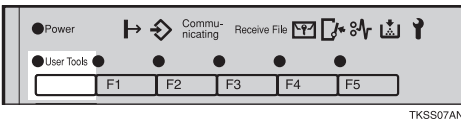

3 Enter the code for “Key Op. Tools” with the number keys. Then press the **[#]** key.

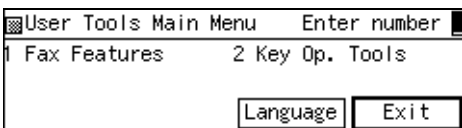

4 Enter the code for “System Settings” with the number keys.

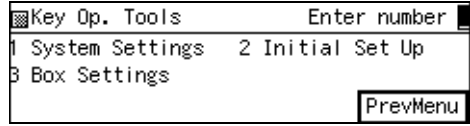

5 Enter the code for “System Param. TX” with the number keys.

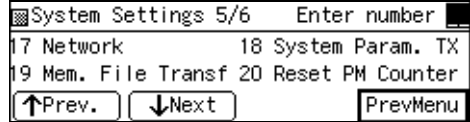

Note

- If the item require is not displayed, press **[↑Prev.]** or **[↓Next]** until it is.

6 Press the **[Start]** key.

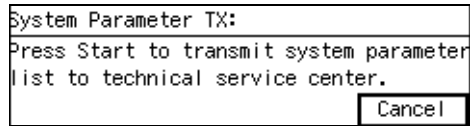

7 Press **[PrevMenu]** twice.

8 Press **[Exit]** to return to the standby mode.

Memory File Transfer

Follow this procedure if you wish to send all messages currently stored in memory to another fax and have them printed out there (e.g. if your machine cannot print for some reason).

Limitation

- You cannot choose an e-mail address as the forwarding destination.

- Even if a transmission error occurs, messages are not resent.

 **Note**

- All messages are sent in a single transmission.
- All documents are not erased from memory regardless of whether forwarding was successful or not.
- Details of the forwarding operation are not printed in the Journal.

- 1** Make sure that the machine is in standby mode.

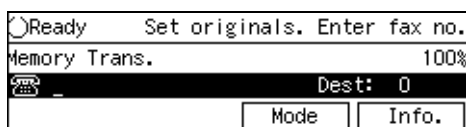

 **Note**

- If the “Fax Features” or “Key Op. Tools” screen is shown, press the **[User Tools]** key. If any other display is shown, press the **[Clear Modes/Energy Saver]** key.

- 2** Press the **[User Tools]** key.

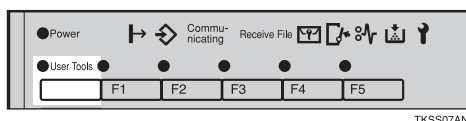

- 3** Enter the code for “Key Op. Tools” with the number keys. Then press the **[#]** key.

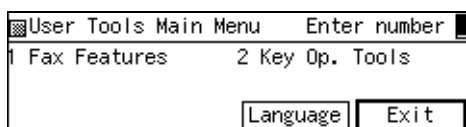

- 4** Enter the code for “System Settings” with the number keys.

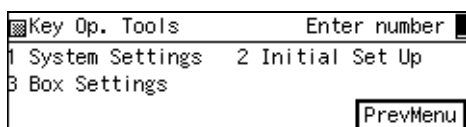

- 5** Enter the code for “Mem. File Transf” with the number keys.

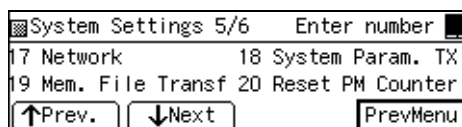

 **Note**

- If the item require is not displayed, press **[Prev.]** or **[Next]** until it is.
- If no messages are stored in memory, the following message is displayed: No matching file found.

- 6** Enter the number of the fax machine you wish to send to.

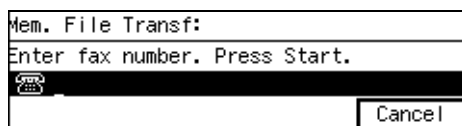

 **Note**

- If you make a mistake, press the **[Clear]** key or **[Stop]** key and try again.
- The **[Clear]** key deletes one character at a time, and the **[Stop]** key deletes the whole line.
- If you press **[Cancel]** the display in step **5** reappears.

- 7** Press the **[Start]** key.

 **Note**

- When transmission has finished, the machine will return to standby mode.

Reset PM Counters

Follow these steps when replacing the ADF Maintenance Kit or Fusing Maintenance Kit to clear the counters.

- When replacing the ADF Maintenance Kit, clear the ADF roller counter.
- When replacing the Fusing Maintenance Kit, clear the fusing unit counter and the transfer roller counter (clearing one counter will automatically clear the other).

1 Make sure that the machine is in standby mode.

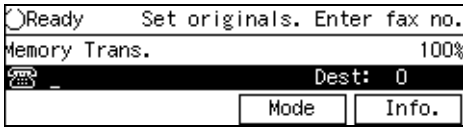

Note

- ❑ If the “Fax Features” or “Key Op. Tools” screen is shown, press the [User Tools] key. If any other display is shown, press the [Clear Modes/Energy Saver] key.

2 Press the [User Tools] key.

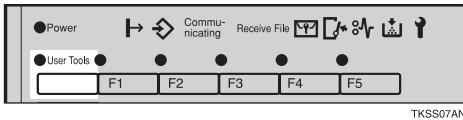

3 Enter the code for “Key Op. Tools” with the number keys. Then press the [#] key.

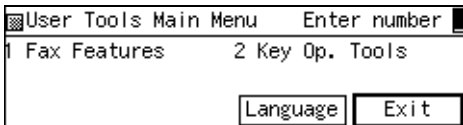

4 Enter the code for “System Settings” with the number keys.

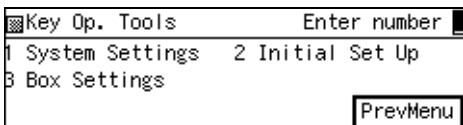

5 Enter the code for “Reset PM Counter” with the number keys.

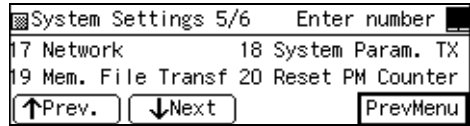

Note

- ❑ If the item you require is not displayed, press [↑Prev.] or [↓Next] until it is.

6 Press [↑Prev.] or [↓Next] until the counter you wish to clear is displayed.

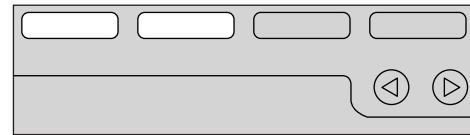
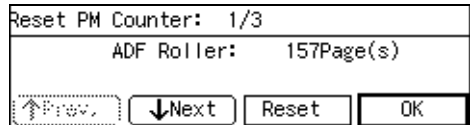

TKSS04BN

Note

- ❑ When changing the ADF Maintenance Kit, clear the ADF roller counter.
- ❑ When changing the Fusing Maintenance Kit, clear the fusing unit or transfer roller counter (clearing one counter will automatically clear the other).

7 Press [Reset].

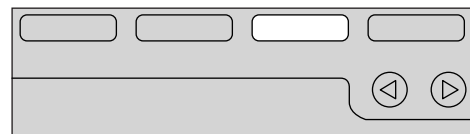
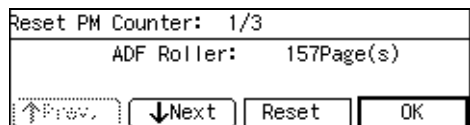

TKSS044N

Note

- If you press **[OK]**, the display in step **7** will reappear.

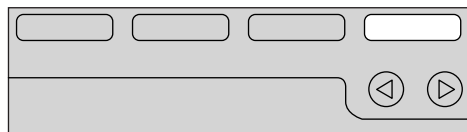
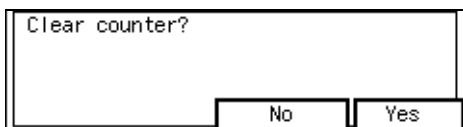
8 Press **[Yes]**.

TKSS045N

Note

- If you press **[No]**, the display in step **6** will reappear.

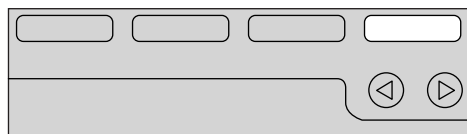
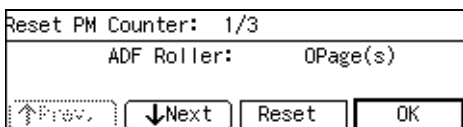
9 Press **[OK]**.

TKSS045N

If you wish to clear another counter, press **[↑Prev.]** or **[↓Next]** to select the item.

10 Press **[PrevMenu]** twice.**11** Press **[Exit]** to return to the standby mode.

RDS (Remote Diagnostic System)

If your machine has a problem, a service representative can perform various diagnostic tasks over the telephone line from the service station to try to find out what is wrong with your machine. The service technician can also use RDS to change some of your machine's settings if you request it.

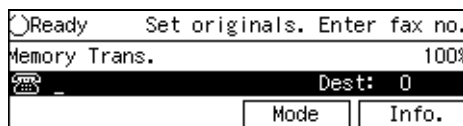
1 Make sure that the machine is in standby mode.**Note**

- If the "Fax Features" or "Key Op. Tools" screen is shown, press the **[User Tools]** key. If any other display is shown, press the **[Clear Modes/Energy Saver]** key.

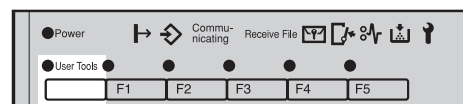
2 Press the **[User Tools]** key.

TKSS07AN

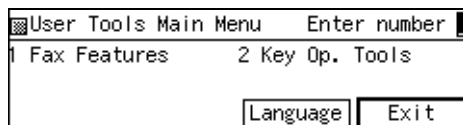
3 Enter the code for "Key Op. Tools" with the number keys. Then press the **[#]** key.

- 4** Enter the code for “System Settings” with the number keys.

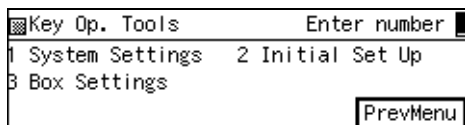

- 5** Enter the code for “RDS” with the number keys.



Note

- If the item you require is not displayed, press [↑Prev.] or [↓Next] until it is.

- 6** Press the ⏪ or ⏩ keys to turn this function on or off.

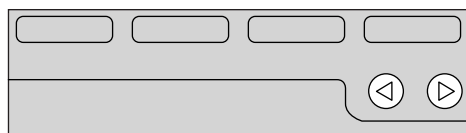
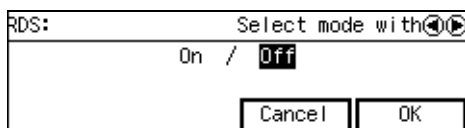

TKSS046N

- 7** Press [OK].

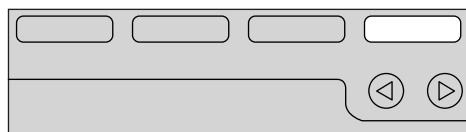
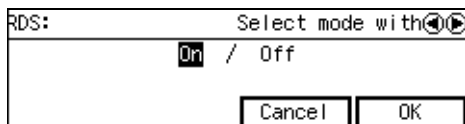

TKSS045N

- 8** Press [PrevMenu] twice.

- 9** Press [Exit] to return to the stand-by mode.

Initial Set Up

This section describes how to set up the following functions:

- “Collate” ⇒ P.276
- “Authorized Reception” ⇒ P.278
- “Specified Tray” ⇒ P.281
- “Forwarding” ⇒ P.284
- “Memory Lock” ⇒ P.292
- “TX/RX File In HD” ⇒ P.295
- “Backup File Transmission Settings” ⇒ P.300
- “Program Scan Area” ⇒ P.302

Limitation

- The above functions are not available for the e-mail reception feature provided by the optional NIC Fax Kit.

Specified Senders

All the above functions, with the exception of Backup Transmission and Program Scan Area, can be applied to all incoming messages. Alternatively, you can choose the senders from who you wish to have these functions applied to by registering the identifications of their fax machines as Specified Senders.

When registering Specified Senders, you can have the machine treat messages from these fax machines in two ways:

- Only apply the function to messages from Specified Senders, e.g. only forward messages from these fax machines.

- Apply the function to all messages except those from Specified Senders, e.g. forward all messages except those from these fax machines.

When registering a Specified Sender, you need to know the RTI or CSI that of their fax machine (if the other party's fax machine is of the same make, register their RTI, otherwise register their CSI). Ask the other party, or if you have received messages from them before, you can easily find this out by checking the Journal.

When you register or edit Specified Senders we recommend that you print the Specified Sender list and keep it nearby.

Note

- If the other party has not registered their RTI or CSI, you cannot register them as a Specified Sender.

Wildcards

The combined total number of Specified Senders that you can register for Collate, Authorized Reception, Specified Tray, Forwarding, Memory Lock and TX/RX File Save is 30 (50 when the optional function expander card is installed).

However, you can vastly increase the number of senders that are covered by using wildcards.

For example, if you wish to accept messages from all 150 branches of XYZ company (using Authorized Reception) and forward them on to head office (using Forwarding), register “XYZ” as a wildcard for each of these functions. If the RTIs of all branches contain an “XYZ” somewhere in the RTI, messages coming in from them will be accepted and sent on to head office.

Opening the Initial Set Up Menu

To access any of the function settings described in this section, you need to navigate to the Initial Set Up menu by following the steps below.

- 1 Make sure that the machine is in standby mode.

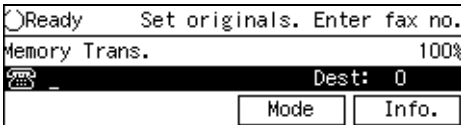

Note

- If the “Fax Features” or “User Tools” menu is shown, press the [User Tools] key. If any other display is shown, press the [Clear Modes/Energy Saver] key.

- 2 Press the [User Tools] key.

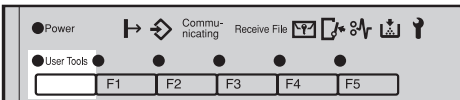

- 3 Enter the code for “Key Op. Tools” with the number keys then press the [#] key.

The “Key Operator Tools” menu appears.

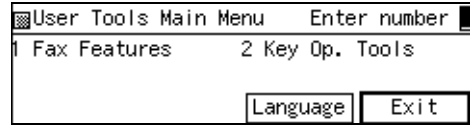

- 4 Enter the code for “Initial Set Up” with the number keys.

The “Initial Set Up” menu appears.

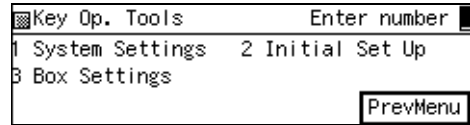

- 5 Continue from step 2 of any of the procedures described in the rest of this section.

Collate

Use this feature to have the machine print multiple copies of messages from Specified Senders. If no Specified Senders are registered, the machine prints multiple copies of all messages, regardless of the sender.

You can register the following items with the procedure below:

- Number of copies (1-9)
- Specified Senders (maximum 30 items, each G3 item can be up to 20 characters long, each G4 item can be up to 24 characters long)
- Wildcards

Limitation

- Multiple copies cannot be made of messages received using Polling Reception, Confidential Reception or Memory Lock.

Setting up Collate

Reference

For how to delete Specified Senders, see P.297 *“Deleting Specified Senders”*.

For how to print a list of Specified Senders, see P.299 *“Printing the Specified Sender List”*.

1 Bring up the “Initial Set Up” menu.

Steps **1–4**, ⇒ P.276.

2 Enter the code for “Collate” with the number keys.

Note

- If the item you require is not shown, press [↑Prev.] or [↓Next] until it is.

3 Press [Sender].

TKSS042N

Note

- If you do not wish to register a Specified Sender, proceed to step **4**.

4 Enter the code for “Program Sender” with the number keys.

Note

- If you do not register any Specified Senders, multiple copies of all incoming messages will be made.

5 Enter the 2-digit code of the Specified Sender you wish to register with the number keys.

Note

- If you make a mistake, press the [Clear] key and try again.

6 Press [RTI/CSI].

TKSS042N

7 Enter the RTI or CSI of the other party's fax machine you wish to register as a Specified Sender.

Reference

P.319 "Entering and Modifying Text"

8 Press [OK].

9 Choose whether to store this item as a wildcard.

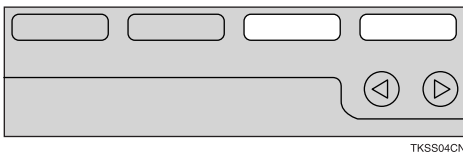
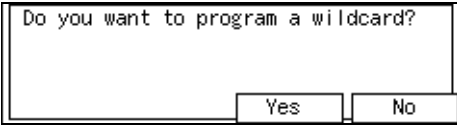

TKSS04CN

Reference

P.275 "Wildcards"

10 Press [OK].

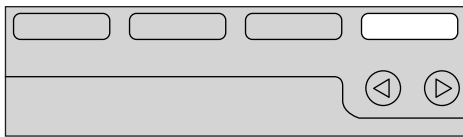
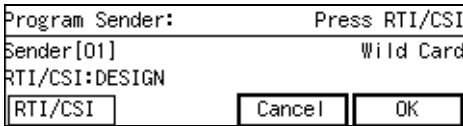

TKSS045N

11 Press [PrevMenu].

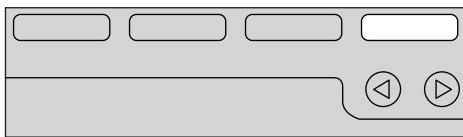
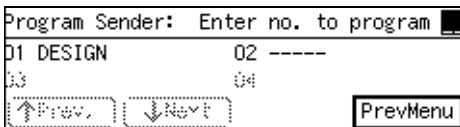

TKSS045N

Note

- To register another Specified Sender, continue from step 5.

12 Press [Exit].

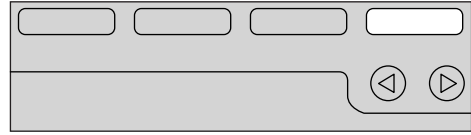
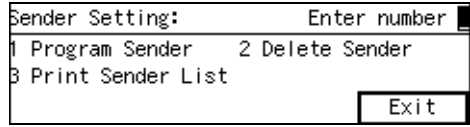

TKSS045N

13 Enter the number of copies of messages you require printed with the number keys.

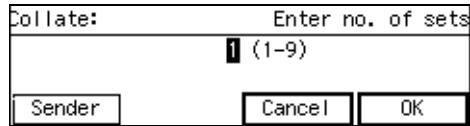

Note

- You can have 1-9 copies made.
- Values of 2 and above are valid settings for Multi-copy Reception.

14 Press [OK].

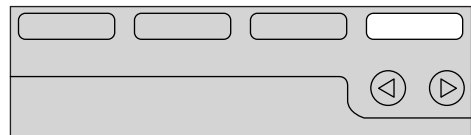
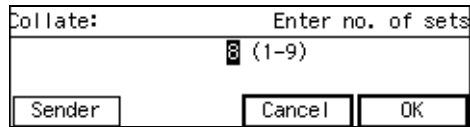

TKSS045N

15 Press [PrevMenu] twice.

16 Press [Exit].

Note

- The standby display reappears.

Authorized Reception

You can block out incoming messages from certain fax machines by registering them as Specified Senders. If a fax machine from which you do not wish to receive messages from tries to send you a message, the line is disconnected immediately after the connection is established. This feature is useful, for example, if you wish to block out junk faxes.

You can register the following items:

- Specified Senders (maximum 30 items, each G3 item can be up to 20 characters long, each G4 item can be up to 24 characters long)
- Wildcards

Important

- It is recommended that you print the Sender/Authorized Reception list keep it when you register or change a sender. ⇒ P.299 *Printing the Specified Sender List*

Limitation

- You cannot register a Specified Sender who does not have an RTI or CSI.

Note

- You can choose to receive messages from Specified Senders only, or from all senders except those registered as Specified Senders. Adjust this setting with the User Parameters. When shipped, the default setting is “Only Receive Messages From Specified Senders”.
- You can edit these settings using the same procedure as used for registering them.

Setting up Authorized Reception

Reference

For how to delete Specified Senders, see P.297 *Deleting Specified Senders*.

- 1 Bring up the “Initial Set Up” menu.

Steps 1–4, ⇒ P.276.

- 2 Enter the code for “Authorized RX” with the number keys.

Initial Set Up 1/2 Enter number

1 Collate	2 Authorized RX
3 Specified Tray	4 Forwarding

↑Prev. ↓Next PrevMenu

Note

- If the item you require is not shown, press [↑Prev.] or [↓Next] until it is.

- 3 Press [Sender].

Authorized RX: Select mode with

On / Off

Sender Cancel OK

TKSS042N

Note

- If you do not wish to register a Specified Sender, proceed to step 4.

- 4 Enter the code for “Program Sender” with the number keys.

Sender Setting: Enter number

1 Program Sender	2 Delete Sender
3 Print Sender List	

Exit

! Limitation

- If you do not register any Specified Senders, you cannot set up this function.

5 Enter the 2-digit code of the Specified Sender you wish to register with the number keys.



Note

- If you make a mistake, press the [Clear] key and try again.

6 Press [RTI/CSI].

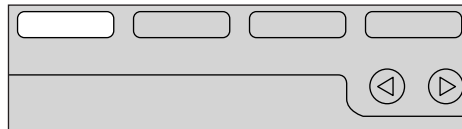
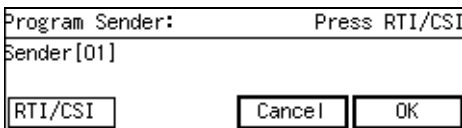

TKSS042N

7 Enter the RTI or CSI of the other party's fax machine you wish to register as a Specified Sender.

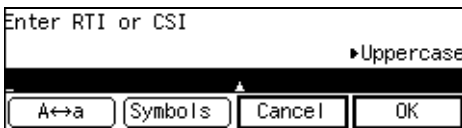

Reference

P.319 "Entering and Modifying Text"

8 Press [OK].

9 Choose whether to store this item as a wildcard.

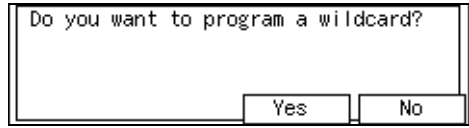

TKSS04CN

Reference

P.275 "Wildcards"

10 Press [OK].

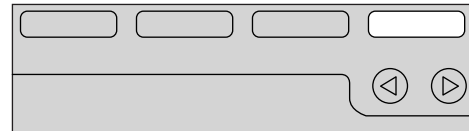
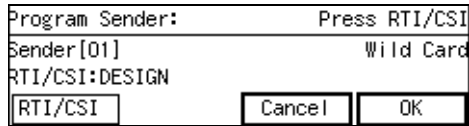

TKSS045N

11 Press [PrevMenu].

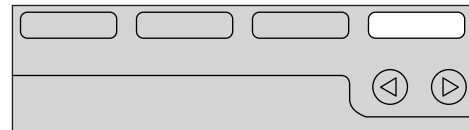
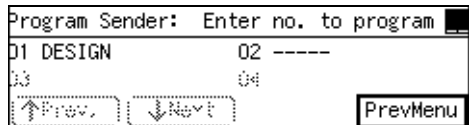

TKSS045N

Note

- To register another Specified Sender, continue from step 5.

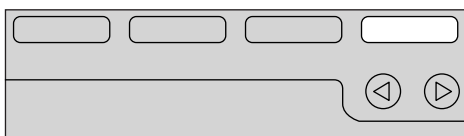
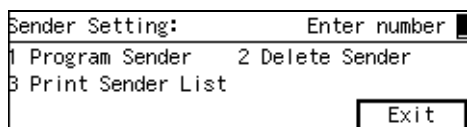
12 Press [Exit].

TKSS045N

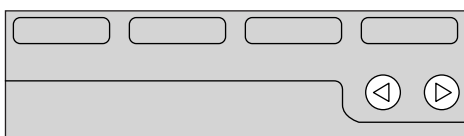
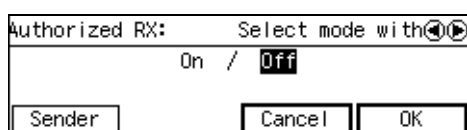
13 Press the ◀ or ▶ keys to turn this function on or off.

TKSS046N

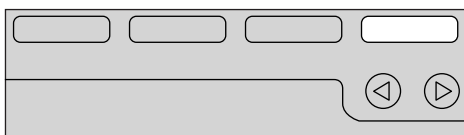
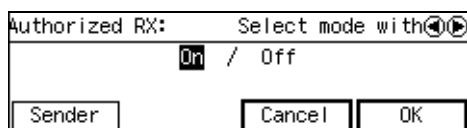
14 Press [OK].

TKSS045N

15 Press [PrevMenu] twice.**16** Press [Exit].**Note**

- The standby display reappears.

Specified Tray

This function requires the optional Paper Supply Unit.

Use this function to have messages from Specified Senders printed on different paper from that used to print messages from all other senders.

For example, imagine green paper is set in the main paper tray, and white paper is set in the optional Paper Supply Unit. By choosing to have messages from Specified Senders printed on green paper and all others printed on white paper, you can distinguish between them at a glance.

You can register the following items:

- Specified Senders (maximum 30 items, each G3 item can be up to 20 characters long, each G4 item can be up to 24 characters long)
- Wildcards

Important

- When storing Specified Senders, it is a good idea to print out the Specified Sender list to check on which numbers are currently stored. ⇒ P.299 "Printing the Specified Sender List"

Limitation

- If messages from Specified Senders are received using Polling Reception or Free Polling Reception, this feature is not available.

Note

- You can choose to have only messages from Specified Senders printed on paper from the main paper tray, or all messages except those from Specified Senders. Adjust this setting with the User Parameters. When shipped, the default setting is Only Print Messages From Specified Senders Using the Main Paper Tray.

- ❑ When one optional Paper Supply Unit is installed, load the Paper Supply Unit with paper of the same size as that loaded in the Main Paper Tray. When two Paper Supply Units are installed, load the Main Paper Tray with paper of the same width as the widest of the paper sizes loaded in the Paper Supply Units.
- ❑ If you do not set paper in the way outlined above, Substitute Reception may take place even if paper is set.
- ❑ You can edit these settings using the same procedure as used for registering them.

Setting up Specified Tray

Reference

For how to delete Specified Senders, see P.297 “Deleting Specified Senders”.

1 Bring up the “Initial Set Up” menu.

Steps **1-4**, ⇒ P.276.

2 Enter the code for “Specified Tray” with the number keys.

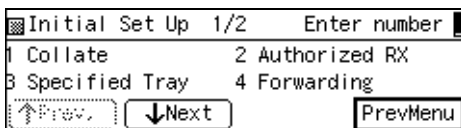

Note

- ❑ If the item you require is not shown, press [↑Prev.] or [↓Next] until it is.

3 Press [Sender].

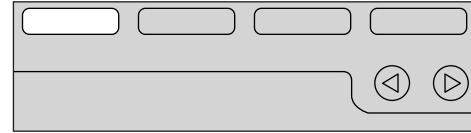
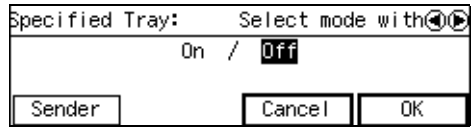

TKSS042N

Note

- ❑ If you do not wish to register a Specified Sender, proceed to step **4**.

4 Enter the code for “Program Sender” with the number keys.

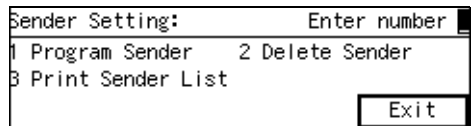

Note

- ❑ If you do not register any Specified Senders, all incoming faxes will be printed on different paper.

5 Enter the 2-digit code of the Specified Sender you wish to register with the number keys.

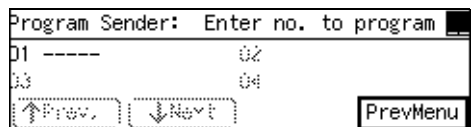

Note

- ❑ If you make a mistake, press the [Clear] key and try again.

6 Press [RTI/CSI].

Program Sender:	Press RTI/CSI
Sender [01]	
RTI/CSI	Cancel OK

TKSS042N

10 Press [OK].

Program Sender:	Press RTI/CSI
Sender [01]	Wild Card
RTI/CSI:DESIGN	
RTI/CSI	Cancel OK

TKSS045N

7 Enter the RTI or CSI of the other party's fax machine you wish to register as a Specified Sender.

Enter RTI or CSI	UpperCase
A↔a Symbols Cancel OK	

Reference

P.319 "Entering and Modifying Text"

8 Press [OK].**9** Choose whether to store this item as a wildcard.

Do you want to program a wildcard?	
Yes	No

TKSS04CN

Reference

P.275 "Wildcards"

11 Press [PrevMenu].

Program Sender:	Enter no. to program
01 DESIGN	02 ----
03	04
↑Prev.	↓Next
PrevMenu	

TKSS045N

Note

- To register another Specified Sender, continue from step **5**.

12 Press [Exit].

Sender Setting:	Enter number
1 Program Sender	2 Delete Sender
3 Print Sender List	
Exit	

TKSS045N

13 Press the ◀ or ▶ keys to turn this function on or off.

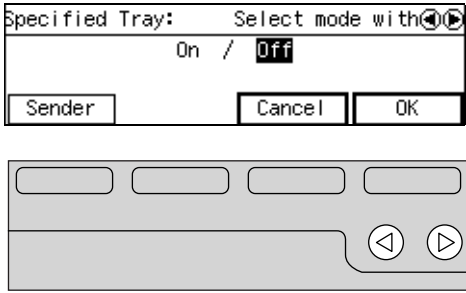

14 Press [OK].

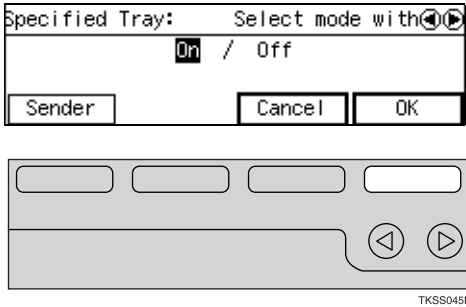

15 Press [PrevMenu] twice.

16 Press [Exit].

Note

- The standby display reappears.

Forwarding

With this feature, messages from Specified Senders are printed then forwarded to a pre-registered destination (referred to here as the Forwarding Address). For example, if you are away on a trip, you can have messages automatically sent to where you are staying.

You can register the following items:

- Forwarding Addresses (up to 5 fax numbers, each fax number up to 254 digits long)

- Specified Senders (10 items for each Forwarding Address up to a combined maximum of 30 items for all Forwarding Addresses, 50 items when the optional Function Upgrade Card is installed. Each G3 item can be up to 20 characters long, each G4 item can be up to 24 characters long).

- Wildcards

Important

- When you register or edit Specified Senders we recommend that you print the Forwarding Address List and keep it nearby. ⇒ P.291 *“Printing the Specified Sender List (Forwarding)”*

Limitation

- Messages received using Confidential Reception, Memory Lock, Polling Reception, or messages sent using Transfer Request from another fax cannot be forwarded.
- Register the RTI or CSI of the other party as the Specified Sender. If the other party has not registered their RTI or CSI, you cannot register them as a Specified Sender and forwarding is not possible.

Note

- You can choose to forward only messages from Specified Senders or forward all messages except those from Specified Senders. Adjust this setting with the User Parameters. When shipped, the default setting is “Only Forward Messages From Specified Senders”.
- You can choose whether the machine prints out messages it forwards with the User Parameters (⇒ P.250). When shipped, the default setting is “On”.

- ❑ You can edit these settings using the same procedure as used for registering them.

❖ Forwarding Mark

You can have a mark stamped on documents to indicate that they have been forwarded.

At the forwarding destination this can help distinguish between standard faxes and faxes that have been forwarded.

Note

- ❑ Turn the Forwarding Mark on or off with the User Parameters (⇒ P.250). When shipped, this feature is turned on.

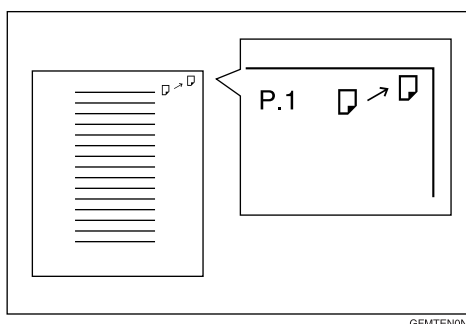

GFMTEN09

Setting up Memory Forwarding

Reference

For how to delete Specified Senders, see P.289 “Deleting Specified Senders (Forwarding)”.

1 Bring up the “Initial Set Up” menu.

Steps 1–4, ⇒ P.276.

2 Enter the code for “Forwarding” with the number keys.

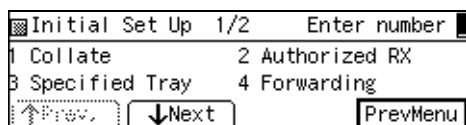

Note

- ❑ If the item you require is not shown, press [↑Prev.] or [↓Next] until it is.

3 Press [Receiver].

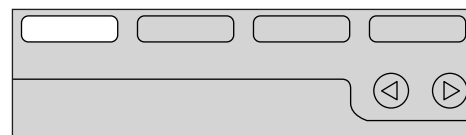
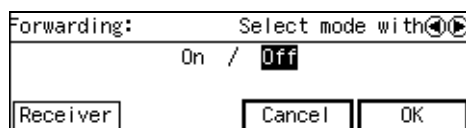

TKSS042N

4 Enter the code for “Prog. Receiver” with the number keys.

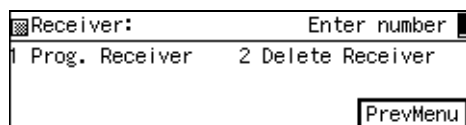

5 Enter the item number of the Forwarding Address you wish to register with the number keys.

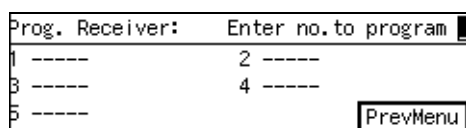

Note

- ❑ If you make a mistake, press the [Clear] key and try again.
- ❑ You can store up to 5 Forwarding Addresses.

6 Enter the fax number of the Forwarding Address with the number keys.

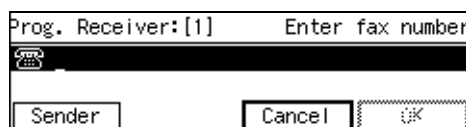

Note

- ❑ If you make a mistake, press the **[Clear]** key or **[Stop]** key and try again. The **[Clear]** key deletes one character at a time, and the **[Stop]** clears the whole line.
- ❑ When the optional NIC Fax Kit is installed, you can also enter an e-mail address.

7 Press **[Sender]**.

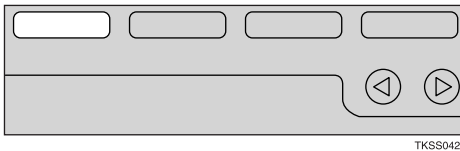
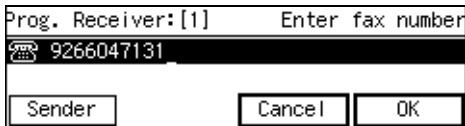

Note

- ❑ If you do not wish to register a Specified Sender, proceed to step 7.

8 Enter the code for "Program Sender" with the number keys.

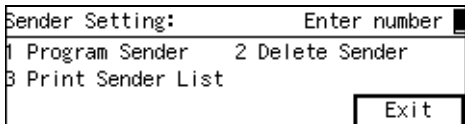

Note

- ❑ If you do not register any Specified Senders, all incoming faxes will be forwarded.

9 Enter the 2-digit code of the Specified Sender you wish to register with the number keys.



Note

- ❑ If you make a mistake, press the **[Clear]** key and try again.

10 Press **[RTI/CSI]**.

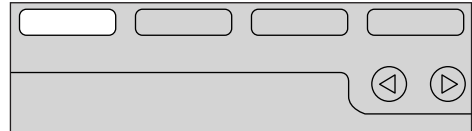
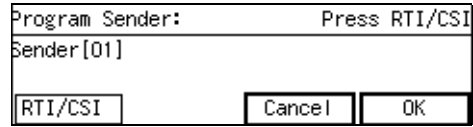

11 Enter the RTI or CSI of the other party's fax machine you wish to register as a Specified Sender.

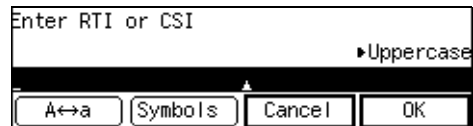

Reference

P.319 "Entering and Modifying Text"

12 Press **[OK]**.

13 Choose whether to store this item as a wildcard.

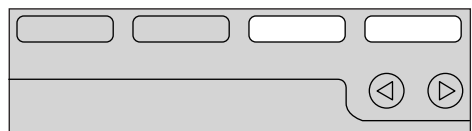
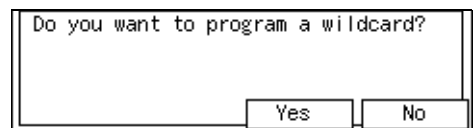

Reference

P.275 "Wildcards"

14 Press [OK].

Program Sender:	Press RTI/CSI
Sender[01]	Wild Card
RTI/CSI:DESIGN	
RTI/CSI	Cancel OK

TKSS045N

17 Press [OK].

Prog. Receiver:[1]	Enter fax number
9266047131	
Sender	Cancel OK

TKSS045N

15 Press [PrevMenu].

Program Sender:	Enter no. to program
01 DESIGN	02 -----
03	04
↑Prev.	↓Next
PrevMenu	

TKSS045N

Note

- To register another Specified Sender, continue from step 12.

16 Press [Exit].

Sender Setting:	Enter number
1 Program Sender	2 Delete Sender
3 Print Sender List	
Exit	

TKSS045N

18 Press [PrevMenu] twice.**19** Press the ◀ or ▶ keys to turn this function on or off.

Forwarding:	Select mode with
On / Off	
Receiver	Cancel OK

TKSS046N

Note

- You can choose to forward only messages from Specified Senders, or forward all messages except those from Specified Senders. Adjust this setting with the User Parameters.

20 Press [OK].

Forwarding:	Select mode with
On / Off	
Receiver	Cancel OK

TKSS045N

21 Press [PrevMenu] twice.**22** Press [Exit].

Note

- The standby display reappears.

Deleting Forwarding Addresses

1 Bring up the “Initial Set Up” menu.

Steps **1-4**, ⇒ P.276.

2 Check Enter the code for “Prog. Receiver” with the number keys.

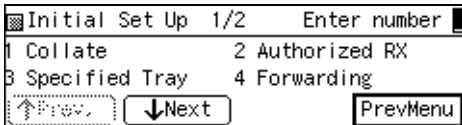

Note

- If the item you require is not shown, press [↑Prev.] or [↓Next] until it is.

3 Press [Receiver].

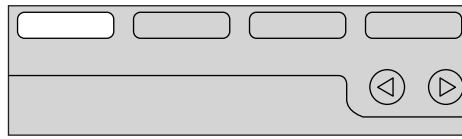
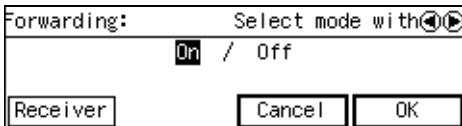

TKSS042N

4 Enter the code for “Delete Receiver” with the number keys.

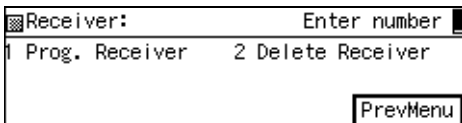

5 Enter the item number of the Forwarding Address you wish to delete with the number keys.

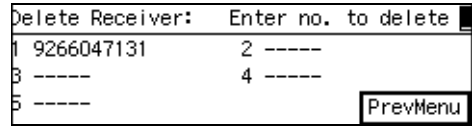

6 Press [Yes].

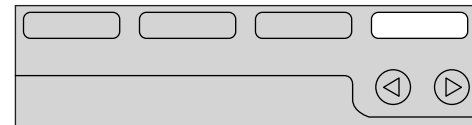
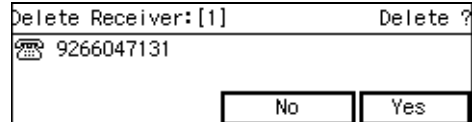

TKSS045N

Note

- If you make a mistake, or do not wish to delete this Forwarding Address, press [No]. The display in step **5** will reappear.

7 Press [Yes].

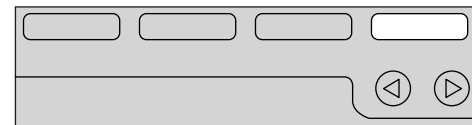
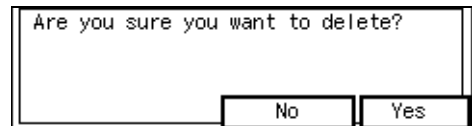

TKSS045N

Note

- If you press [No], the display in step **5** will reappear.

8 Press [PrevMenu].

Delete Receiver:	Enter no. to delete
1 ----	2 ----
3 ----	4 ----
5 ----	
PrevMenu	

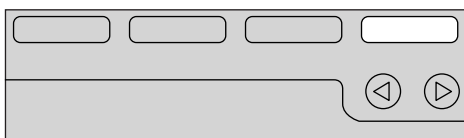
**9** Press [PrevMenu].

Receiver:	Enter number
1 Prog. Receiver	2 Delete Receiver
PrevMenu	

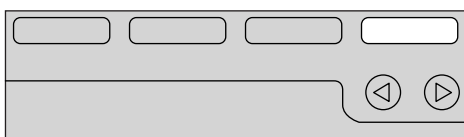
**10** Press [OK].

Forwarding:	Select mode with
On / Off	
Receiver	Cancel OK

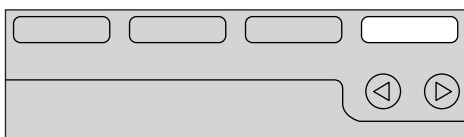
**Note**

- Select “off” when you want to invalidate setting.

11 Press [PrevMenu] twice.**12** Press [Exit].**Note**

- The standby display reappears.

Deleting Specified Senders (Forwarding)

1 Bring up the “Initial Set Up” menu.

Steps **1-4**, ⇒ P.276.

2 Enter the code for “Forwarding” with the number keys.

Initial Set Up 1/2	Enter number
1 Collate	2 Authorized RX
3 Specified Tray	4 Forwarding
↑Prev.	↓Next
PrevMenu	

Note

- If the item you require is not shown, press [↑Prev.] or [↓Next] until it is.

3 Press [Receiver].

Forwarding:	Select mode with
On / Off	
Receiver	Cancel OK

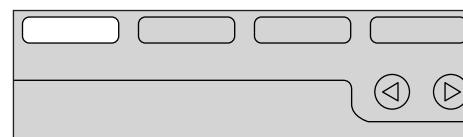
**4** Enter the code for “Prog. Receiver” with the number keys.

Receiver:	Enter number
1 Prog. Receiver	2 Delete Receiver
PrevMenu	

5 Enter the item number of the Forwarding Address whose Specified Sender you wish to delete with the number keys.

Prog. Receiver:	Enter no. to program
1 9266047131	2 ----
3 ----	4 ----
5 ----	
PrevMenu	

Note

- If you make a mistake, press the **[Clear]** key and try again.

6 Press **[Sender]**.

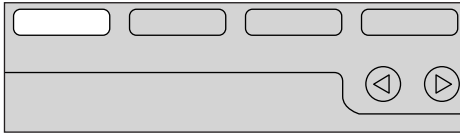
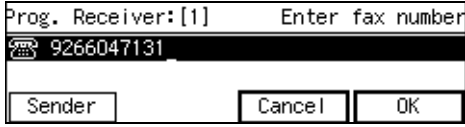

TKSS042N

7 Enter the code for "Delete Sender" with the number keys.

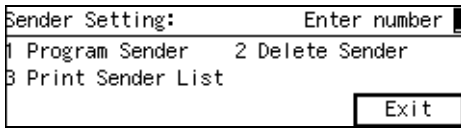

8 Enter the 2-digit code of the Specified Sender you wish to delete with the number keys.



9

Note

- If you make a mistake, press **[No]** and try again.

9 Press **[Yes]**.

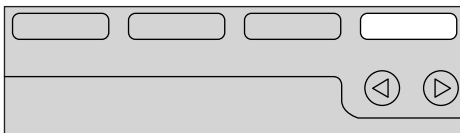
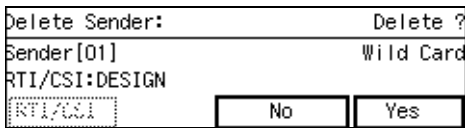

TKSS045N

Note

- If you press **[No]**, the display in step **8** will reappear.

10 Press **[Yes]**.

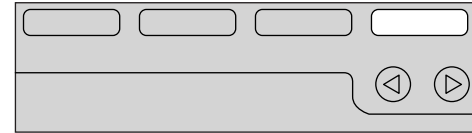
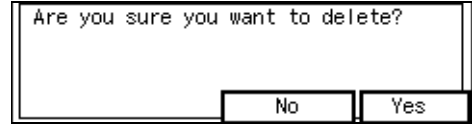

TKSS045N

Note

- If you press **[No]**, the display in step **8** will reappear.

11 Press **[PrevMenu]**.

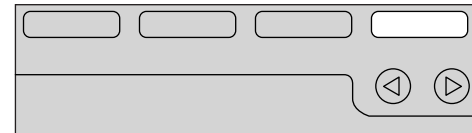
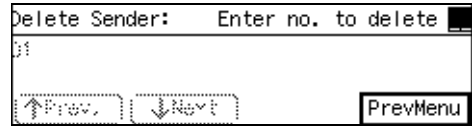

TKSS045N

Note

- To delete another Specified Sender, continue from step **11**.

12 Press **[Exit]**.

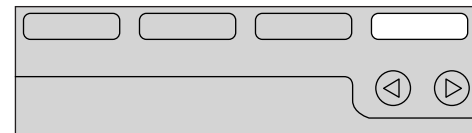
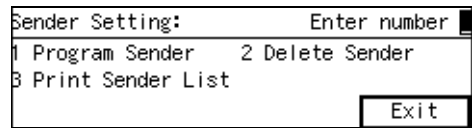

TKSS045N

- 13** Press [OK].

Prog. Receiver:[1] Enter fax number
9266047131
Sender Cancel OK

TKSS045N

- 14** Press [PrevMenu] twice.

- 15** Press [OK].

Forwarding: Select mode with [Left] [Right]
On / Off
Receiver Cancel OK

TKSS045N

Note

- Select "off" when you want to invalidate setting.

- 16** Press [PrevMenu] twice.

- 17** Press [Exit].

Note

- The standby display reappears.

Printing the Specified Sender List (Forwarding)

You can check which Specified Senders are registered for a Forwarding Address.

Follow the steps below to print this list.

- 1** Bring up the "Initial Set Up" menu.

Steps **1-4**, ⇒ P.276.

- 2** Enter the code for "Forwarding" with the number keys.

Initial Set Up 1/2 Enter number
1 Collate 2 Authorized RX
3 Specified Tray 4 Forwarding
Prev Next PrevMenu

Note

- If the item you require is not shown, press [↑Prev.] or [↓Next] until it is.

- 3** Press [Receiver].

Forwarding: Select mode with [Left] [Right]
On / Off
Receiver Cancel OK

TKSS042N

- 4** Enter the code for "Prog. Receiver" with the number keys.

Receiver: Enter number
1 Prog. Receiver 2 Delete Receiver
PrevMenu

- 5** Enter the item number of the Forwarding Address you wish to print out with the number keys.

Prog. Receiver: Enter no. to program
1 9266047131 2 ----
3 ---- 4 ----
5 ----
PrevMenu

- 6** Press [Sender].

Prog. Receiver:[1] Enter fax number
9266047131
Sender Cancel OK

- 7** Enter the code for “Print Sender List” with the number keys.

Sender Setting:	Enter number
1 Program Sender	2 Delete Sender
3 Print Sender List	
Exit	

- 8** Press the [Start] key.

To print list, press Start.	Cancel
--------------------------------	--------

Note

- To stop the list being printed, press [Cancel]. The display in step 7 reappears.

- 9** Press [Exit].

Sender Setting:	Enter number
1 Program Sender	2 Delete Sender
3 Print Sender List	
Exit	

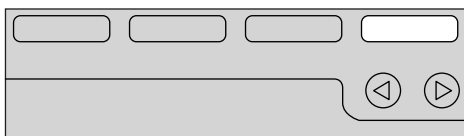

TKSS045N

- 10** Press [OK].

Prog. Receiver: [1]	Enter fax number	
9266047131		
Sender	Cancel	OK

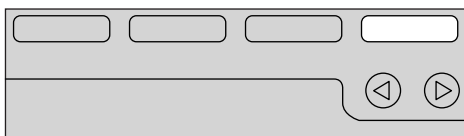

TKSS045N

- 11** Press [PrevMenu] twice.

- 12** Press [OK].

- 13** Press [PrevMenu] twice.

- 14** Press [Exit].

Note

- The standby display reappears.

Memory Lock

You can have only messages from Specified Senders received using Memory Lock. Register these senders. If you do not register any Specified Senders, all incoming messages are received using Memory Lock.

Preparation

Be sure to register the Memory Lock ID beforehand. ⇒ P.266 “Registering ID Codes”

You can register the following items:

- Specified Senders (maximum 30 items, each G3 item can be up to 20 characters long, each G4 item can be up to 24 characters long)
- Wildcards

Limitation

- Memory Lock is not available with manual reception.

Note

- You can choose to only lock messages from Specified Senders, or lock all messages except those from Specified Senders. Adjust this setting with the User Parameters. When shipped, the default setting is “Only Lock Messages From Specified Senders”. ⇒ P.250 “Changing the User Parameters”
- You can edit these settings using the same procedure as used for registering them.

Setting up Memory Lock

Reference

For how to delete Specified Senders, see P.297 *“Deleting Specified Senders”*.

For how to print a list of Specified Senders, see P.299 *“Printing the Specified Sender List”*.

1 Bring up the “Initial Set Up” menu.

Steps 1–4, ⇒ P.276.

2 Enter the code for “Memory Lock” with the number keys.

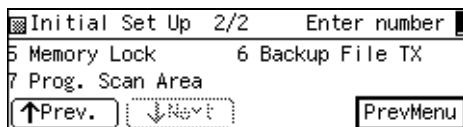

Note

- If the item you require is not shown, press [↑Prev.] or [↓Next] until it is.

3 Press [Sender]

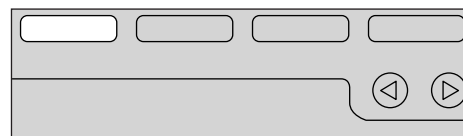
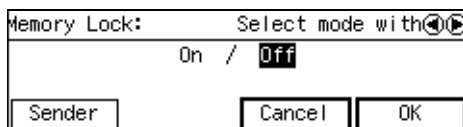

Note

- If you do not wish to register a Specified Sender, proceed to step 4.

4 Enter the code for “Program Sender” with the number keys.

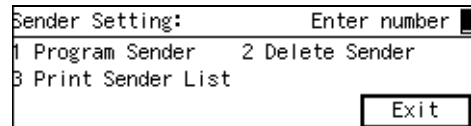

Note

- If you do not register any Specified Senders, all incoming faxes will be locked in memory.

5 Enter the 2-digit code of the Specified Sender you wish to register with the number keys.

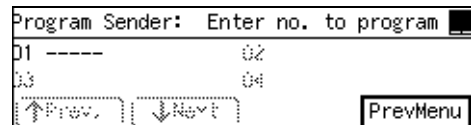

Note

- If you make a mistake, press the [Clear] key and try again.

6 Press [RTI/CSI].

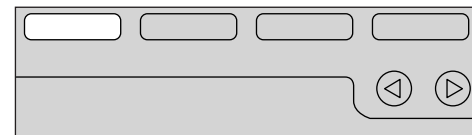
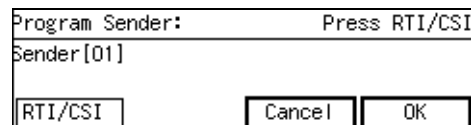

7 Enter the RTI or CSI of the other party's fax machine you wish to register as a Specified Sender.

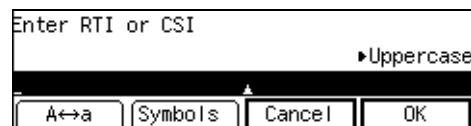

Reference

P.319 *“Entering and Modifying Text”*

8 Press [OK].

9 Choose whether to store this item as a wildcard.

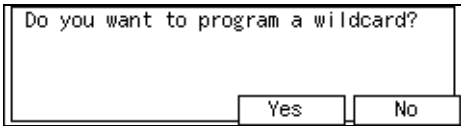

TKSS04CN

Reference

P.275 "Wildcards"

10 Press [OK].

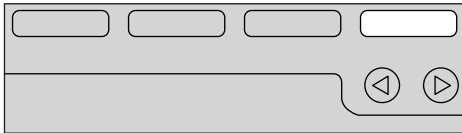
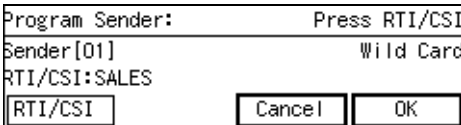

TKSS045N

11 Press [PrevMenu].

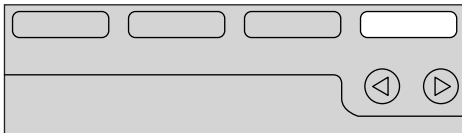
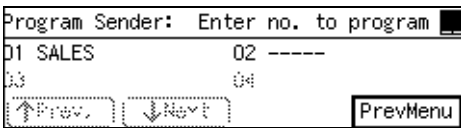

TKSS045N

Note

- To register another Specified Sender, continue from step **8**.

12 Press [Exit].

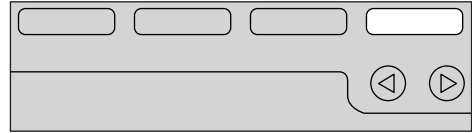
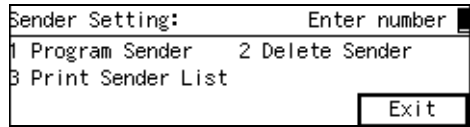

TKSS045N

13 Press the **◀** or **▶** keys to turn this function on or off.

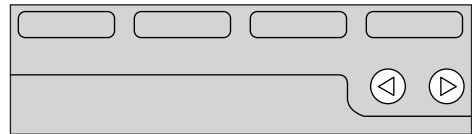
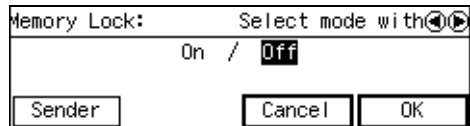

TKSS046N

Note

- You can choose to only lock messages from Specified Senders, or lock all messages except those from Specified Senders. Adjust this setting with the User Parameters.

14 Press [OK].

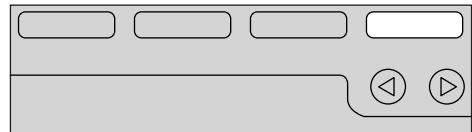
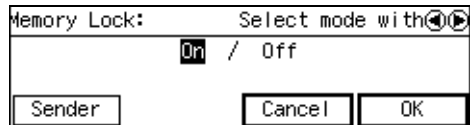

TKSS045N

15 Press [PrevMenu] twice.

16 Press [Exit].

Note

- The standby display reappears.

TX/RX File In HD

This function requires the optional Function Upgrade Card and optional 40M Expanded Memory Card.

Use this function to have messages from Specified Senders received using the TX/RX File In HD function. If you do not register any Specified Senders, all messages will be received using the TX/RX File In HD function. ⇒ P.160 “TX/RX File Save”

You can register the following items:

- Specified Senders (maximum 30 items, each G3 item can be up to 20 characters long, each G4 item can be up to 24 characters long)
- Wildcards

Note

- You can choose to forward only messages from Specified Senders, or forward all messages except those from Specified Senders. Adjust this setting with the User Parameters. When shipped, the default setting is “Only Apply To Messages From Specified Senders”.
- You can edit these settings using the same procedure as used for registering them.

Setting up TX/RX File In HD

Reference

For how to delete Specified Senders, see P.297 “Deleting Specified Senders”.

For how to print a list of Specified Senders, see P.299 “Printing the Specified Sender List”.

1 Bring up the “Initial Set Up” menu.

Steps **1-4**, ⇒ P.276.

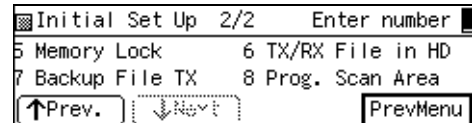
2 Enter the code for “TX/RX File In HD” with the number keys.**Note**

- If the item you require is not shown, press [↑Prev.] or [↓Next] until it is.

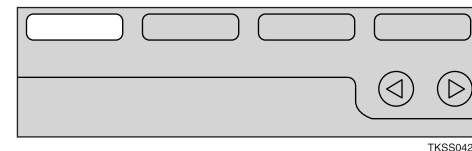
3 Press [Sender].

TKSS042N

Note

- If you do not wish to register a Specified Sender, proceed to step **4**.

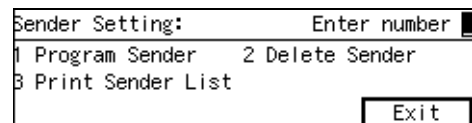
4 Enter the code for “Program Sender” with the number keys.

Note

- ❑ If you do not register any Specified Senders, all incoming faxes will be received using TX/RX File In HD.

5 Enter the 2-digit code of the Specified Sender you wish to register with the number keys.

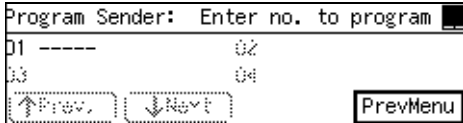

Note

- ❑ If you make a mistake, press the [Clear] key and try again.

6 Press [RTI/CSI].

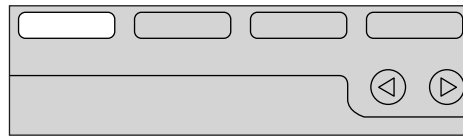
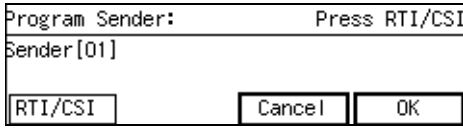

TKSS042N

7 Enter the RTI or CSI of the other party's fax machine you wish to register as a Specified Sender.

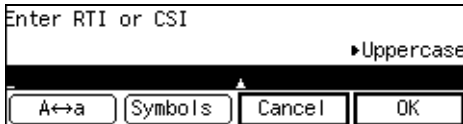

Reference

P.319 "Entering and Modifying Text"

8 Press [OK].

9 Choose whether to store this item as a wildcard.

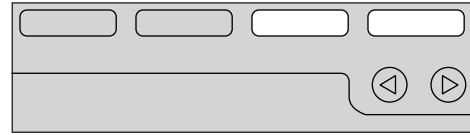
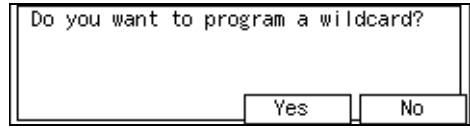

TKSS04CN

Reference

P.275 "Wildcards"

10 Press [OK].

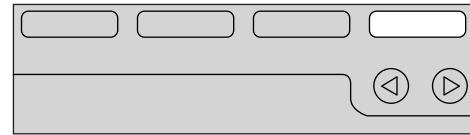
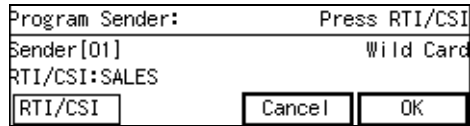

TKSS045N

11 Press [PrevMenu].

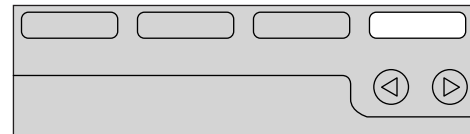
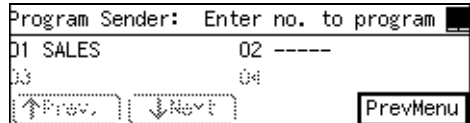

TKSS045N

Note

- ❑ To register another Specified Sender, continue from step 5.

12 Press [Exit].

Sender Setting:		Enter number
1 Program Sender	2 Delete Sender	
3 Print Sender List		
		Exit

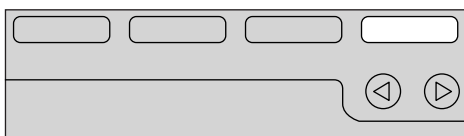

TKSS045N

13 Press the ◀ or ▶ keys to turn this function on or off.

TX/RX File In HD:		Select mode with
On / Off		
Sender	Cancel	OK

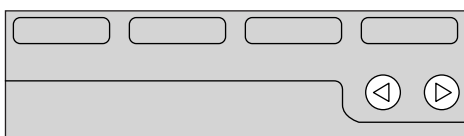

TKSS046N

Note

- ❑ You can choose to save only messages from Specified Senders, or save all messages except those from Specified Senders. Adjust this setting with the User Parameters.

14 Press [OK].

TX/RX File In HD:		Select mode with
On / Off		
Sender	Cancel	OK

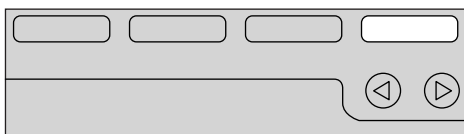

TKSS045N

15 Press [PrevMenu] twice.

16 Press [Exit].

Note

- ❑ The standby display reappears.

Deleting Specified Senders

Use this procedure to delete Specified Senders for the following features:

Reference

“Collate” ⇒ P.276

“Authorized Reception” ⇒ P.278

“Specified Tray” ⇒ P.281

“Memory Lock” ⇒ P.292

“TX/RX File In HD” ⇒ P.295

“Backup File Transmission Settings” ⇒ P.300

“Program Scan Area” ⇒ P.302

Note

- ❑ For how to delete Specified Senders for the Forwarding function, see P.289 “Deleting Specified Senders (Forwarding)”.

How to delete Specified Senders

The example below describes how to delete Specified Senders for the Collate feature. The procedure for other functions is identical except for steps **1** and **2**.

1 Bring up the “Initial Set Up” menu.

Steps **1-4**, ⇒ P.276.

2 Enter the code for “Collate” with the number keys.

Initial Set Up 1/2		Enter number
1 Collate	2 Authorized RX	
3 Specified Tray	4 Forwarding	
↑Prev.	↓Next	PrevMenu

Note

- ❑ If the item you require is not shown, press [↑Prev.] or [↓Next] until it is.

3 Press [Sender].

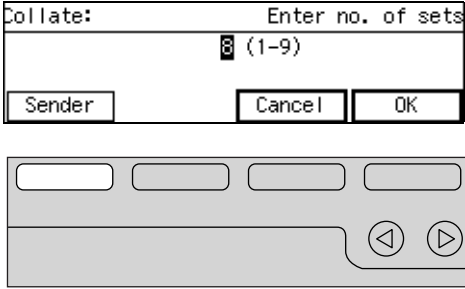

TKSS042N

4 Enter the code for "Delete Sender" with the number keys.

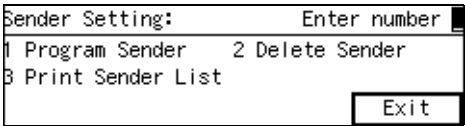

5 Enter the 2-digit code of the Specified Sender you wish to register with the number keys.

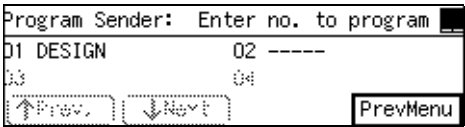

Note

- ❑ If you make a mistake, press the [Clear] key and try again.

6 Press [Yes].

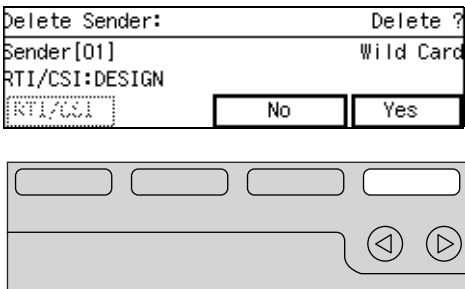

TKSS045N

Note

- ❑ If you press [No], the display in step 6 reappears.

7 Press [Yes].

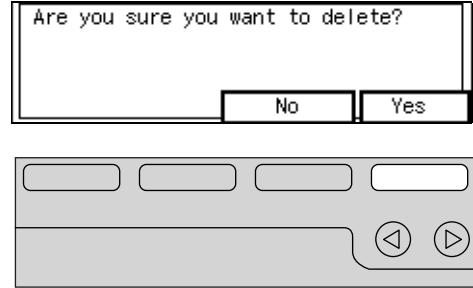

TKSS045N

Note

- ❑ If you press [No], the display in step 5 reappears.

8 Press [PrevMenu].

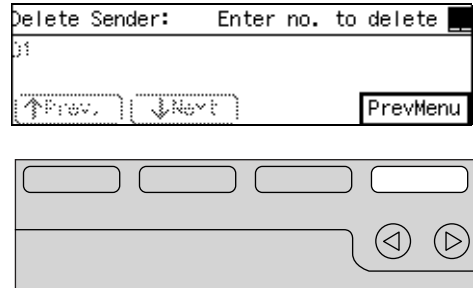

TKSS045N

Note

- ❑ To delete more Specified Senders, go back to step 5.

9 Press [Exit].

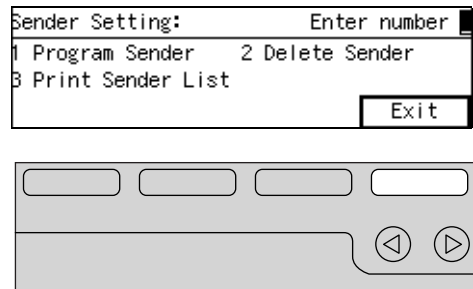

TKSS045N

10 Press [OK].

TKSS045N

Note

- Select "off" when you want to invalidate setting.

11 Press [PrevMenu] twice.

12 Press [Exit].

Note

- The standby display reappears.

Printing the Specified Sender List

Follow the steps below to print a single-page list of Specified Senders registered for each of the following features:

Reference

- "Collate" ⇒ P.276
- "Authorized Reception" ⇒ P.278
- "Specified Tray" ⇒ P.281
- "Memory Lock" ⇒ P.292
- "TX/RX File In HD" ⇒ P.295
- "Backup File Transmission Settings" ⇒ P.300
- "Program Scan Area" ⇒ P.302

How to Print Specified Sender List

The example below describes how to print Specified Senders List for the Collate feature. The procedure for other functions is identical except for steps **3** and **4**.

1 Bring up the "Initial Set Up" menu.

Steps **1-4**, ⇒ P.276.

2 Enter the code for "Collate" with the number keys.

Note

- If the item you require is not shown, press [↑Prev.] or [↓Next] until it is.

3 Press [Sender].

TKSS042N

4 Enter the code for "Print Sender List" with the number keys.

5 Press the **[Start]** key.

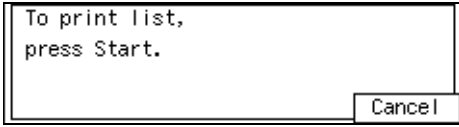

Note

- To cancel printing, press **[Cancel]**. The display in step **4** will reappear.

6 Press **[Exit]**.

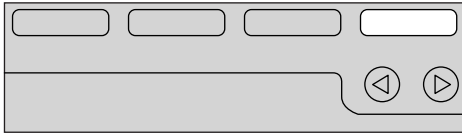
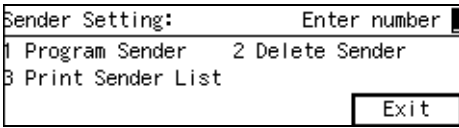

TKSS045N

7 Press **[OK]**.

8 Press **[PrevMenu]** twice.

9 Press **[Exit]**.

Backup File Transmission Settings

By registering a destination for administrative use you can automatically have backups made of all sent faxes.

You can register the following items:

- Administrators Address
Store a single fax number, or an e-mail address (option required).
- Administrator Name

Backup Transmission applies to the following features:

- Memory Transmission
- Transfer Request Transmission

- Confidential Transmission
- SUB Code Transmission
- E-mail Transmission (optional NIC Fax Kit required)

Limitation

- You cannot specify the administrator address using a Quick Dial or Speed Dial.
- Immediate Transmission is not available when Backup Transmission is turned on.
- If memory runs out while a message is on transmission standby, or cannot be sent documents, transmission cannot take place.

Note

- You check the result of a Backup Transmission by reading the Memory Communication Result Report (Memory Transmission).

1 Bring up the “Initial Set Up” menu.

Steps **1-4**, ⇒ P.276.

2 Enter the code for “Backup File TX” with the number keys.

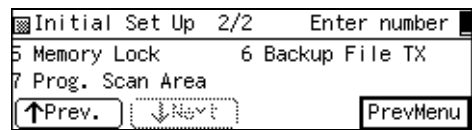

Note

- If the item you require is not shown, press **[↑Prev.]** or **[↓Next]** until it is.

- 3** Press the **◀** or **▶** keys to turn this function on or off.

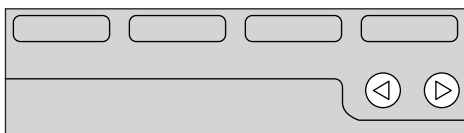
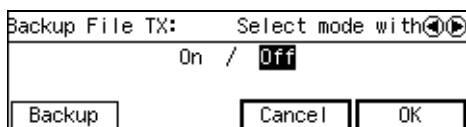

TKSS046N

- 4** Press **[Backup]**.

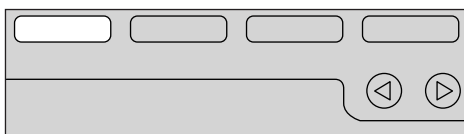
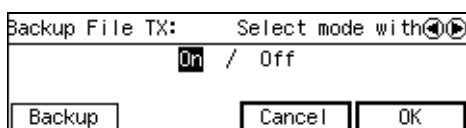

TKSS042N

- 5** Enter the fax number of the backup destination (Administrator Address).

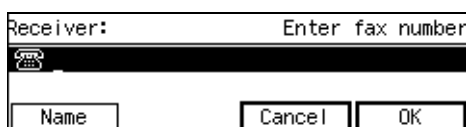

Note

- If the optional NIC Fax Kit is installed, you can press the User Function Key (**[F1]**-**[F5]**) with the Mail Address function registered in it and enter an e-mail address. ⇒ optional NIC Fax Kit manual

Registering/Editing the administrator name

- 1** Press **[Name]**.

- 2** Enter a name for the administrator address.

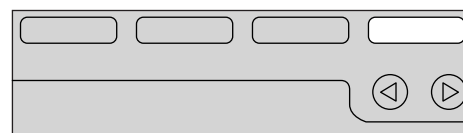
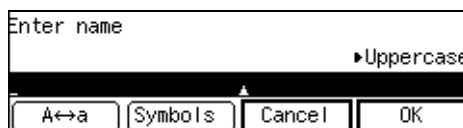

TKSS045N

Reference

P.319 "Entering and Modifying Text"

- 3** Press **[OK]**.

- 6** Press **[OK]**.

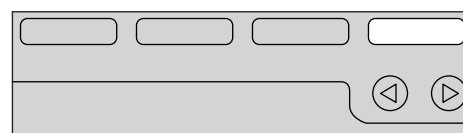
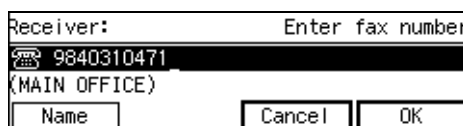

TKSS045N

- 7** Press **[OK]**.

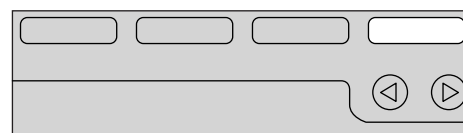
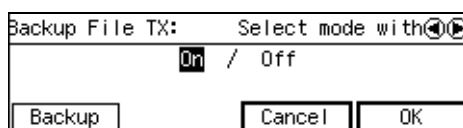

TKSS045N

- 8** Press **[PrevMenu]** twice.

- 9** Press **[Exit]**.

Note

- The standby display reappears.

Program Scan Area

This function requires the optional Function Upgrade Card.

If you register the scan area beforehand, only the area of documents you have specified will be scanned in and sent.

Transmission time is shorter compared to sending the whole page. This feature is useful, for example, when you do not need to send the whole page, or when the page contains confidential information.

Preparation

You must store the Scan Area feature in a User Function key (**[F1]** – **[F5]**) beforehand. Press this key to turn Scan Area on and off.

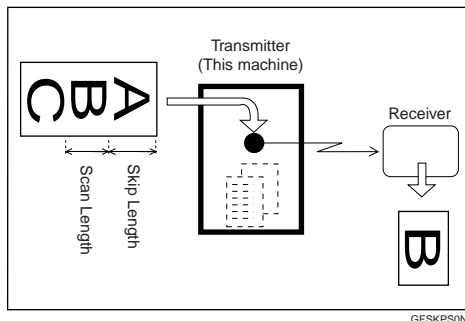

- **Skip Length**
The length that is not scanned measured from the leading edge. E.g. if you set it to 50 mm, the area 50 mm from the leading edge is not scanned in.
- **Scan Length**
The length of the area to be scanned. E.g. if you set it to 120 mm, an area 120 mm long starting at the end of the skip length will be scanned.

- You can use Scan Area with Memory Transmission (including Confidential Transmission and Transfer Request Transmission), Polling Transmission, Free Polling Transmission, SUB Code Transmission, and when registering Auto Documents.

Limitation

- You can only store one scan area.
- The area up to about 2 mm from the leading edge cannot be scanned no matter how you set the skip length.
- The area up to about 3 mm from the trailing edge cannot be scanned no matter how you set the skip length.
- If you try and scan in a document that is shorter than the skip length, the operation is canceled and the document is erased from memory.

Note

- The skip length can be in the range 0–499 mm. The default when shipped is 0 mm. However, the area up to about 2 mm from the leading edge cannot be scanned no matter how you set the skip length.
- The scan length can be in the range 0–499 mm. The default when shipped is 0 mm. However, the area up to about 5 mm from the leading edge cannot be scanned no matter how you set the scan length.
- We recommend that you specify a slightly larger scan area (5 mm) than is necessary to allow for the scan margin of error.

- Turn Skip Scan permanently on or off with the User Parameters (⇒ P.250), or assign Skip Scan to a User Function key as explained above (⇒ P.225). When shipped, this feature is turned off.

1 Bring up the “Initial Set Up” menu.

Steps **1-4**, ⇒ P.276.

2 Enter the code for “Prog. Scan Area” with the number keys.

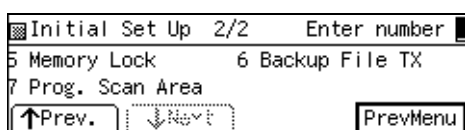

Note

- If the item you require is not shown, press [↑Prev.] or [↓Next] until it is.

3 Enter the skip length with the number keys.

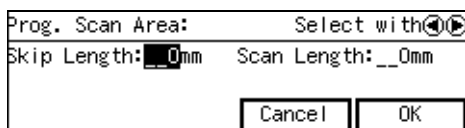

Note

- If you make a mistake, press the [Clear] key and try again.

4 Press the [Right] key to move the cursor to the scan length.

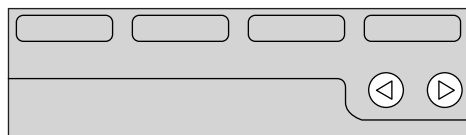
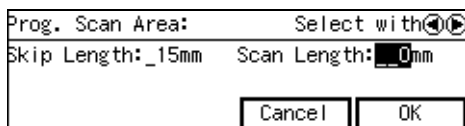

TKSS046N

5 Enter the scan length.

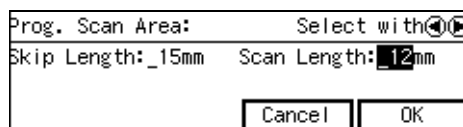

Note

- If you make a mistake, press the [Clear] key and try again.

6 Press [OK].

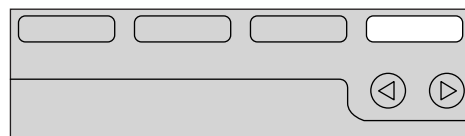
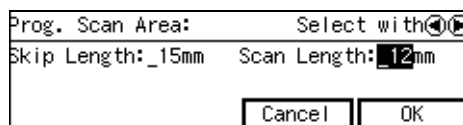

TKSS045N

7 Press [PrevMenu] twice.

8 Press [Exit].

Note

- The standby display reappears.

Box Settings

See the following pages for how to set up and delete Personal Boxes, Information Boxes and Transfer Boxes. This feature provides the following functions:

❖ **Registering/Editing Personal Boxes⇒ P.304**

Registering or editing Personal Boxes

❖ **Deleting Personal Boxes⇒ P.307**

Deleting Personal Boxes

❖ **Registering/Editing Information Boxes⇒ P.309**

Registering or editing Information Boxes

❖ **Deleting Information Boxes⇒ P.311**

Deleting Information Boxes

❖ **Registering/Editing Transfer Boxes⇒ P.312**

Registering or editing Transfer Boxes

❖ **Deleting Transfer Boxes⇒ P.315**

Deleting Transfer Boxes

❖ **Printing the Box List⇒ P.316**

Print this list to view the contents of Personal Boxes, Information Boxes, and Transfer Boxes.

💡 **Limitation**

- ❑ SUB or SEP codes registered in Personal Boxes, Information Boxes or Transfer Boxes cannot be identical.

- ❑ The combined maximum number of Personal Boxes, Information Boxes, and Transfer Boxes that you can store is 150 (400 when the optional Function Upgrade Card is installed).

- ❑ If memory runs out, you may not be able to receive messages or register settings. The available memory capacity depends on installed options.

- ❑ You can edit boxes in the same way as registering them. However, to change the SUB Code itself, you must delete it then register a new SUB Code.

Registering/Editing Personal Boxes

This section describes how to register Personal Boxes.

You can store the following items:

- **SUB Code (required)**
Up to 20 characters long and can be composed of digits 0-9, "#", "*" and spaces (the first character cannot be a space).
- **Name (required)**
Up to 20 characters long.
- **Password (optional)**
Up to 20 characters long and can be composed of digits 0-9, "#", "*" and spaces (the first character cannot be a space).
- **Receiver (optional)**
You can register one delivery destination for each Personal Box. Specify the Quick Dial or Speed Dial that the delivery destination is stored in.

- Quick Dial key (optional)
If you assign this SUB Code to a Quick Dial key, press this key to enter the associated Personal Code (Personal Box SUB Code) with a single key press.

Important

- When using the following functions, you can use SUB codes registered in Personal Boxes in place of Personal Codes.
 - Restricted Access(⇒ P.44)
 - Personal Code Transmission(⇒ P.122)
 - Printing the Journal(⇒ P.156)
 - Searching By Personal Code of TX/RX File Save(⇒ P.160)

Note

- The TTI is not printed on delivered messages.
- If a message cannot be delivered, a Communication Failure Report is printed and the message is saved as a Confidential Reception document.
- You can specify a Quick Dial or Speed Dial containing an e-mail address as the receiver when the optional NIC Fax Kit is installed.
- You can edit boxes in the same way as registering them. However, to change the SUB Code itself, you must delete it then register a new SUB Code.

Reference

P.42 "Personal Boxes"

- 1** Make sure that the machine is in standby mode.

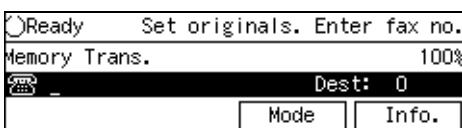

Note

- If the "Fax Features" or "Key Op. Tools" screen is shown, press the [User Tools] key. If any other display is shown, press the [Clear Modes/Energy Saver] key.

- 2** Press the [User Tools] key.

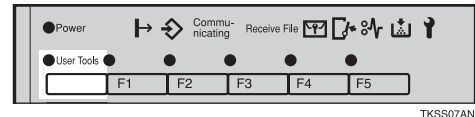

- 3** Enter the code for "Key Op. Tools" with the number keys. Then press the [#] key.

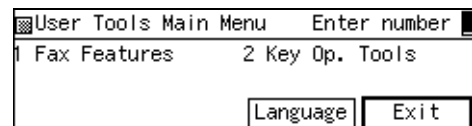

- 4** Enter the code for "Box Settings" with the number keys.

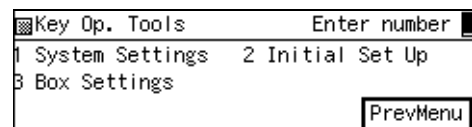

- 5** Enter the code for "Personal Box" with the number keys.

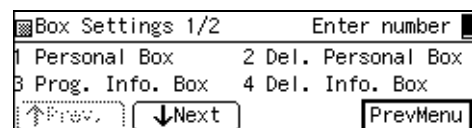

Note

- If the item require is not displayed, press [↑Prev.] or [↓Next] until it is.

6 Enter the SUB Code you wish to register as a Personal Box.

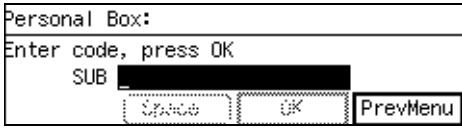

Note

- You can enter up to 20 characters which can be digits 0-9, "#", "*" and spaces (the first character cannot be a space).
- If you make a mistake, press the **[Clear]** key and try again.
- If a password is already stored, enter the password.

7 Press **[OK]**.

8 Press **[Name]**.

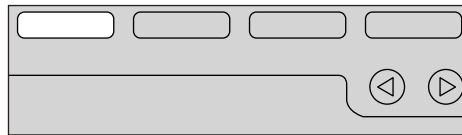

TKSS042N

9 Enter the name of the box.

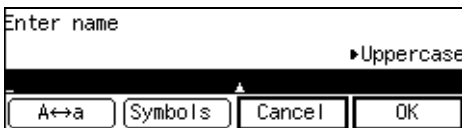

Note

- To change a previously stored name, press the **[Clear]** key then enter a new one.

Reference

P.319 "Entering and Modifying Text"

10 Press **[OK]**.

11 Press **[Others]**.

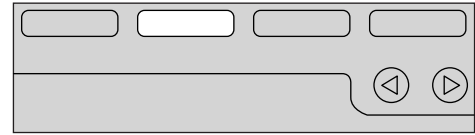
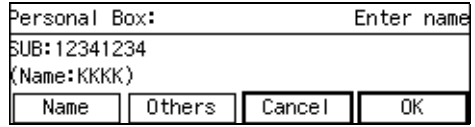

TKSS043N

Registering a Password

1 Enter the code for "Program Password" with the number keys.

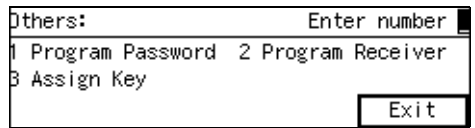

2 Enter the password you wish to store.

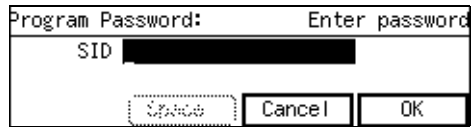

Note

- You can enter up to 20 characters which can be digits 0-9, "#", "*" and spaces (the first character cannot be a space).
- If you make a mistake, press the **[Clear]** key and try again.

3 Press **[OK]**.

Registering a Receiver

- 1 Enter the code for “Program Receiver” with the number keys.

Others:	Enter number
1 Program Password	2 Program Receiver
3 Assign Key	
Exit	

- 2 Specify the Quick Dial or Speed Dial in which the delivery destination is stored.

Program Receiver:
Enter with quick dial/speed dial.
<input type="text"/>
<input type="button" value="Cancel"/> <input type="button" value="OK"/>

- 3 Press [OK].

Assigning a Quick Dial Key

- 1 Enter the code for “Assign Key” with the number keys.

Others:	Enter number
1 Program Password	2 Program Receiver
3 Assign Key	
Exit	

- 2 Press the Quick Dial key you wish to assign the box to.

Assign key:	Press Key To assign
(01-64)	<input type="text"/>
*Press Clear to change	
<input type="button" value="Status"/> <input type="button" value="Cancel"/> <input type="button" value="OK"/>	

Note

- To check the current contents of Quick Dials, press [Status].
- You cannot assign the box to a Quick Dial that is already has programmed with another feature.

- 3 Press [OK].

- 12 Press [Exit].

Others:	Enter number
1 Program Password	2 Program Receiver
3 Assign Key	
Exit	

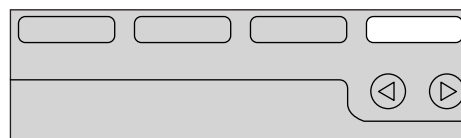

TKSS045N

- 13 [Press] OK.

Personal Box:	Enter name
SUB:12341234	
(Name:KKKK)	
<input type="button" value="Name"/> <input type="button" value="Others"/> <input type="button" value="Cancel"/> <input type="button" value="OK"/>	

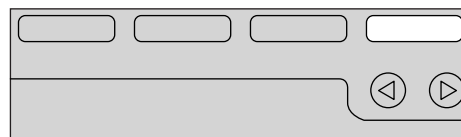

TKSS045N

- 14 Press [PrevMenu] three times.

- 15 Press [Exit] to return to the standby mode.

Deleting Personal Boxes

This section describes how to delete Personal Boxes.

Limitation

- If the specified SUB Code is not registered as a Personal Box, or the messages of the box are registered, you cannot delete it.

- 1 Make sure that the machine is in standby mode.

Ready	Set originals. Enter fax no.
Memory Trans.	100%
Dest: 0	
<input type="button" value="Mode"/> <input type="button" value="Info."/>	

Note

- ❑ If the “Fax Features” or “Key Op. Tools” screen is shown, press the **[User Tools]** key. If any other display is shown, press the **[Clear Modes/Energy Saver]** key.

2 Press the **[User Tools]** key.

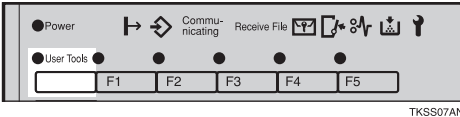

3 Enter the code for “Key Op. Tools” with the number keys. Then press the **[#]** key.

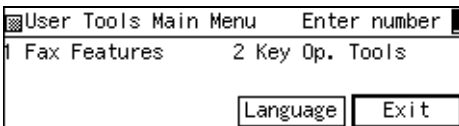

4 Enter the code for “Box Settings” with the number keys.

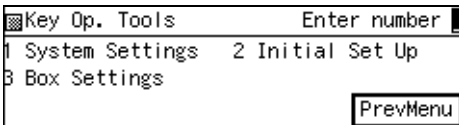

5 Enter the code for “Del. Personal Box” with the number keys.

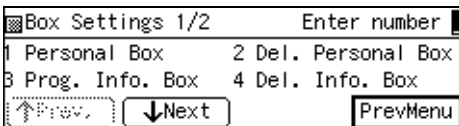

Note

- ❑ If the item you require is not displayed, press **[↑Prev.]** or **[↓Next]** until it is.

6 Enter the SUB Code of the Personal Box you wish to delete.

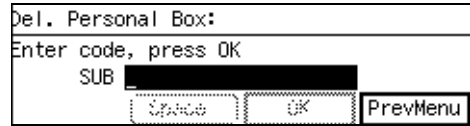

Note

- ❑ You can enter up to 20 characters which can be digits 0-9, "#", "*" and spaces (the first character cannot be a space).
- ❑ If you make a mistake, press the **[Clear]** key and try again.
- ❑ If a password is already stored, enter the password.

7 Press **[OK]**.

8 Press **[Yes]**.

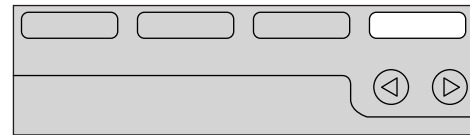
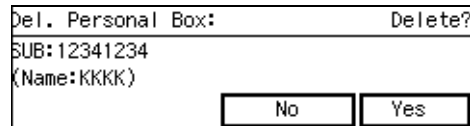

Note

- ❑ If you press **[No]**, the box is not deleted and the display in step **6** reappears.

9 Press **[Yes]**.

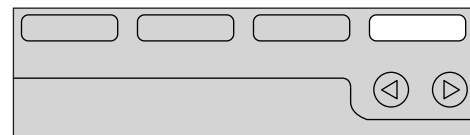
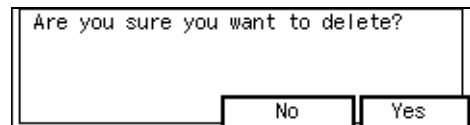

Note

- ❑ If you press [No], the box is not deleted and the display in step 6 reappears.

10 Press [PrevMenu] three times.

11 Press [Exit] to return to the standby mode.

Registering/Editing Information Boxes

This section describes how to set up an Information Box.

You can store the following items:

- SEP Code (required)
Up to 20 characters long and can be composed of digits 0-9, "#", "*" and spaces (the first character cannot be a space).
- Password (optional)
Up to 20 characters long and can be composed of digits 0-9, "#", "*" and spaces (the first character cannot be a space).
- Name (required)
Up to 20 characters long.

Note

- ❑ You can edit boxes in the same way as registering them. However, to change the SEP Code itself, you must delete it then register a new SEP Code.

Reference

P.43 "Information Boxes"

1 Make sure that the machine is in standby mode.

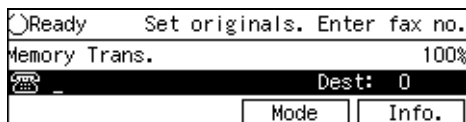
**Note**

- ❑ If the "Fax Features" or "Key Op. Tools" screen is shown, press the [User Tools] key. If any other display is shown, press the [Clear Modes/Energy Saver] key.

2 Press the [User Tools] key.

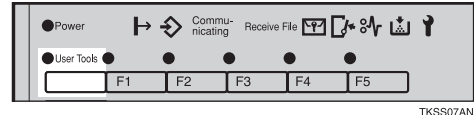

3 Enter the code for "Key Op. Tools" with the number keys. Then press the [#] key.

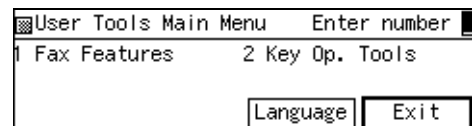

4 Enter the code for "Box Settings" with the number keys.

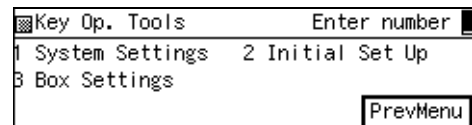

5 Enter the code for "Prog. Infor. Box" with the number keys.

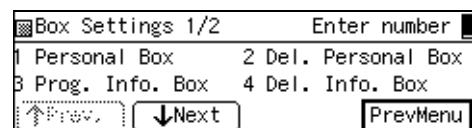
**Note**

- ❑ If the item require is not displayed, press [↑Prev.] or [↓Next] until it is.

6 Enter the SEP code you wish to register as an Information Box.

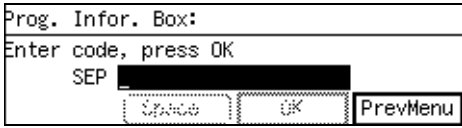

Note

- You can enter up to 20 characters which can be digits 0-9, "#", "*" and spaces (the first character cannot be a space).
- If you make a mistake, press the **[Clear]** key and try again.
- If a password is already stored, enter the password.

7 Press **[OK]**.

8 Press **[Name]**.

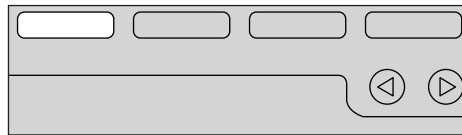
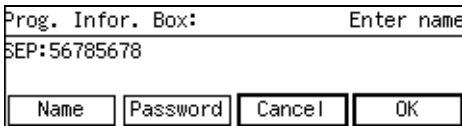

TKSS042N

9 Enter the name of the box.

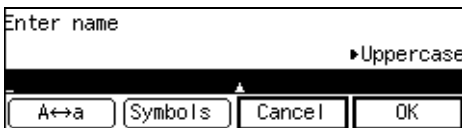

Note

- To change a previously stored name, press the **[Clear]** key then enter a new one.

Reference

P.319 "Entering and Modifying Text"

10 Press **[OK]**.

11 Press **[Password]**.

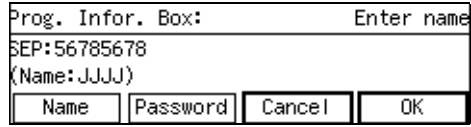

TKSS043N

Note

- If you do not wish to register a password, go to step **14**.

12 Enter the password you wish to store.

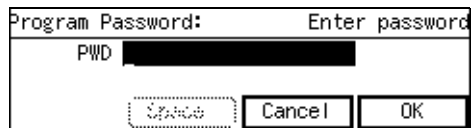

Note

- You can enter up to 20 characters which can be digits 0-9, "#", "*" and spaces (the first character cannot be a space).
- If you make a mistake, press the **[Clear]** key and try again.

13 Press **[OK]**.

14 Press **[OK]**.

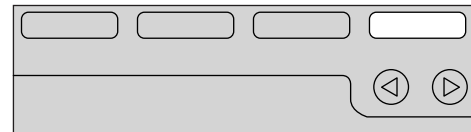
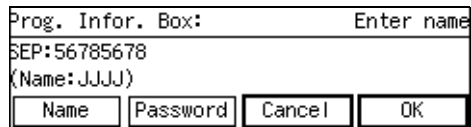

TKSS045N

15 Press **[PrevMenu]** three times.

16 Press **[Exit]** to return to the stand-by mode.

Deleting Information Boxes

This section describes how to delete Information Boxes.

! Limitation

- If the specified SEP Code is not registered as an Information Box or the messages of the box are registered, you cannot delete it.

- 1** Make sure that the machine is in standby mode.

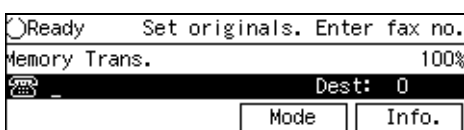

✎ Note

- If the “Fax Features” or “Key Op. Tools” screen is shown, press the **[User Tools]** key. If any other display is shown, press the **[Clear Modes/Energy Saver]** key.

- 2** Press the **[User Tools]** key.

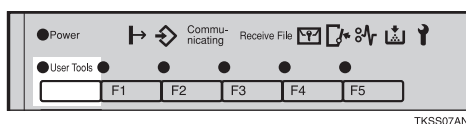

TKSS07AN

- 3** Enter the code for “Key Op. Tools” with the number keys. Then press the **[#]** key.

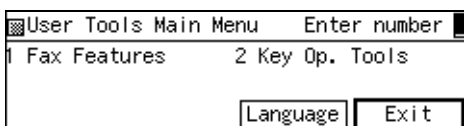

- 4** Enter the code for “Box Settings” with the number keys.

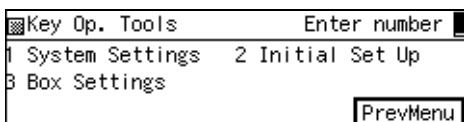

- 5** Enter the code for “Del. Infor. Box” with the number keys.

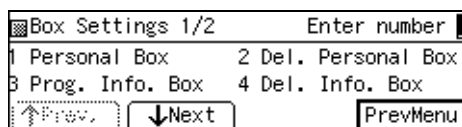

✎ Note

- If the item require is not displayed, press **[↑Prev.]** or **[↓Next]** until it is.

- 6** Enter the SEP Code of the Information box you wish to delete.

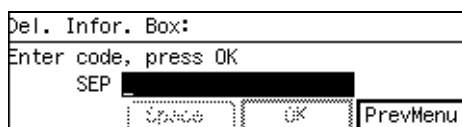

✎ Note

- You can enter up to 20 characters which can be digits 0-9, “#”, “*” and spaces (the first character cannot be a space).
- If you make a mistake, press the **[Clear]** key and try again.
- If a password is already stored, enter the password.

- 7** Press **[OK]**.

- 8** Press **[Yes]**.

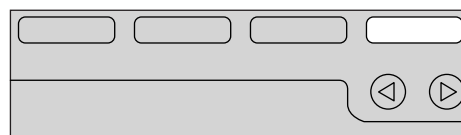
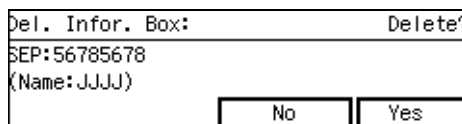

TKSS045N

✎ Note

- If you press **[No]**, the box is not deleted and the display in step **6** reappears.

9 Press [Yes].

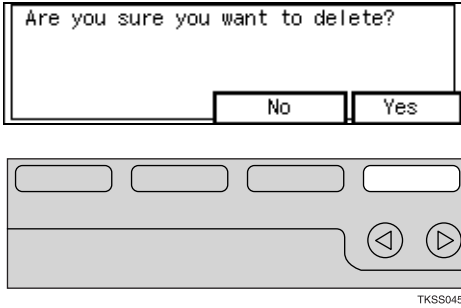

Note

- If you press [No], the box is not deleted and the display in step 6 reappears.

10 Press [PrevMenu] three times.

11 Press [Exit] to return to the stand-by mode.

Registering/Editing Transfer Boxes

This section describes how to set up a Transfer Box for forwarding incoming SUB transfer request messages onto end receivers.

You can store the following items:

- SUB (required)
Up to 20 characters long and can be composed of digits 0-9, "#", "*" and spaces (the first character cannot be a space).
- Name (required)
Up to 20 characters long.
- SID (optional)
Up to 20 characters long and can be composed of digits 0-9, "#", "*" and spaces (the first character cannot be a space).
- End Receiver (required)

You can store 5 end receivers (destinations to which messages will be forwarded) for each box. Specify end receivers with Quick Dials, Speed Dials, or Groups assigned to Quick Dials that have been registered beforehand.

Limitation

- After messages are transferred, a Transfer Result Report is not sent back to the sender.

Note

- After messages are transferred they are deleted.
- By default, the machine prints out received messages and the Transfer Result Report that it transfers after the transfer has finished. If you want to turn this feature off, please contact your service representative.
- You can have received messages sent using Economy Transmission. Please contact your service representative for details.
- When the registered receiver is a Multi-step Transfer Group Dial, Multi-step Transfer takes place.
- You can specify a Quick Dial or Speed Dial containing an e-mail address as the receiver when the optional NIC Fax Kit is installed.
- You can edit boxes in the same way as registering them. However, to change the SUB Code itself, you must delete it then register a new SUB Code.

Reference

P.43 "Transfer Boxes"

- 1 Make sure that the machine is in standby mode.

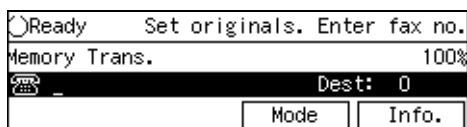

Note

- If the “Fax Features” or “Key Op. Tools” screen is shown, press the [User Tools] key. If any other display is shown, press the [Clear Modes/Energy Saver] key.

- 2 Press the [User Tools] key.

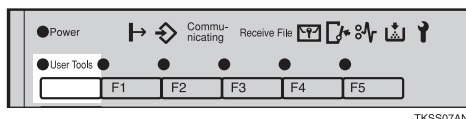

TKSS07AN

- 3 Enter the code for “Key Op. Tools” with the number keys. Then press the [#] key.

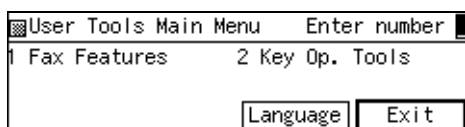

- 4 Enter the code for “Box Settings” with the number keys.

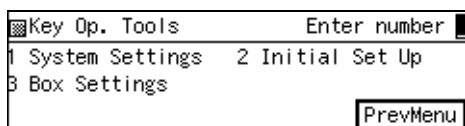

- 5 Enter the code for “Prog. Transf. Box” with the number keys.

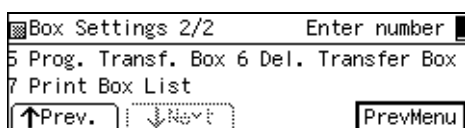

Note

- If the item require is not displayed, press [↑Prev.] or [↓Next] until it is.

- 6 Enter the SUB code you wish to register as a Transfer Box.

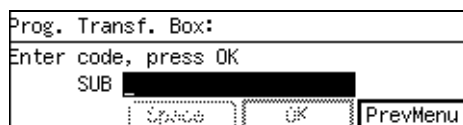

Note

- You can enter up to 20 characters which can be digits 0-9, "#", "*" and spaces (the first character cannot be a space).
- If you make a mistake, press the [Clear] key and try again.
- If a password is already stored, enter the password.

- 7 Press [OK].

- 8 Press [Name].

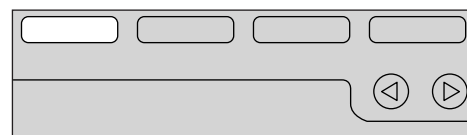

TKSS042N

- 9 Enter the name for the Transfer Box.

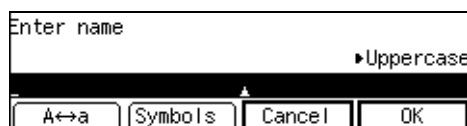

Note

- To change a previously stored name, press the [Clear] key then enter a new one.

Reference

P.319 "Entering and Modifying Text"

10 Press [OK].

11 Press [Others].

TKSS043N

Registering a Password (SID)

1 Enter the code for "Program Password" with the number keys.

2 Enter the password you wish to store.

Note

- You can enter up to 20 characters which can be digits 0-9, "#", "*" and spaces (the first character cannot be a space).
- If you make a mistake, press the [Clear] key and try again.

3 Press [OK].

Registering End Receivers

1 Enter the code for "Prog. Receiver" with the number keys.

2 Enter the number of the end receiver you wish to register with the number keys.

Note

- You can register up to 5 end receivers.

3 Specify the Quick Dial, Speed Dial or Group in which the end receiver is stored.

4 Press [OK].

5 Press [PrevMenu].

12 Press [Exit].

TKSS045N

- 13** Press [OK].

Prog. Transf. Box:		Enter name	
SUB: 8888			
(Name: PPPP)			
Name	Others	Cancel	OK

			⏪ ⏩

TKSS045N

- 14** Press [PrevMenu] three times.

- 15** Press [Exit] to return to the standby mode.

Deleting Transfer Boxes

This section describes how to delete Transfer Boxes.

! Limitation

- ❑ If the specified SUB Code is not registered as a Transfer Box, or the messages of the box are registered you cannot delete it.

- 1** Make sure that the machine is in standby mode.

Ready	Set originals. Enter fax no.
Memory Trans.	100%
Dest: 0	
Mode	Info.

📎 Note

- ❑ If the “Fax Features” or “Key Op. Tools” screen is shown, press the [User Tools] key. If any other display is shown, press the [Clear Modes/Energy Saver] key.

- 2** Press the [User Tools] key.

Power	Communicating	Receive File			
User Tools					
F1	F2	F3	F4	F5	

TKSS07AN

- 3** Enter the code for “Key Op. Tools” with the number keys. Then press the [#] key.

User Tools Main Menu		Enter number	
1 Fax Features	2 Key Op. Tools		
		Language	Exit

- 4** Enter the code for “Box Settings” with the number keys.

Key Op. Tools		Enter number	
1 System Settings	2 Initial Set Up		
3 Box Settings			
			PrevMenu

- 5** Enter the code for “Del. Transfer Box” with the number keys.

Box Settings 2/2		Enter number	
5 Prog. Transf. Box	6 Del. Transfer Box		
7 Print Box List			
↑Prev.	↓Next	PrevMenu	

📎 Note

- ❑ If the item require is not displayed, press [↑Prev.] or [↓Next] until it is.

- 6** Enter the SUB code of the Transfer Box you wish to delete.

Del. Transfer Box:		
Enter code, press OK		
SUB		
Space	OK	PrevMenu

📎 Note

- ❑ You can enter up to 20 characters which can be digits 0-9, “#”, “*” and spaces (the first character cannot be a space).

- If you make a mistake, press the **[Clear]** key and try again.
- If a password is already stored, enter the password.

7 Press **[OK]**.

8 Press **[Yes]**.

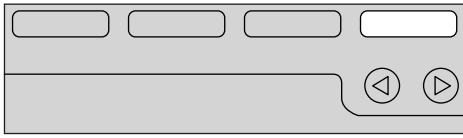
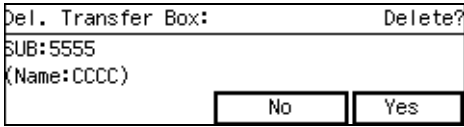

TKSS045N

Note

- If you press **[No]**, the box is not deleted and the display in step **6** reappears.

9 Press **[Yes]**.

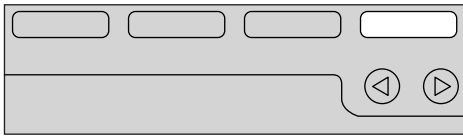
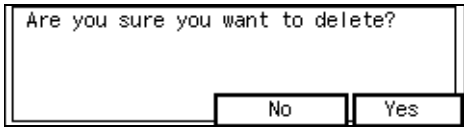

TKSS045N

Note

- If you press **[No]**, the box is not deleted and the display in step **6** reappears.

10 Press **[PrevMenu]** three times.

11 Press **[Exit]** to return to the standby mode.

Printing the Box List

Follow the procedure below to print a list showing the currently registered Personal Boxes, Information Boxes and Transfer Boxes.

1 Make sure that the machine is in standby mode.

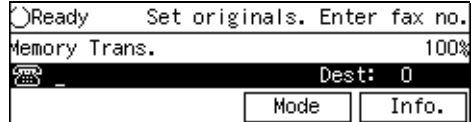

Note

- If the “Fax Features” or “Key Op. Tools” screen is shown, press the **[User Tools]** key. If any other display is shown, press the **[Clear Modes/Energy Saver]** key.

2 Press the **[User Tools]** key.

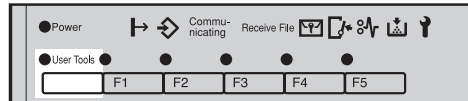

TKSS07AN

3 Enter the code for “Key Op. Tools” with the number keys. Then press the **[#]** key.

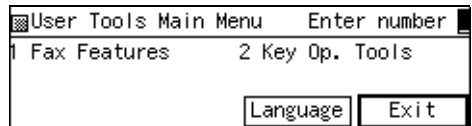

4 Enter the code for “Box Settings” with the number keys.

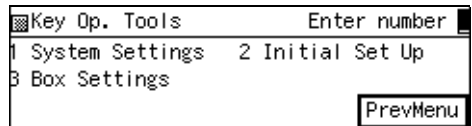

- 5** Enter the code for “Print Box List” with the number keys.

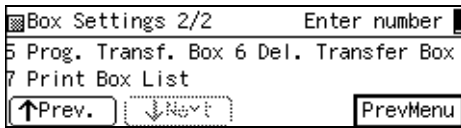

 **Note**

- If the item require is not displayed, press [↑Prev.] or [↓Next] until it is.

- 6** Press the **[Start]** key.

The list is printed.

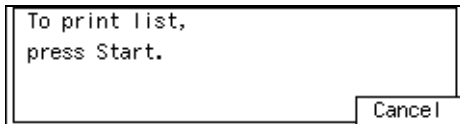

 **Note**

- To cancel printing, press **[Cancel]**. The display in step **5** will reappear.

- 7** Press **[PrevMenu]** twice.

- 8** Press **[Exit]** to return to the stand-by mode.

10. Entering and Modifying Text

Available Characters

This section describes how to enter characters. When you enter a character, it is inserted at the cursor position.

- **Alphabetic characters**
ABCDEFGHIJKLMNQRSTU-
VWXYZabcdefghijklmnopqrstuvwxyz
- **Symbols**
- **Numbers**
0123456789

Keys

- ❖ **Number keys**
Use to enter numbers.
- ❖ **Quick Dial 01/33 to Quick Dial 32/64 (A to Z)**
Press these keys to enter upper and lower case letters.
- ❖ **[A↔a] key**
Use to switch between upper and lower case.
- ❖ **Quick Dial 27/59**
Press to enter a space.
- ❖ **[Clear] key**
Deletes a character at the cursor position. You can delete a character at the right end of a line even if the cursor is placed to the right of the character.
- ❖ **⏪ and ⏩**
Use to move the cursor left or right.

 **Note**

- If you wish to enter symbols, press the **[Symbols]** key.

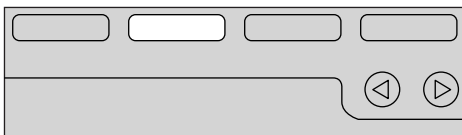
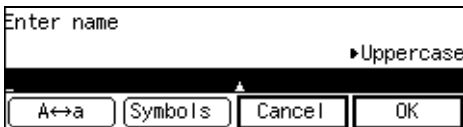

TKSS043N

- Flip up the Quick Dial flip plate to access the character keys you need.
- Quick Dial 01/33 means Quick Dial key 01 or 33.

 **Wildcards**

If you wish to register multiple RTIs or CSIs, you can register a sequence of characters common to these identifications as a wildcard instead of registering every identification.

If the destination has an RTI or CSI containing a wildcard, the machine determines that the destination matches the registered destination.

❖ **Not using a Wildcard**

Destination to be registered (RTI)	Number of registered identifications
NEW YORK BRANCH	3
HONG KONG BRANCH	
SYDNEY BRANCH	

❖ **Using a Wildcard**

Destination to be registered (RTI)	Number of registered identifications
BRANCH	1

 **Limitation**

- You can register up to 30 wildcards.

 **Note**

- Identifications are compared ignoring spaces.
- You can use wildcards for the following functions:
 - “Collate” ⇒ P.276
 - “Authorized Reception” ⇒ P.278

-
- *"Specified Tray"* ⇒ P.281
 - *"Forwarding"* ⇒ P.284
 - *"Memory Lock"* ⇒ P.292
 - *"TX/RX File In HD"* ⇒ P.295
-

How To Enter Text

Entering Letters

1 Press [A↔a] to switch between uppercase and lowercase character input.

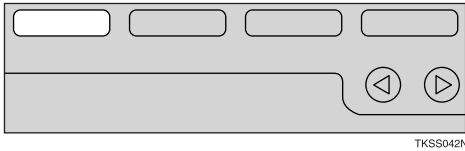
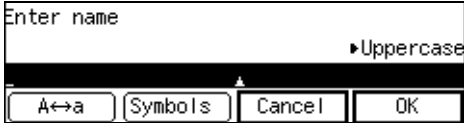

TKSS042N

2 Press a Quick Dial key. A letter is entered and the cursor moves.

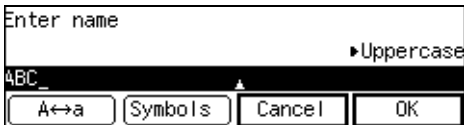

Note
 If you wish to you enter another character, repeat step **2**.

Entering Symbols

1 Press [Symbols].

The available symbols are shown on the display.



TKSS043N

2 Select the desired symbol by pressing [↑Prev.] and [↓Next].

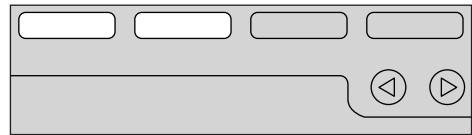
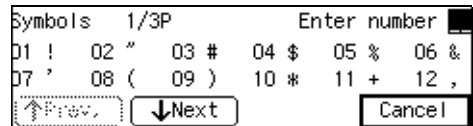

TKSS044N

3 Enter the code of the symbol you wish to enter with the number keys.

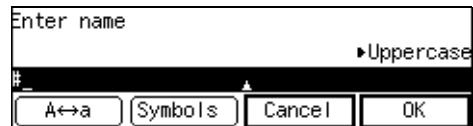

The symbol is entered and the cursor moves.

Note
 If you wish to you enter another symbol, repeat steps **1** to **3**.

Entering Numbers

1 Press a number key.

The number is entered and the cursor moves.

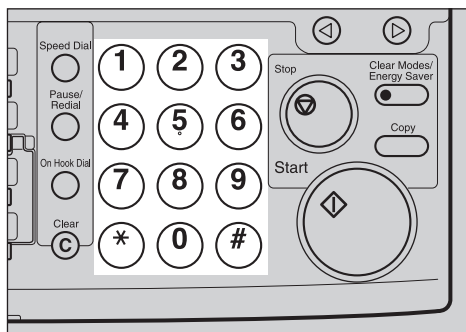

TKSS025E

Deleting Characters

- 1 Press the ⏪ and ⏩ keys to move the cursor to a character you want to delete.

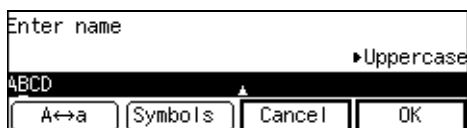

- 2 Press the [Clear] key.

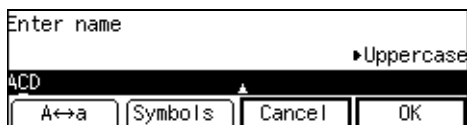

The character at the cursor position is deleted.

Note

- If you wish to delete another character, repeat steps 1 and 2.

11. Maintaining Your Machine

Maintaining the Machine

If the parts mentioned below get dirty, prints and copies may not come out clearly. To ensure your machine continues to produce the highest quality printed output, we recommend that you clean these parts periodically.

Important

- ❑ Do not use thinner, benzene, or alcohol based cleaning solutions. Doing so may cause plastic parts to become malformed or discolored.

This section describes how to clean the following parts:

- Document Transport Mechanism
- Copy Paper Transport Mechanism

Cleaning the Document Transport Mechanism

- 1** Open the ADF cover in the direction of the arrow.

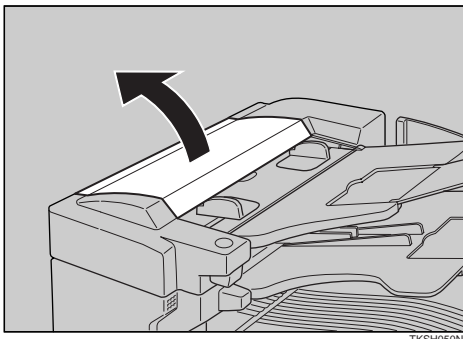

- 2** Remove the feed unit.

Push it the direction of the arrow **1** then pull it towards you to remove it **2**.

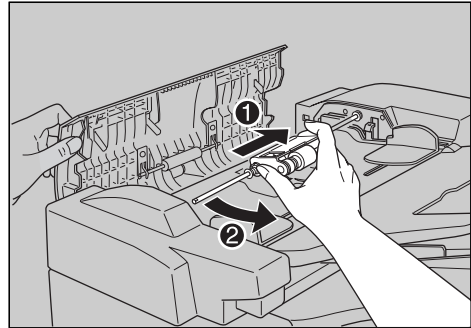

- 3** Rotate and wipe the separation roller to make sure the entire surface is clean.

Use a soft cloth that has been dampened with water and wrung out.

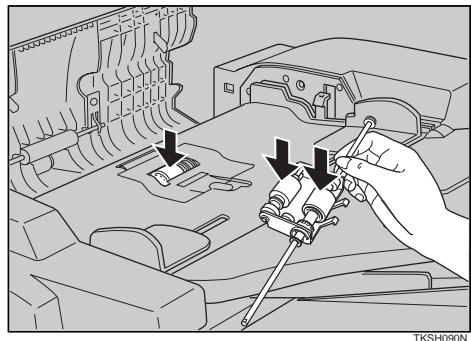

- 4** Return the feed unit to its original position as shown.

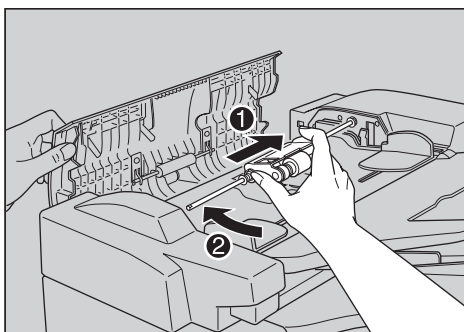

TKSM120N

5 Close the ADF cover making sure it clicks firmly into place.

6 While pushing the release lever, open the ADF unit as shown.

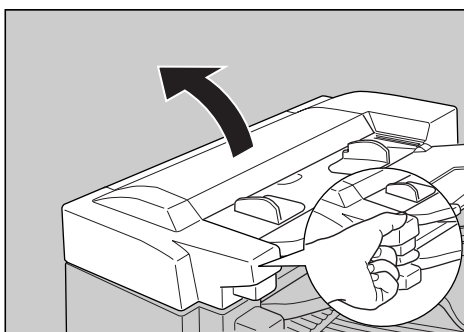

TKSG080N

7 Wipe the exposure glass, the white strip under the platen cover, and the six rollers.

Use a dry, soft cloth. If it is really dirty, wipe with a soft cloth that has been dampened with water and wrung out, then wipe the surface with a dry cloth.

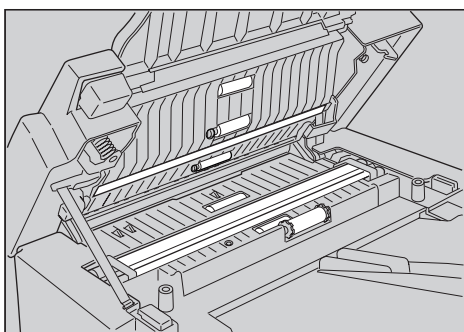

TKSH070N

8 Close the ADF unit making sure it clicks firmly into place.

Cleaning the Copy Paper Transport Mechanism

Main Paper Cassette

1 Open the main paper cassette side cover as shown.

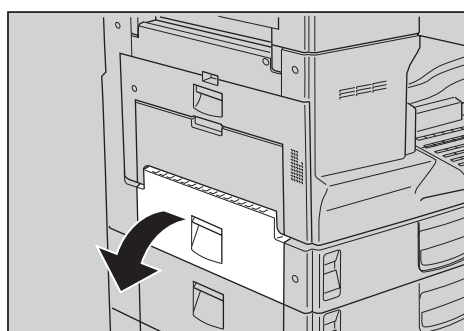

TKSY360N

2 Wipe the two rollers with a soft cloth that has been dampened with water and wrung out.

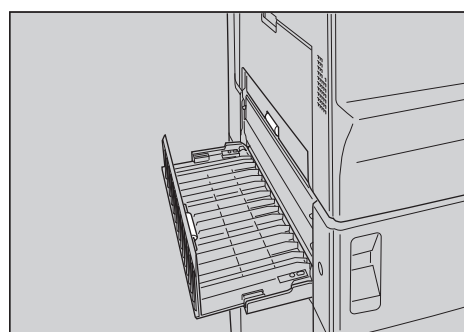

TKSH080N

3 Close the main paper cassette side cover making sure it locks firmly into place.

Optional Paper Supply Unit

- 1 Open the paper supply unit side cover as shown.

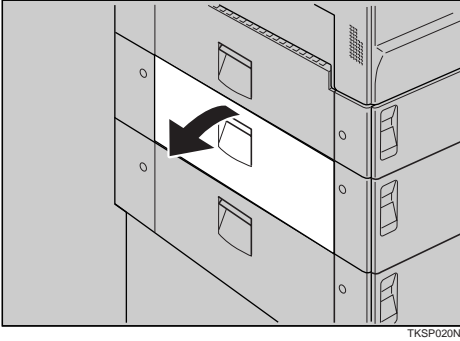

- 2 Wipe the five rollers with a soft cloth that has been dampened with water and wrung out.

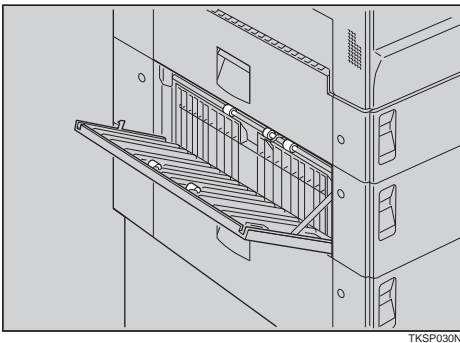

- 3 Close the paper supply side cover making sure it locks firmly into place.

Cleaning the Registration Roller

Always turn the main power switch off before cleaning the registration roller. Attempting to clean this roller with the power on could result in a burn injury.

- 1 Open the main side cover as shown.

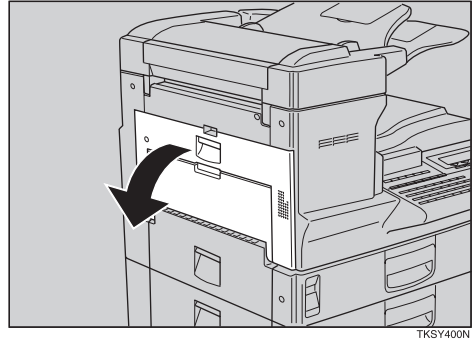

- 2 While rotating the rubber part of the registration roller, wipe it a soft cloth that has been dampened with water and wrung out.

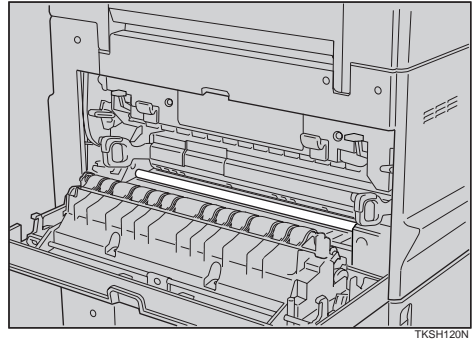

- 3 Close the main side cover making sure it locks firmly into place.

Maintenance Kits

Some parts require periodic replacement to ensure the machine is kept in peak condition. When the “Limit reached: replace the ADF Roller and clear the counter.” or “Limit reached: replace the Fusing Unit and the Transfer Roller and clear the counter.” message is displayed, be sure to follow the appropriate procedure below to replace all the relevant components.

There are two maintenance kits:

- ADF Maintenance Kit —a replacement ADF feed unit and separation corona
- Fusing Unit Maintenance Kit —a replacement fusing unit and transfer roller

Installing the ADF Unit Maintenance Kit

Follow these steps to install the Fusing Unit Maintenance Kit when “Limit reached: replace the ADF Roller and clear the counter.” is displayed. Only remove the separation corona when installing the maintenance kit.

- 1** Open the ADF cover in the direction shown.

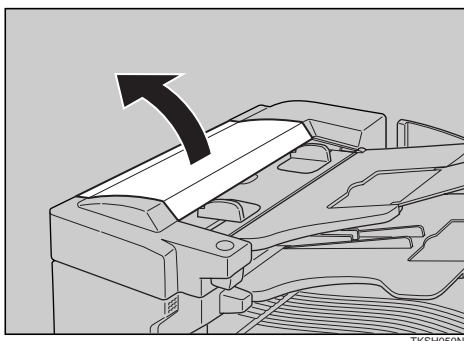

- 2** Push in the feed unit as shown, then grasp the front part and pull it out.

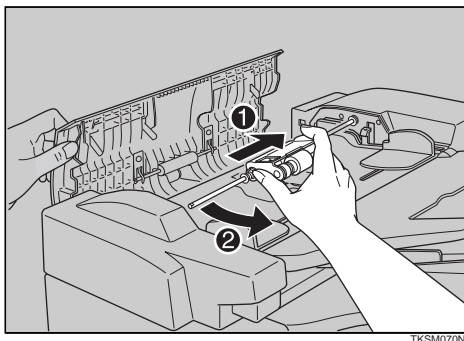

- 3** Rotate the separation corona stopper (green) to the right then remove the cover.

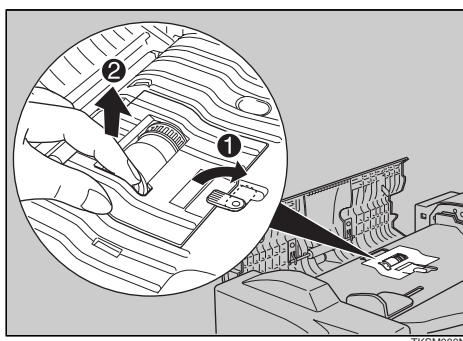

- 4** While pressing down on the white case of the separation corona, pull up the green knob. Then remove the separation corona.

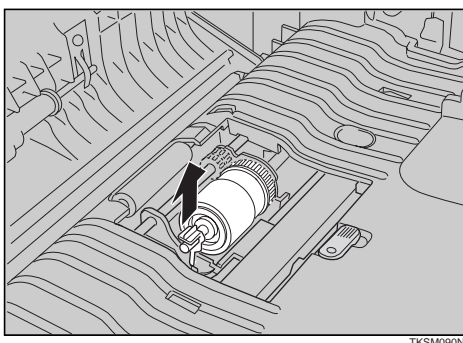

- 5** Install the new separation corona as shown.

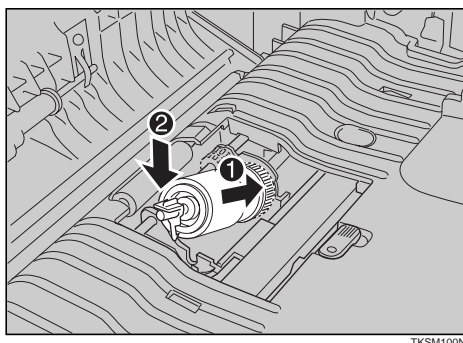

- 6** Replace the cover as shown.

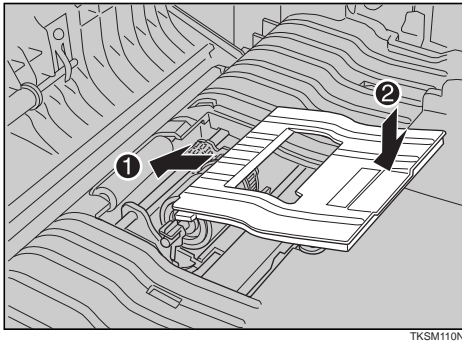

TKSM110N

- 7** Rotate the separation corona stopper (green) to the left to secure the cover.

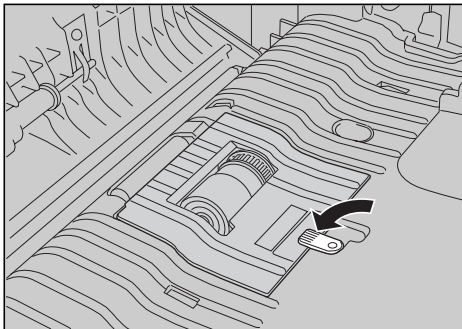

TKSM110N

- 8** Remove the red holder of the new feed unit.

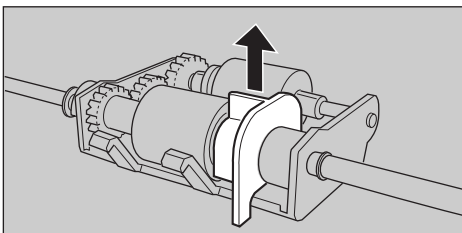

TKSM131N

- 9** Push in the new feed unit as shown.

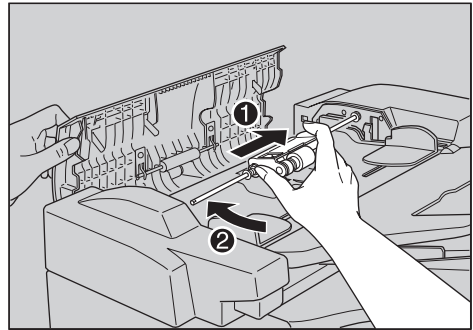

TKSM120N

- 10** Close the ADF cover making sure it clicks firmly into place.

- 11** Clear the "PM Counter".

Reference

P.271 "Reset PM Counters"

Installing the Fusing Unit Maintenance Kit

Follow these steps to install the Fusing Unit Maintenance Kit when "Limit reached: replace the Fusing Unit and the Transfer Roller and clear the counter." is displayed.

Important

- Always make sure the free memory is 100% and turn the main power switch off before pulling out the fixing unit. If the power is on when you pull it out, the machine will be damaged.

Limitation

- Only pull out the fusing unit when replacing it.

- 1 Open the main side cover as shown.

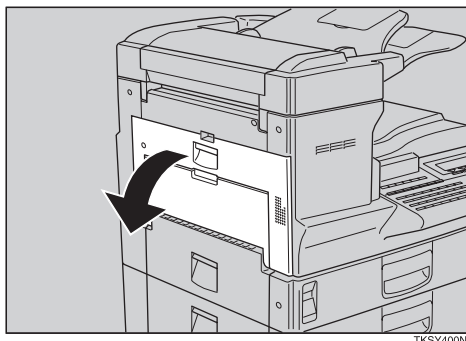

- 3 Grasp the left and right fusing unit handles and lift out the unit towards you.

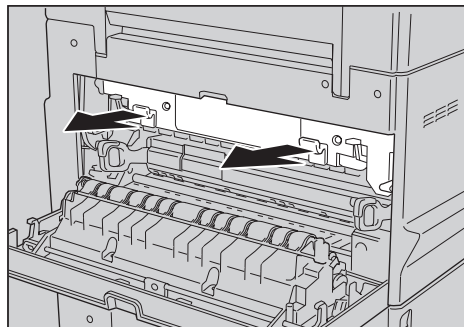

Replacing the Fusing Unit

- 1 Remove the screw located under the fusing unit fixed lever (brown).

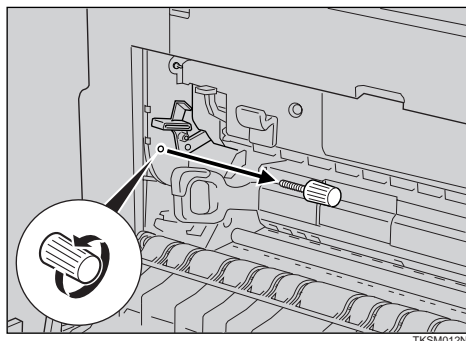

- 4 Push the new fusing unit into the machine making sure it slides along the fixing unit lever guides.

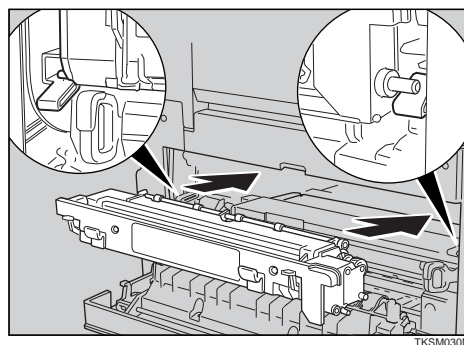

- 2 Lower the left and right fusing unit levers (brown) in the direction shown.

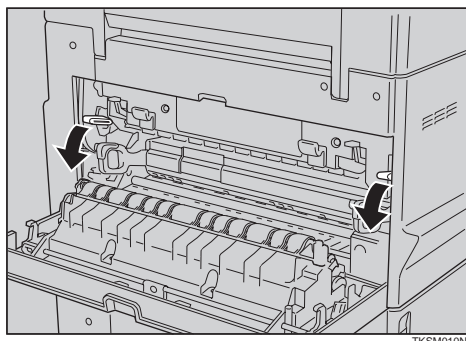

- 5 Push up the left and right fusing unit levers (brown) as shown.

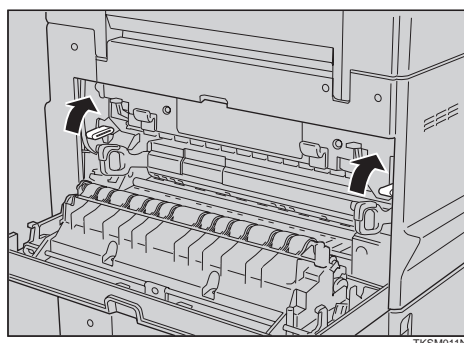

- ⑥ Replace the screw you removed in step ①.

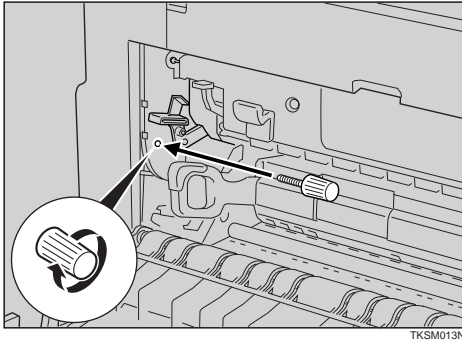

Replacing the Transfer Roller

- ① Open the transfer roller cover upwards.

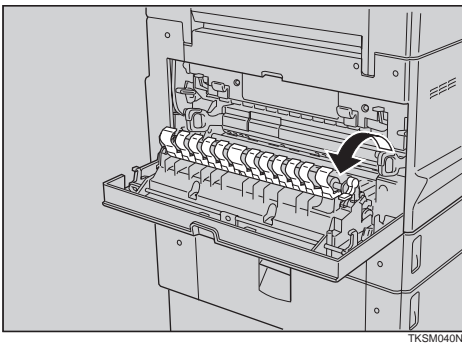

- ② Put on the two gloves packed with the new maintenance kit to prevent getting your hands dirty (the old transfer roller will be covered in toner).

- ③ Hold both ends (green) of the old transfer roller and lift it out.

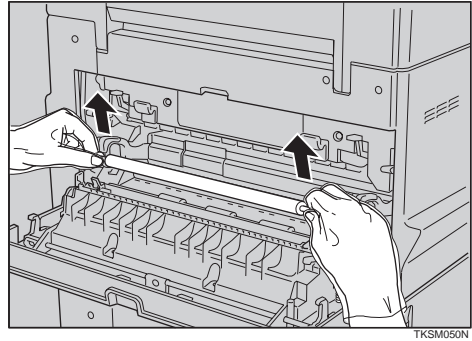

- ④ Hold both ends (green) of the new transfer roller making sure the gear area is on the left, then push it in until it firmly clicks into place.

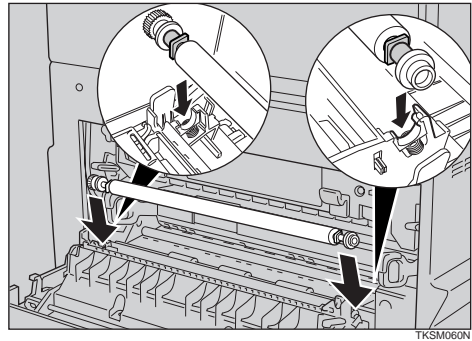

- ② Firmly close the main side cover.

- ③ Clear the "PM Counter".

 Reference

P.271 "Reset PM Counters"

Replacing the Stamp Cartridge

When the stamp mark begins to fade, it is time to install a new stamp cartridge.

 Note

- ❑ Only use stamp cartridges designed specifically for this machine.

- 1** While pushing the release lever, open the ADF unit as shown.

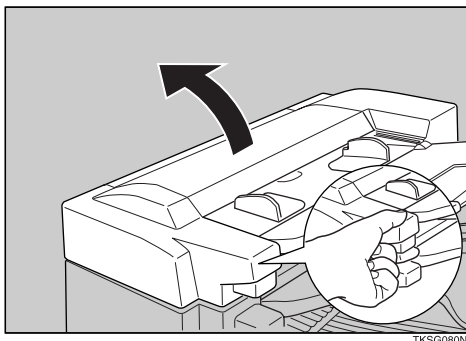

- 3** While supporting the ADF unit, insert the new stamp cartridge.

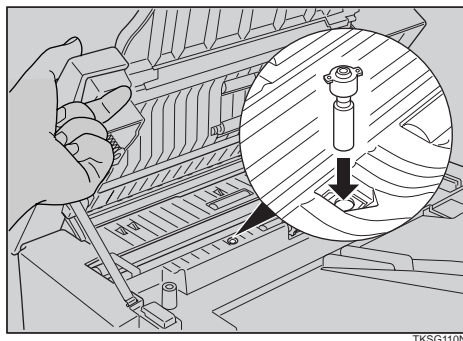

- 2** While supporting the ADF unit, pull out the old stamp cartridge.

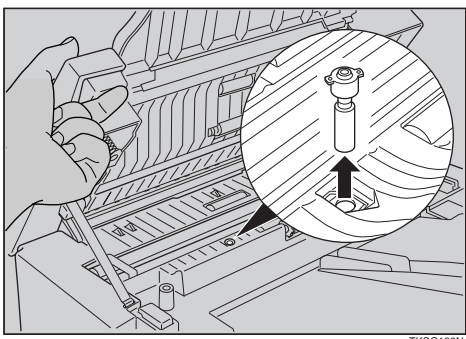

- 4** Close the ADF unit making sure it clicks firmly into place.

 **Note**

- Remove the stamp cartridge with pincers, or carefully ease out the end of the stamp head with your fingernails.

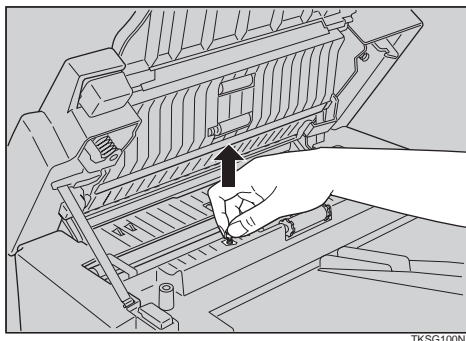

Options

Memory Cards

You can increase memory capacity by installing one of the following feature expanders:

- ❖ **Optional 2M Expanded Memory Card**
+2MB, total 4MB, 320 pages
- ❖ **Optional 4M Expanded Memory Card**
+4MB, total 6MB, 480 pages
- ❖ **Optional 40M Expanded Memory Card**
To be able to expand to 40MB, 3,000 pages

 **Note**

- Figures are measured using a ITU-T#1 chart (Slerexe letter) at standard resolution.
- If you would like to install optional 40M Expanded Memory Card, please contact your service representative.

Optional Function Upgrade Card

Installing this option expands the capacity of various functions and furnishes your machine with even more advanced features. The following table summarizes.

Function	Without Function Upgrade Card	With Function Upgrade Card
Boxes	150	400
Group Dials	9	30
Memory Capacity for Memory Transmission	250 Sheet	1000 sheet
Memory Transmission Files	1200	3000
Auto Documents	64	164
Keystroke Programs	64	164
Communication Result Log	last 256 communication	last 1000 communication
Speed Dials	100	1000

Function	Without Function Upgrade Card	With Function Upgrade Card
Wildcards	30	50
Skip Transmission	Not available	Available
TX/RX File In HD	Not available	Available (require the optional 40 M Expanded Memory Card)

Limitation

- The optional Function Upgrade Card cannot be installed in conjunction with the optional Fax On Demand card.

Optional Fax On Demand

When the Fax On Demand is installed, your machine becomes capable of providing a sophisticated fax information service. Optional Fax On Demand comprises the Fax On Demand card and a microphone.

Limitation

- The Fax On Demand card cannot be installed in conjunction with the optional Function Upgrade Card, and neither is it possible to switch these cards over whenever you wish to use the other.

Installing the Memory Cards, Optional Function Upgrade Card and Fax On Demand Card

Important

- Always turn the power switch off before installing or removing cards or they could be damaged.
- Always make sure that the free memory is 100% before turning the power switch off. Installing cards when free memory is less than 100% will result in the memory contents being completely erased.
- Once you have installed the optional Function Upgrade Card or Fax on Demand card, do not remove it or the settings you have stored for this card will be completely erased.

Limitation

- If you would like to install optional 40M Expanded Memory Card, please contact your service representative.

1 Make sure that the free memory is 100%, then switch off the power switch.

- 2** Remove the protective cover from the slot.

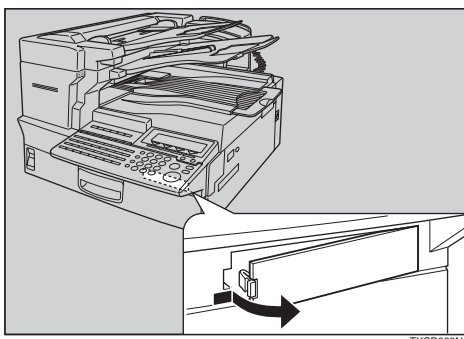

- 3** Insert the card into the appropriate slot with the side printed with the product name face-up.

Right slot: Only for memory cards.

Left slot: Optional Function Upgrade Card or Fax on Demand card.

Important

- If the card is in the wrong slot, it will not work.

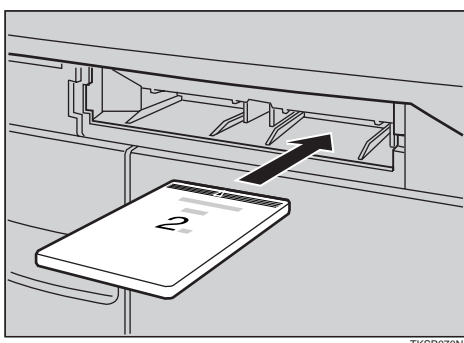

- 4** Replace the protective cover.

Optional G3 Unit

Provides an extra G3 line port in addition to the standard G3 line.

Limitation

- This option and the optional G4 Unit cannot be installed at the same time.

Optional G4 Unit

Provides the capability to connect to the ISDN. The sub-address function becomes available when this option is installed.

Limitation

- Optional G4 Unit cannot be installed in conjunction with the optional G3 Unit.

Connecting the Machine to the ISDN

If you have the ISDN option, connect the machine to the ISDN using a modular type connector.

Important

- Before connecting the machine to the ISDN, please contact your service representative.

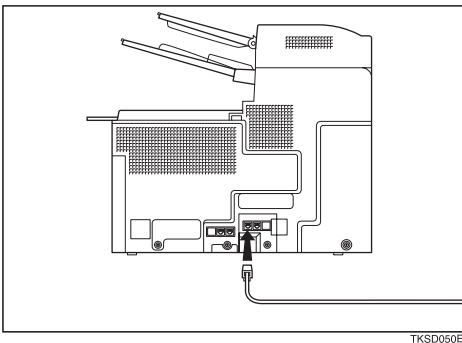

Optional NIC FAX Kit

Enables transmission and reception of fax documents via e-mail between this machines, and transmission of e-mail to personal computers.

If you connect the NIC FAX to a LAN e-mail environment, faxes can be sent over the Internet using e-mail. Transmission and reception is possible between this machines and other devices that support TIFF-F encoding, and transmission to PC's is also possible.

Limitation

- Cannot be installed in conjunction with the optional PC-FAX Expander.

Reference

Please refer to the optional NIC FAX Kit Manual for details.

Optional PC-FAX Expander

Allows you to connect a personal computer to the machine and fax documents directly from your PC desktop.

Reference

For details, please refer to the optional PC-FAX Expander manual.

Optional Printer Interface

Enables the machine to be connected to a personal computer and used as a printer. Furthermore, if you also install the optional Network Interface Board, the machine can be connected to a LAN environment and used as a network printer.

Reference

For details, please refer to the optional Printer Interface manual.

Other Options

❖ Optional JBIG Unit

Enables the machine to use the JBIG (Joint Bi-level Image experts Group) high compression method. Even when you scan in documents at Photo resolution, they are sent quickly. This feature can be used with G3, I-G3 and G4 lines.

Limitation

- If the other party's machine does not have the JBIG Reception and ECM function, this feature cannot be used.

❖ Optional Paper Supply Unit

Enables up to 500 sheets of paper to be loaded at a time. Up to two of these units can be installed.

Function List

Advanced Transmission Features

Feature name	Description	Reference
Send Later	Sets the machine to automatically start transmission or Polling Reception at the appointed time.	P.118 <i>"Send Later"</i>
Confidential Transmission	Sends a confidential message. This feature is divided into Default ID Confidential Transmission and Override ID Confidential Transmission.	P.120 <i>"Confidential Transmission"</i>
Personal Code Transmission	This will help you to check up on who has been using the machine and how often.	P.122 <i>"Personal Code Transmission"</i>
SUB Code Transmission	You can send and receive confidential faxes to and from other maker's machines that have the SUB/SID feature.	P.125 <i>"SUB Code Transmission with the Mode Key"</i>
SEP Code Polling Reception	If you wish receive a message stored in the memory of another party's fax machine, you can use this feature.	P.128 <i>"SEP Code Polling Reception"</i>
Polling Reception	Sends a transmission request to the other party and receives a message from the receiver. This feature is divided into Default ID Polling Reception and ID Override Polling Reception.	P.131 <i>"Polling Reception"</i>

Feature name	Description	Reference
Polling Transmission	Upon request from a destination, the machine sends a document stored in memory. This feature is divided into Free Polling, Default ID Polling Transmission, and Override ID Polling Transmission.	P.134 <i>"Polling Transmission"</i>
Transfer Request	Sends a document to a destination via a fax machine equipped with transfer station capability.	P.138 <i>"Transfer Request"</i>
TTI Print	You can have this identification printed on the header of all faxes sent from the machine.	P.141 <i>"TTI Print"</i>
Scanner Mode	This feature requires the optional PC-FAX Expander.	For details, please refer to the optional PC-FAX Expander manual.

Communication Information

Feature name	Description	Reference
Checking and Canceling Transmission Files	You can cancel, confirm, or change the settings for messages stored in memory with Memory Transmission, Confidential Transmission, Transfer Request, Polling Reception, or Polling Transmission.	P.143 <i>"Checking and Canceling Transmission Files"</i>
Printing the TX File List	Print this list to check on file numbers/files stored in memory.	P.149 <i>"Printing a List of Files in Memory (Print TX File List)"</i>
Viewing Transmission Status	You can view the transmission part of the Journal on the display. This lists the results of the last 50 transmissions.	P.150 <i>"Checking the Transmission Result (TX Status)"</i>
Viewing Reception Status	You can view the reception part of the Journal on the display. This lists the last 50 receptions.	P.151 <i>"Checking the Reception Result (RX Status)"</i>

Feature name	Description	Reference
Printing a Confidential Reception Document	Print messages received with the Confidential Reception feature.	P.152 <i>"Printing a Confidential Message"</i>
Printing a Memory Lock Document	Print messages received with the Memory Lock feature.	P.154 <i>"Printing a File Received with Memory Lock"</i>
Printing the Journal	Print the Journal to view the results of the last 50 communications.	P.156 <i>"Printing the Journal"</i>
Displaying Files in Memory	You can view the status of the memory on the display.	P.159 <i>"Displaying the Files in Memory"</i>
TX/RX File Save	When the TX/RX File In HD feature is turned on, you can search for, print out, and delete sent or received documents that have been stored in memory.	P.160 <i>"TX/RX File Save"</i>
Box File Manager	Three types of box are available: Personal Boxes, Information Boxes and Transfer Boxes.	P.169 <i>"Box File Manager Functions"</i>
Mail Reception	This feature requires the optional NIC FAX Kit.	For details, please refer to the optional NIC FAX Kit manual.

Fax Features

Feature name	Description	Reference
Registering and Deleting Quick Dials	Register destinations you send to on a frequent basis in a Quick Dial key for one-touch dialing.	P.194 <i>"Registering Quick Dials"</i> P.197 <i>"Deleting Quick Dials"</i>
Register and Deleting Group Dials	If you send messages to the same set of multiple destinations on a frequent basis, register them in a Group and you can recall them instantly.	P.199 <i>"Registering Groups"</i> P.208 <i>"Deleting Groups"</i>

Feature name	Description	Reference
Registering and Deleting Speed Dials	If you register destinations in Speed Dials, you can recall them instantly by pressing the Speed Dial key and then entering a 2 or 3-digit code.	P.209 <i>“Registering Speed Dials”</i> P.212 <i>“Deleting Speed Dials”</i>
Registering and Deleting Keystroke Programs	You can store combinations and of various settings, as well as a destination, in a Quick Dial key.	P.213 <i>“Storing Keystroke Programs”</i> P.217 <i>“Deleting a Keystroke Program”</i>
Registering and Deleting Auto Documents	If you scan in a document as an Auto Document, it is saved in memory and can be printed or sent without scanning it in again.	P.218 <i>“Registering Auto Documents”</i> P.221 <i>“Deleting an Auto Document”</i>
REPORTS/LISTS	You can print the following reports and lists manually: <ul style="list-style-type: none"> • Journal • Quick Dial List • Group Dial List • Speed Dial List • Keystroke Program List • Auto Document Originals 	P.223 <i>“Reports/Lists”</i>
User Function Keys	If you store a function name in a User Function key ([F1] to [F5]), you can jump to that function menu at a single keypress.	P.225 <i>“Assigning User Function Keys”</i>
Fax On Demand	This feature requires the optional Fax on Demand. Storing Fax On Demand Documents P.230 <i>“Registering/Editing Fax On Demand Documents”</i> Deleting Fax On Demand Documents P.232 <i>“Deleting Fax On Demand Documents”</i> Printing Fax On Demand Documents P.234 <i>“Printing Fax On Demand Documents”</i>	P.230 <i>“Fax On Demand”</i>

Key Operator Tools

Feature name	Description	Reference
Counters	You can check the total number of pages transmitted and received on the display.	P.244 <i>"Counters"</i>
Monitor Volume	You can adjust the volume of sounds the machine makes.	P.245 <i>"Monitor Volume"</i>
Adjusting the Display Contrast	You can adjust the contrast of the display panel.	P.246 <i>"Adjusting the Display Contrast"</i>
Date/Time	You can adjust the date and time of the machine's internal clock.	P.33 <i>"Date/Time"</i>
Summer Time/DST	Whenever local custom requires advancing the clock or setting the clock back, use this feature.	P.34 <i>"Summer Time/DST"</i>
Economy Transmission	You can have faxes queued in memory and sent automatically at a time when phone charges are lower.	P.247 <i>"Registering the Economy Transmission Time"</i>
Night Timer	Use this feature to have machine turn it's heater on and off automatically at the times that you prescribe.	P.248 <i>"Night Timer"</i>
Changing User Parameters	Allows you to customize various default settings to meet your needs.	P.250 <i>"Changing the User Parameters"</i>
Printing the User Parameter List	Allows you to print out and check a list of the User Parameter settings.	P.257 <i>"Printing the User Parameter List"</i>
File Retention	If a connection could not be made to the other party during a Memory Transmission even though the number was redialed the stipulated number of times, this setting specifies whether or not the file/document is preserved in memory.	P.258 <i>"File Retention"</i>

Feature name	Description	Reference
RTI/TTI	Register your RTI and TTI for identification purposes.	P.35 <i>"Registering your RTI and TTI"</i>
G3-1 Analog Line	Register your own analog telephone number, telephone line type, and CSI identification before you connect the machine to the G3 analog line.	P.259 <i>"G3-1 Analog Line"</i>
G3-2 Analog Line	Register the line type and CSI after you have installed the optional G3 Unit.	P.261 <i>"G3-2 Analog Line"</i>
G3 Digital Line	Register your own digital telephone number, sub-address and CSI before you connect the machine to the ISDN.	P.262 <i>"G3 Digital Line"</i>
G4 Digital Line	Register your own digital number, sub-address and TID (Terminal ID) before you connect the machine to a G4 digital line.	P.264 <i>"G4 Digital Line"</i>
ID Code	Register the IDs required for Transfer Request, Transfer Station, Default ID Polling Transmission, Default ID Polling Reception, and ID Transmission.	P.266 <i>"Registering ID Codes"</i>
Transfer Report	Store the fax number of the line your machine is connected to as the return address for when making transfer requests.	P.268 <i>"Transfer Report"</i>
Network Settings	This feature requires the optional NIC FAX Kit.	For details, please refer to the optional NIC FAX Kit manual.
System Parameter Transmission	Sends information about the condition of your machine to your nearest service representative.	P.270 <i>"System Parameter Transmission"</i>

Feature name	Description	Reference
Memory File Transfer	Use this feature to send all messages stored in memory to another fax machine and printed out there (e.g. if your machine cannot print for some reason).	P.270 <i>"Memory File Transfer"</i>
Resetting the PM Counters	Whenever you install the ADF Maintenance Kit or Fusing Maintenance Kit, clear this counter.	P.271 <i>"Reset PM Counters"</i>
Collate	Use this feature to have the machine print multiple copies of messages from certain senders. If no Specified Senders are registered, the machine prints multiple copies of all messages, regardless of the sender.	P.276 <i>"Collate"</i>
Authorized Reception	You can block out incoming messages from certain fax machines by registering them as Specified Senders.	P.278 <i>"Authorized Reception"</i>
Specified Tray	Have messages from certain senders printed on paper from a different tray.	P.281 <i>"Specified Tray"</i>
Forwarding	Have messages from certain senders forwarded automatically to another fax machine.	P.284 <i>"Forwarding"</i>
Memory Lock	Have messages from certain senders received into memory and not printed. To print these messages, you must enter an ID.	P.292 <i>"Memory Lock"</i>
TX/RX File In HD	Use this function to have messages from certain senders received using the TX/RX File Save function.	P.295 <i>"TX/RX File In HD"</i> TX/RX File Save
Backup Transmission Settings	By registering a destination for administrative use you can automatically have backups made of sent faxes.	P.300 <i>"Backup File Transmission Settings"</i> Backup Transmission Settings

Feature name	Description	Reference
Program Scan Area	Only the area of documents you have specified will be scanned in and sent.	P.302 " <i>Program Scan Area</i> " Program Area Settings
Box Settings	Three types of box are available: Personal Boxes, Information Boxes and Transfer Boxes.	P.304 " <i>Box Settings</i> " Box Settings

Specifications

Standard	G3, G4 (option)
Resolution	G3 Standard: 8 × 3.85 line/mm, Detail: 8 × 7.7 line/mm, Fine: 8 × 15.4 line/mm (Transmission only)
	G4 Standard: 8 × 3.85 line/mm, Detail: 8 × 7.7 line/mm, Fine: 8 × 15.4 line/mm (Transmission only)
Transmission Time	G3: 3 seconds (JBIG Communication Time: 2-3 seconds)
	G4: 3 seconds
Data Compression	MH, MR, MMR, SSC, JBIG (option required)
Maximum Scanning Width	304 mm/12"
Maximum Document Size	Document Feeder: 304 mm × 600 mm/12" × 23.6" Document Bypass Tray: 304 mm × 1200 mm/12" × 47.2"
Print Process	Printing on standard paper using the laser
Paper Size	A3 ☐, B4 ☐, A4 ☐☐, A5 ☐, F ☐, F4 ☐, Letter ☐
Transmission Speed	G3: 33,600/31,200/28,800/26,400/24,000/21,600/19,200/16,800/14,400/12,000/9,600/7,200/4,800/2,400bps (auto shift down system)
	G4: 64/56Kbps (auto speed matching)
Power Supply	187-276 Vac, 50Hz
Power Consumption	Transmission: 70W
	Reception: 400W
	Printing: Average 400W
	Fax Standby: 45W
	Low Power Standby: 2.0W
Maximum Power Consumption	900W
Dimensions	505 × 600 × 450 mm (W × D × H)
Weight	about 26.5 kg

Laser Label

Position of the Laser Label

Do not attempt any maintenance or troubleshooting other than that mentioned in this manual. This machine contains a laser beam generator and direct exposure to laser beams can cause permanent eye damage. For this reason, do not remove the cover. The laser generator exists inside the machine in the location shown by the arrow below.



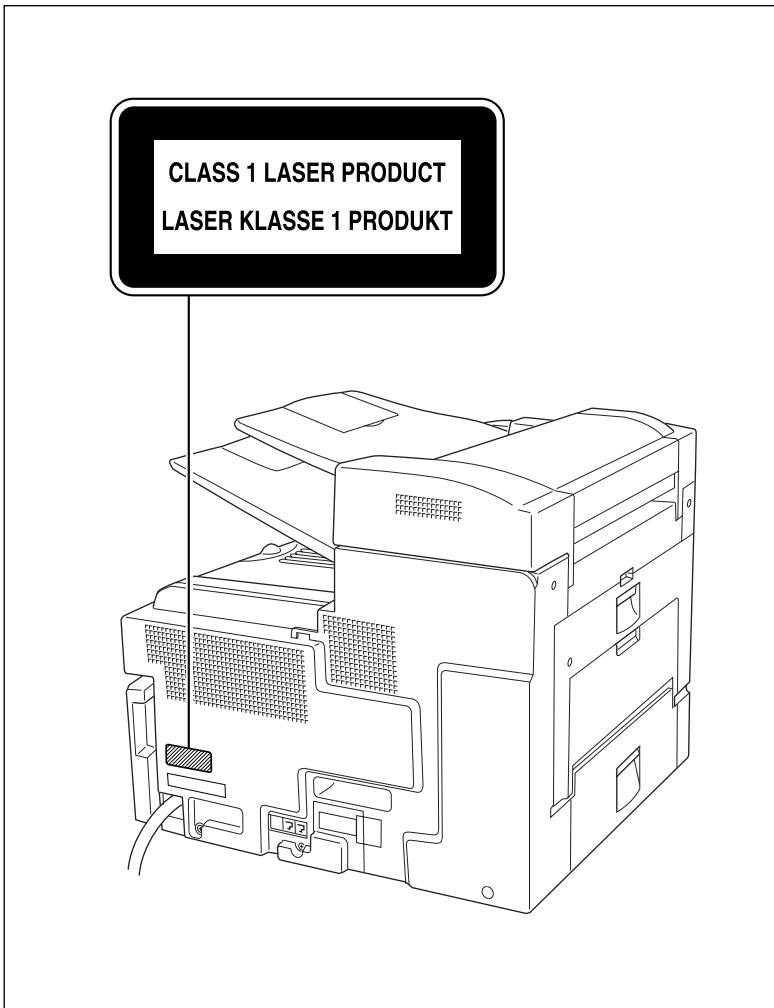

INDEX

A

Acceptable Copy Paper Sizes and Types, 53
Acceptable Types Of Documents, 47
Add Toner Indicator, 21
Adjusting Initial Settings, 32
Adjusting the Display Contrast, 246, 342
Adjusting the Printing Density, 41
Alarm, 22
Arrow Keys, 22
Authorized Reception, 110, 278, 344
Authorized Reception, Setup, 279
Auto Discriminate, 80
Auto Document, 98
Auto Document Feeder (ADF), 15
Auto Redial, 62, 69
Auto Reduction, 97
Available Characters, 319

B

Backup Transmission, 100
Backup Transmission Settings, 300, 344
Batch Transmission, 63
Boxes, 41
Box File Manager, 340
Box File Manager Functions, 169
Box Settings, 304, 345
Broadcasting, 60
Bypass Tray, 17

C

Call Service Indicator, 21
Canceling a Memory Transmission, 66
Canceling an Immediate Transmission, 72
Canceling a Transmission, 143
Center Mark, 112
Chain Dial, 87
Changing a destination, 147
Changing the Paper Size in the Main Paper Tray, 54
Changing the Paper Size in the Optional Paper Supply Unit, 56
Changing the Transmission Time, 146
Changing User Parameters, 342
Checked Mark, 112
Checking and Canceling Transmission

Files, 143, 339
Checking and Editing a File, 145
Checking Destinations (Destination List), 146
Checking the Reception Result (RX Status), 151
Checking the Transmission Result (TX Status), 150
CIL/TID Print, 115
Cleaning the Copy Paper Transport Mechanism, 326
Cleaning the Document Transport Mechanism, 325
Cleaning the Registration Roller, 327
Clearing Document Jams in the ADF, 180
Clearing Document Jams in the Bypass Tray, 181
Clearing Paper Jams in the Fusing Unit, 182
Clearing Paper Jams in the Main Paper Tray, 183
Clearing Paper Jams in the Optional Paper Supply Unit, 184
[Clear] Key, 22
[Clear Modes/Energy Saver] Key, 22
Collate, 113, 276, 344
Communicating, 22
Communicating Indicator, 20
Communication Failure Report, 65
Communication Result Report (Memory Transmission), 65
Communication Result Report (Polling Reception), 133
Confidential File Report, 153
Confidential ID, 266
Confidential Reception/Memory Lock Indicator, 20
Confidential Transmission, 120, 338
Copying, 175
[Copy] Key, 22
Corona Roller, 19
Counters, 244, 342
Cover Open Warning Indicator, 20
CSI, 36, 263

D

Data-in Indicator, 20
Date/Time, 33
Default ID Polling Reception, 131, 132

- Default ID Polling Transmission, 134, 135
- Deleting a Keystroke Program, 217
- Deleting an Auto Document, 221
- Deleting Fax On Demand Documents, 232
- Deleting Files, 167
- Deleting forwarding addresses, 288
- Deleting Groups, 208
- Deleting Information Boxes, 311
- Deleting Information Box Messages, 173
- Deleting Personal Boxes, 307
- Deleting Quick Dials, 197
- Deleting Specified Senders, 297
- Deleting Speed Dials, 212
- Deleting Transfer Boxes, 315
- Detail, 76
- Dialing, 81
- Dialing with Groups, 90
- Dialing with Quick Dials, 88
- Dialing with Speed Dials, 88
- Disk File Search List, 166
- Disk File Visual List, 166
- Displaying Files in Memory, 340
- Displaying the Files in Memory, 159
- Document Bypass Tray, 16
- Document Guides, 19
- Document Output Tray, 15, 28
- Document Tray, 15, 28
- Dual Access, 63
- Duplex Original Settings, 97

E

- ECM, 64, 69
- Economy Transmission Time, 118, 247, 342
- End Receiver, 106, 138
- Energy Saver, 22
- Energy Saver Mode, 39
- Entering Letters, 322
- Entering Numbers, 322
- Entering Symbols, 322
- Error Messages, 179
- Error Report, 191
- Extension, 79
- External Telephone Connector, 16

F

- Fax Features, 193, 340
- Faxing when toner has run out, 189
- Fax Mode (Auto Reception Mode), 105

- Fax On Demand, 230, 341
- Fax On Demand Recorded Messages, 237
- Fax Standby, 39
- Feed Unit, 19
- ferrite core, 30
- File Reserve Report (Memory Transmission), 64
- File Reserve Report (Polling Reception), 133
- File Retention, 258, 342
- Fine, 76
- Forwarding, 111, 284, 344
- Forwarding Mark, 285
- Free Polling Transmission, 134, 136
- Function Key Label, 196
- Function List, 338
- Fusing Unit, 18
- Fusing Unit Fixed Levers, 18

G

- G3, 79
- G3-1 Analog Line, 259, 343
- G3-2 Analog Line, 261, 343
- G3 Digital Line, 262, 343
- G4, 79
- G4 Digital Line, 264, 343
- Group Dial List, 207, 223

H

- Halftone, 76, 77
- [Halftone]** Key, 21
- How to Set a Document, 50

I

- ID Code, 343
- ID Override Polling Reception, 132
- ID Override Polling Transmission, 136
- ID Reception, 110
- ID Transmission, 99
- Image Density, 77
- Image density, 76
- [Image Density]** Key, 21
- Image Rotation, 114
- Immediate Reception, 101
- Immediate Transmission, 69
- Indicators, 188
- Information Boxes, 43
- ISDN, 336

J

JBIG Reception, 110
JBIG Transmission, 100
Journal, 156, 223

K

Key Operator Tools, 243, 342
Keystroke Program List, 217, 223

L

Label Insertion, 98
Laser Label, 347
Letters, 322
[Line Selection] Key, 21
Line Type, 36
Loading Paper in the Main Paper Tray, 31
Loading Paper in the optional Paper Supply Unit, 32
Low Power Standby, 39

M

Mail Reception, 340
Main Paper Cassette, 326
Main Paper Tray, 15, 17
Main Side Cover, 17, 18
Maintaining the Machine, 325
Maintaining Your Machine, 325
Maintenance Kits, 327
Manual Dial, 75
Memory File Transfer, 270, 344
Memory Lock, 292, 344
Memory Lock ID, 267
Memory Reception, 102
Memory Transmission, 60
Monitor Volume, 245, 342
Multi-Port Unit, 46
Multi-step Transfer, 106
Multi-step Transfer Group settings, 203

N

Network Settings, 269, 343
Night Timer, 248, 342
No Document, No Dial, 96
Number Keys, 22, 81
Numbers, 322

O

On-Hook Dial, 73
[On Hook] Key, 22
Online Indicator, 20
Operation Panel, 15
Optional Card Insertion Slots, 15
Optional Paper Supply Unit, 17
Output density, 41
Output Tray, 15
Override ID Polling Reception, 131
Override ID Polling Transmission, 134

P

Page Separation and Length Reduction, 115
Paper Jammed Indicator, 21
Paper Supply Indicator, 15
Paper Supply Unit Side Cover, 17
Paper Tray Side Cover, 17
Parallel Memory Transmission, 64
Pause, 82
[Pause/Redial] Key, 22
Personal Boxes, 42
Personal Code Transmission, 122, 338
Polling ID, 266
Polling Reception, 131, 338
Polling Transmission, 134, 339
Polling Transmission Clear Report, 137
Power Indicator, 20
Power Switch, 15
Pressure Release Levers, 18
Printing a Confidential Message, 152
Printing a Confidential Reception Document, 340
Printing a File, 144
Printing a File Received with Memory Lock, 154
Printing a List of Files in Memory (Print TX File List), 149
Printing a Memory Lock Document, 340
Printing Fax On Demand Documents, 234
Printing Files, 166
Printing Functions, 112
Printing Information Box Messages, 171
Printing Personal Box Messages, 169
Printing the Box List, 316
Printing the Fax On Demand Access Report, 236
Printing the Fax On Demand List, 235

Printing the Journal, 156, 340
Printing the Specified Sender List, 299
Printing the TX File List, 339
Printing the User Parameter List, 342
Program/Delete, 194
Program Scan Area, 302, 345

Q

Quick Dial, 81
Quick Dial Key Flip Plate, 21
Quick Dial Keys, 21
Quick Dial List, 196, 223
Quick key label, 196

R

RDS (Remote Diagnostic System), 273
Receive File Indicator, 20, 188
Reception Functions, 106
Reception Mode Key, 21
Reception Time, 112
Redialing Numbers, 92
Register and Deleting Group Dials, 340
Registering and Deleting
 Speed Dials, 341
Registering and Deleting Auto Documents, 341
Registering and Deleting Keystroke Programs, 341
Registering and Deleting Quick Dials, 340
Registering Auto Document, 218
Registering/Editing Fax On Demand Documents, 230
Registering/Editing Information Boxes, 309
Registering/Editing Personal Boxes, 304
Registering/Editing Transfer Boxes, 312
Registering Groups, 199
Registering ID Codes, 266
Registering Quick Dial, 194
Registering Speed Dial, 209
Remote Transfer, 107
Remote Transfer with UUI, 109
Replacing the Stamp Cartridge, 331
Replacing the Toner Cartridge, 186
Reports/Lists, 223, 341
Requesting Party, 106, 138
Re-sending a file, 146
Reset, 22
Reset PM Counter, 344

Reset PM Counters, 271
Resolution, 76
 [Resolution] Key, 21
Restricted Access, 44
Rotate Sort, 114
RTI, 35
RTI/TTI, 343

S

Scanner Mode, 339
Scan Settings, 76
Searching Memory for Received Faxes, 163
Searching Memory for Sent Faxes, 161
Selecting the Line, 79
Selecting the Reception Mode, 105
Selection Keys, 22
Sending a Fax Using a Program, 94
Send Later, 118, 338
Separation Roller, 19
SEP Code Polling Reception, 128, 338
SEP Code Polling Transmission, 85
Setting Paper in the Document Bypass Tray, 51
Setting up Collate, 277
Setting up Memory Forwarding, 285
Setting up Memory Lock, 293
Setting Up Specified Tray, 282
Setting Up TX/RX File In HD, 295
Skip Transmission, 99
Solving Problems, 177
Specifications, 346
Specified Senders, 275
Specified Tray, 110, 344
Specified tray, 281
Specifying an End Receiver, 140
Speed Dial, 81
 [Speed Dial] Key, 22
Speed Dial List, 212, 223
Stamp, 96
 [Stamp] Key, 21
Standard, 76
Standby Display, 25
 [Start] Key, 22
Status Indicators, 22
 [Stop] Key, 22
Storing Keystroke Program, 213
Storing Messages in Information Boxes, 170
Sub-address, 87
Sub Code Transmission, 83

SUB Code Transmission with the Mode Key, 125
SUB/SID Transmission, 338
Substitute Reception, 103
Summer Time, 34
Summer Time/DST, 342
Switches and Bits, 250
Switching Language, 32
System Parameter Transmission, 270, 343
System Settings, 244

T

Telephone Directory, 89
Telephone Line Connector, 16
Telephone Mode, 105
tonal signals, 83
Tone, 83
Toner Cartridge, 18, 28
Toner saving, 41
Tone Signals, 83
To Specify Group Number, 91
Transfer Boxes, 43
Transfer Report, 268, 343
Transfer Request, 138, 339
Transfer Result Report, 107
Transfer Roller, 18
Transfer Roller Cover, 18
Transfer Station, 106, 138
Transmission Features, 96
【Transmission Mode】Key, 21
Transmission Result Report, 71
Troubleshooting, 177
TSI Print, 115
TTI, 35
TTI/CIL Print, 99
TTI Print, 141, 339
Two In One, 113
TX/RX File In HD, 295, 344
TX/RX File Save, 45, 160, 340

U

User Function Keys, 21, 225, 341
User Parameter List, 251
User Parameters, 250
【User Tools】Key, 21

V

Viewing Reception Results, 339
Viewing Transmission Status, 339

W

When the Add Toner Indicator is Lit or Flashing, 189
When the Call Service Indicator is Lit, 190
When the Confidential Reception/Memory Lock Indicator is Lit or Flashing, 188
When the Cover Open Warning Indicator Is Lit, 189
When the Paper Jammed Indicator is Lit, 189
When the Paper Supply Indicator is Lit, 190
When the Receive File Indicator is Lit, 188
Wildcards, 275, 320

